

DER RÄDERKOMPASS

2015/2016



KRONPRINZ
MAGMA

KRONPRINZ

Das serienidentische Stahlrad.

ACHTUNG! Eine KBA-Nummer alleine ist noch kein Qualitätsmerkmal!

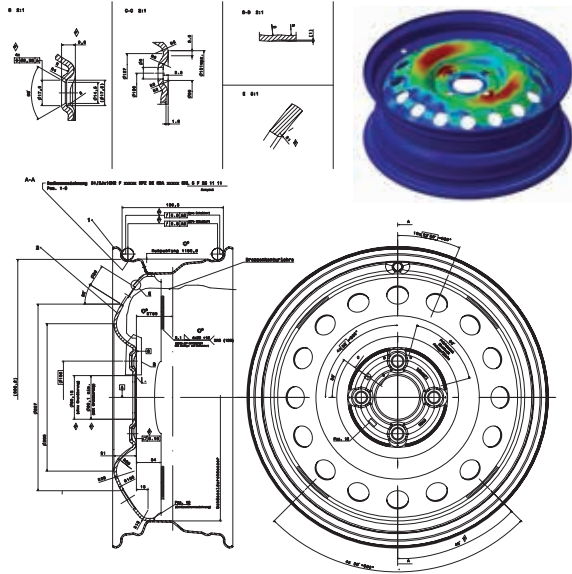

Dieses alles muss ein serienidentisches Stahlrad im Vergleich zu den in der Erstausrüstung eingesetzten Stahlrädern erfüllen:

- **absolute Identität aller Funktionsmaße**
- **absolute optische Identität**
- **gleicher Werkstoff**
- **gleiche Radlast bzw. Tragfähigkeit**

Die von KRONPRINZ angebotenen Stahlräder sind serienidentisch:

- sie erfüllen die Anforderungen der StVZO
- sie entsprechen zu 100% den Serienrädern in der Fahrzeug-ABE
- sie erfüllen die für die einzelnen Fahrzeugmodelle geforderten Radlasten
- sie erfüllen die Qualitätsstandards der Fahrzeughersteller
- sie lassen sich ohne Wenn und Aber zuordnen und verbauen
- sie sind von der Mitführungspflicht der ABE befreit

Weitere Informationen unter: www.identrad.de

Seite

Erläuterung zur Nutzung des RäderKompass

Das Fahrzeug / Stahlrad-Modul bzw. Leichtmetallrad-Modul	2
RDKS-Abkürzungen	3

Schnellübersicht Stahlräder für Pkw und Lkw

nach Artikelnummern geordnet	4 - 20
------------------------------------	--------

**Fahrzeug / Radzuordnungen Stahl- und Leichtmetallräder Pkw und Lkw
mit zulässigen Reifenabmessungen und RDKS-Freigaben**

nach Fahrzeugherstellern und -typen geordnet	21 - 295
--	----------

MAGMA-Zubehör

Zubehör-Kits	296 - 298
Felgenschlösser	298
Nabenkappen	299

Räder für Lkw und Lkw-Anhänger	300 - 304
---	-----------

Räder für Pkw-Anhänger	305
-------------------------------------	-----

Allgemeine Informationen zum Rad

Die Räderrichtlinie	306 - 307
Sicherheits- und Wartungshinweise für den Gebrauch von Rädern in Reifenwerkstätten	308 - 310

KRONPRINZ Vertriebspartner

national / international	www.kronprinz-raederport.com
--------------------------------	--

Modell	Artikelnummer	Vergleichsnummern	Baujahr	Typbezeichnung	Karosserieausführung	Motorausführung
Astra-J / Sports Tourer			11/09-09/15			P-J, P-J/SW, P-J/V, P-J/SW/V
OP 516014	9327	163334		Schräg-/Stufenheck, Sports Tourer		
6½ J x16 H2	205/55R16			1,7 CDTi (81/92 kW)		
5x115x70,3	205/60R16			1,6 CDTi (81/100/110 kW) / 1,7 CDTi (81/92/96 kW) / 2,0 CDTi (118/121 kW) / 1,6T (125/132 kW)		
ET 41	215/60R16					
€ 81,40	Kegel sw 19 M12 x 1,5					
RDKS	ASC; ASS; CUC; Huf 2.4; Huf 3.4; Huf 3.5; SE1C1; SE1C2; SE2C1; SE2C2; SE1S; SE2S; TTC; TTS / OE: Schrader 3033			FZG-Schein beachten: Je nach Ausführung unterschiedliche Reifenabmessungen zulässig. Einige Ausführungen auch 205/65R16 zulässig. Für Fahrzeuge mit Anschluss: 5x115x70,3. Nicht 2,0 CDTi (143 kW).		

mögliche Reifendruckkontrollsysteme (RDKS) Radbefestigung mögliche Reifenabmessungen

KB-Preis Radabmessung / LZ x LK x ML / Einpresstiefe Erläuterungen / Einschränkungen bei Rädern, Reifen oder Radbefestigungen





Modell	Design	Artikelnummer	Farbvariante	Typbezeichnung
Astra-J / Sports Tourer				P-J, P-J/SW, P-J/V, P-J/SW/V
Celsio		CS 656 40 5 15	lichtsilber-lackiert	
Tezzo		TZ 656 40 5 15	lichtsilber-lackiert / mattschwarz-lackiert	
6½ J x16 H2		205/60R16 ※	ABE	Lochkreis beachten 5 x 115
5 x 115		215/60R16 ※	ABE	
ET 40				
RDKS	Celsio: ASC; ASS; CUC; Huf 2.4; Huf 3.4; Huf 3.5; SE1C1; SE1C2; SE1S; TTC; TTS / OE: Schrader 3033 Tezzo: ASC; ASS; CUC; Huf 2.4; Huf 3.4; Huf 3.5; SE1C1; SE1C2; SE1S; TTC / OE: Schrader 3033			MK 048

mögliche Reifendruckkontrollsysteme (RDKS) ABE- bzw. TÜV-Freigabe

Radabmessung / LZ x LK / Einpresstiefe mögliche Reifenabmessungen | ※ = Schneekettenfreigabe (Weitere Reifengrößen können möglich sein. Alle zulässigen Reifengrößen sind in der jeweiligen ABE eingetragen.) Zubehör-Kit inkl. Zentriering und Schrauben bzw. Muttern

Erläuterungen / Einschränkungen zu Rädern, Reifen oder Radbefestigungen

Stahlräder

Die Angaben zur Serienbereifung für Sommer- und Winterbetrieb (M+S) entsprechen den Angaben in den Fahrzeugpapieren oder der EWG-Übereinstimmungsbescheinigung (CoC-Papier). Bei mehreren möglichen Reifenabmessungen wird hier immer die schmalste bzw. gängigste angegeben. Maßgebend für die am Fahrzeug zu verwendende Rad/Reifenkombination sind immer die Angaben in den Fahrzeugpapieren oder die Angaben des Fahrzeugherstellers in der EWG-Übereinstimmungsbescheinigung (CoC-Papier).

MAGMA-Leichtmetallräder

Maßgebend für die Verwendung einzelner Rad- bzw. Reifenabmessungen sind bei MAGMA-Leichtmetallrädern immer die Angaben in der jeweiligen ABE bzw. dem TÜV-Gutachten. Bei Rädern, die mit „ABE“ gekennzeichnet sind, ist keine TÜV-Vorfürung und Eintragung in die Fahrzeugpapiere nötig, sofern laut ABE keine sonstigen Änderungen (z. B. Karosserieauflagen) am Fahrzeug vorgenommen werden müssen.

AFTER-MARKET RDKS			OE-RDKS
In unseren Katalogen verwendete Abkürzungen für RDK-After-Market-Systeme			(auch im Aftermarket erhältlich)
Universal-Sensor	Vorprogrammierter Sensor mit variabler ID	Vorprogrammierter Sensor mit fixer ID	Vorprogrammierter Sensor für ein/e Fahrzeug-gruppe
ASC = Alligator • sens.it • clamp in	CUC = Cub • UNI SENSOR • clamp in	zur Zeit nur VDO REDI-Sensor	Bei OE-Systemen verwenden wir keine Abkürzungen sondern nennen Ihnen die Artikelnummer des RDKS-Herstellers.
ASS = Alligator • sens.it • snap in	CUS = Cub • UNI SENSOR • snap in	Montage im Reifen	
SE1C1 = Schrader • EZ-Sensor Generation 1 • clamp in • Art.-Nr. 2000	Huf 2.4 = HUF • IntelliSens • clamp in UVS02C4		
SE1C2 = Schrader • EZ-Sensor Generation 1 • clamp in • Art.-Nr. 2020	Huf 3.4 = HUF • IntelliSens • clamp in UVS01C4/UVS09C4		
SE2C1 = Schrader • EZ-Sensor Generation 2 • clamp in variabler Winkel • Art.-Nr. 2200	Huf 3.5 = HUF • IntelliSens • snap in UVS02S4		
SE2C2 = Schrader • EZ-Sensor Generation 2 • clamp in fester Winkel • Art.-Nr. 2210	TTC = TECH • T-Pro • clamp in		
SE1S = Schrader • EZ-Sensor Generation 1 • snap in	TTS = TECH • T-Pro • snap in		
SE2S = Schrader • EZ-Sensor Generation 2 • snap in			



Unsere RDKS-Freigaben beziehen sich auf die Verbaubarkeit in unseren Stahl- und Leichtmetallrädern. Soweit vorhanden, haben wir uns bei der Analyse und Beurteilung der Einbauverhältnisse an den Vorgaben der RDKS-Hersteller orientiert.

Die Freigaben basieren auf unserem Informationsstand Mitte Juli 2015. In der Zukunft können sich jederzeit Än-

derungen oder neue Zuordnungen ergeben. Das gilt insbesondere für die von den Automobilherstellern in Serie verwendeten Sensoren.

Wir empfehlen, entsprechend den Vorgaben in der ETRTO, bei Fahrzeugen mit einer größeren Höchstgeschwindigkeit als 210 km/h ausschließlich RDK-Systeme mit Metallventilen (Clamp In) zu verwenden.

Schnellübersicht

	Artikelnummer	Fahrzeughersteller	Fahrzeugmodell/Baujahr	Rädergröße	KB-Preis in €
*	AD 515008	Audi	A4 -11/00; A6 -04/97; A6 05/97-05/99	6 J x15 H2	65,50
*	AD 515008	VW	Passat 10/96-10/00; Passat 11/00-02/05	6 J x15 H2	65,50
*	AD 515010	VW	Passat Facelift 11/00-02/05	6 J x15 H2	65,50
R	AD 515015	Audi	A1 09/10-	6 J x15 H2	64,50
R	AD 515016	Audi	A1 09/10-	6½ J x15 H2	64,50
*	AD 516004	Audi	A6 08/99-04/04	6 J x16 H2	81,40
*	AD 516004	Skoda	Superb 03/02-06/08	6 J x16 H2	81,40
*	AD 516004	VW	Passat 11/00-02/05	6 J x16 H2	81,40
	AD 516011	Audi	A4 12/00-10/04; A4 11/04-10/07 (nicht für 6 Zylinder und 2.0 TFSI 147 kW)	7 J x16 H2	78,20
R	AD 516012	Audi	A3 05/03-08/12; A3 Sportback 09/04-01/13	6 J x16 H2	74,50
R	AD 516012	Seat	Leon 09/05-11/12	6 J x16 H2	74,50
R	AD 516012	Skoda	Yeti 10/09-	6 J x16 H2	74,50
R	AD 516012	VW	Golf V 10/03-09/08; Golf V GTI 11/04-05/09; Golf VI 10/08-10/12; Golf VI Cabrio 06/11-; Jetta 08/05-12/10; Jetta 01/11-; Touran 03/03-08/15; Cross Touran 05/09-	6 J x16 H2	74,50
R	AD 516014	Audi	A4 11/07-10/15 (88-118 kW); A4 11/07-10/15 (Sonderrad mit ABE: 88-195 kW)	7 J x16 H2	77,70
	AD 516016	Audi	A3 Cabrio 03/14-; A3 Limousine 06/13-	6½ J x16 H2	78,50
	AR 516003	Alfa Romeo	159 01/08-12/12	7 J x16 H2	91,80
	AR 516005	Alfa Romeo	MiTo 07/08-	7 J x16 H2	87,70
	AR 516007	Alfa Romeo	Giulietta 04/10-	7 J x16 H2	87,70
	BM 515015	Mini	Clubman 11/07-10/15; Mini II 10/01-02/14	5½ J x15 H2	70,80
R	BM 515019	BMW	Mini III 03/14-	5½ J x15 H2	70,80
	BM 516018	BMW	1er-Reihe 05/07-09/11	6½ J x16 EH2+	81,40
	BM 516019	BMW	1er-Reihe 05/07-09/11; 1er-Reihe Cabrio 03/08-02/14; 1er-Reihe Coupé 11/07-02/14	7 J x16 EH2+	80,80
	BM 516020	BMW	3er-Reihe 09/07-02/12	7 J x16 EH2+	84,00
*	BM 516021	BMW	1er-Reihe 10/11-07/13	6½ J x16 H2	80,80
*	BM 516023	BMW	3er-Reihe 03/12-07/13	7 J x16 H2	84,00
	BM 516024	Mini	Countryman 09/10-; Paceman 03/13-	6½ J x16 H2	80,80
R	BM 516025	BMW	1er-Reihe 08/13-; Ersetzt BM 516021	6½ J x16 H2	80,80
R	BM 516026	BMW	1er-Reihe 08/13-; 2er-Reihe 03/14-; Ersetzt BM 516022	7 J x16 H2	80,80

Mit * gekennzeichnete Räder sind nur noch im Rahmen verfügbarer Lagerbestände lieferbar. | R = Renner

	Artikelnummer	Fahrzeughersteller	Fahrzeugmodell/Baujahr	Rädergröße	KB-Preis in €
R	BM 516027	BMW	3er-Reihe 08/13-; Ersetzt BM 516023	7 Jx16 H2	84,00
	BM 516029	BMW	2er Active Tourer 09/14-06/15 (nicht Gran Tourer); Serienrad mit Flow-Form-Felge	7 Jx16 H2	80,80
R	BM 517005	BMW	X1 10/09-09/15	7½ Jx17 EH2+	105,10
	CH 516003	Chrysler	Grand Voyager 04/08-11/11	6½ Jx16 CH	97,20
	CV 513001	Chevrolet	Spark 03/10- (Sonderrad mit ABE)	4½ Jx13 H2	52,30
	CV 514001	Chevrolet	Spark 03/10-	4½ Jx14 H2	62,30
	CV 515001	Chevrolet	Aveo 10/11-; 4-Loch	6 Jx15 H2	71,30
	CV 515002	Chevrolet	Aveo 10/11-; 5-Loch	6 Jx15 H2	71,30
	DA 513005	Daihatsu	Cuore 09/03-06/07; Cuore 07/07-01/13; Trevis 08/06-01/13	4.00 B x13 H2	69,20
	DJ 513001	Daihatsu	Matiz 09/98-02/10	4½ Jx13 H2	51,80
	DJ 513001	Daewoo	Matiz 09/98-02/10	4½ Jx13 H2	51,80
	DJ 513002	Chevrolet	Kalos 09/02-04/08; Aveo 02/06-09/11 (Stufenheck); Aveo 05/08-09/11 (Schrägheck)	5 Jx13 CH	57,10
	DJ 514002	Chevrolet	Kalos 09/02-04/08; Aveo 02/06-09/11 (Stufenheck); Aveo 05/08-09/11 (Schrägheck)	5½ Jx14 H2	69,70
	DJ 514003	Chevrolet	Lacetti 03/04-02/09; Nubira J200 07/03-02/09; Rezzo 03/01-09/08	5½ Jx14 H2	69,70
	DJ 514003	Daewoo	Lacetti 03/04-12/10; Nubira J200 07/03-02/09; Rezzo 03/01-09/08	5½ Jx14 H2	69,70
	DJ 515003	Chevrolet	Lacetti 03/04-02/09; Nubira J200 07/03-02/09; Rezzo 03/01-09/08	6 Jx15 CH	79,20
	DJ 515003	Daewoo	Lacetti 03/04-12/10; Nubira J200 07/03-02/09; Rezzo 03/01-09/08	6 Jx15 CH	79,20
*	DJ 515004	Chevrolet	Evanda 04/03-06/06; Epica 07/06-12/11	6 Jx15 CH	79,20
*	DJ 515004	Daewoo	Evanda 04/03-06/06; Epica 07/06-12/11	6 Jx15 CH	79,20
	FL 513011	Fiat	Panda 11/03-01/12; Panda Classic 02/12-	5.00 B x13 H	51,30
	FL 514018	Fiat	Panda 4x4 09/03-01/12; Panda 4x4 Classic 02/12-; Punto 09/99-01/07	5½ Jx14 H2	56,50
R	FL 514026	Fiat	500 09/07-; Panda 02/12-	5½ Jx14 H2	56,50
R	FL 514026	Ford	Ka 02/09-	5½ Jx14 H2	56,50
	FL 515008	Fiat	Stilo 09/01-03/07; Stilo Multi Wagon 09/01-05/08	6½ Jx15 H2	67,60
	FL 515009	Fiat	500 09/07-; Idea 01/04-10/11	6 Jx15 H2	74,00
	FL 515009	Ford	Ka 02/09-	6 Jx15 H2	74,00
	FL 515009	Lancia	Musa 10/04-07/12; Ypsilon 09/03-06/11	6 Jx15 H2	74,00
R	FL 515010	Fiat	Grande Punto 10/05-09/09; Punto Evo 10/09-	6 Jx15 H2	66,00
	FL 515012	Fiat	Bravo 04/07-07/14	6 Jx15 H2	66,60

Mit * gekennzeichnete Räder sind nur noch im Rahmen verfügbarer Lagerbestände lieferbar. | R = Renner

	Artikelnummer	Fahrzeughersteller	Fahrzeugmodell/Baujahr	Rädergröße	KB-Preis in €
	FL 515013	Citroën Lkw	Nemo 02/08-	6 J x15 H2	66,60
	FL 515013	Fiat	Linea 07/07-	6 J x15 H2	66,60
	FL 515013	Fiat Lkw	Fiorino 02/08-	6 J x15 H2	66,60
	FL 515013	Peugeot Lkw	Bipper 02/08-	6 J x15 H2	66,60
	FL 515021	Lancia	Ypsilon 07/11-	6 J x15 H2	77,30
	FL 515023	Fiat	Panda 4x4 03/13-	6 J x15 H2	66,60
	FL 515024	Fiat	500 L 10/12-; 500 L Living/Trekking 06/13- (nicht 70 kW / 88 kW)	6 J x15 H2	66,60
*	FL 516002	Fiat Lkw	Doblo 02/10-10/14	6 J x16 H2	79,80
*	FL 516002	Opel Lkw	Combo-D 04/12-	6 J x16 H2	79,80
	FL 516004	Fiat	Bravo 04/07-07/14	7 J x16 H2	87,70
	FL 516004	Lancia	Delta 04/08-12/14	7 J x16 H2	87,70
	FL 516006	Dodge	Journey 07/08-12/10	6½ J x16 H2	89,20
	FL 516006	Fiat	Freemont 09/11-	6½ J x16 H2	89,20
	FL 516007	Fiat	500 L 10/12-; 500 L Living/Trekking 06/13- (nicht 70 kW / 88 kW)	6 J x16 H2	79,80
	FL 516008	Fiat	500X 01/15-	6½ J x16 H2	79,80
	FL 614003	Fiat Lkw	Doblo Facelift 10/05-01/10; verstärkte Radausführung	5½ J x14 H2	60,00
	FL 614004	Citroën Lkw	Nemo 02/08-	5½ J x14 H2	58,10
	FL 614004	Fiat Lkw	Fiorino 02/08-	5½ J x14 H2	58,10
	FL 614004	Peugeot Lkw	Bipper 02/08-	5½ J x14 H2	58,10
*	FL 615001	Citroën Lkw	Jumper 03/94-05/06	6 J x15 H2	94,00
*	FL 615001	Fiat Lkw	Ducato 03/94-05/06	6 J x15 H2	94,00
*	FL 615001	Peugeot Lkw	Boxer 03/94-05/06	6 J x15 H2	94,00
*	FL 615002	Citroën Lkw	Jumper 06/06-04/14; Wird ersetzt durch FL 615007	6 J x15 H2	94,00
*	FL 615002	Fiat Lkw	Ducato 06/06-04/14; Wird ersetzt durch FL 615007	6 J x15 H2	94,00
*	FL 615002	Peugeot Lkw	Boxer 06/06-04/14; Wird ersetzt durch FL 615007	6 J x15 H2	94,00
	FL 615004	Fiat Lkw	Doblo Facelift 10/05-01/10; verstärkte Radausführung	5½ J x15 H2	71,90
	FL 615006	Fiat Lkw	Doblo 02/10-	6 J x15 H2	72,40
	FL 615006	Opel Lkw	Combo-D 04/12-	6 J x15 H2	72,40
	FL 615007	Citroën Lkw	Jumper 06/06-04/14; Jumper 05/14- (MJ 2014); Ersetzt FL 615002	6 J x15 H2	94,00
	FL 615007	Fiat Lkw	Ducato 06/06-04/14; Ducato 05/14- (MJ 2014); Ersetzt FL 615002	6 J x15 H2	94,00
	FL 615007	Peugeot Lkw	Boxer 06/06-04/14; Boxer 05/14- (MJ 2014); Ersetzt FL 615002	6 J x15 H2	94,00
*	FL 616002	Citroën Lkw	Jumper 03/94-05/06	6 J x16 H2	107,80
*	FL 616002	Fiat Lkw	Ducato 03/94-05/06	6 J x16 H2	107,80

Mit * gekennzeichnete Räder sind nur noch im Rahmen verfügbarer Lagerbestände lieferbar. | R = Renner

	Artikelnummer	Fahrzeughersteller	Fahrzeugmodell/Baujahr	Rädergröße	KB-Preis in €
*	FL 616002	Peugeot Lkw	Boxer 03/94-05/06	6 J x16 H2	107,80
	FL 616004	Citroën Lkw	Jumper (Heavy) 06/06-04/14	6 J x16 H2	107,80
	FL 616004	Fiat Lkw	Ducato (Maxi) 06/06-04/14	6 J x16 H2	107,80
	FL 616004	Peugeot Lkw	Boxer (Heavy) 06/06-04/14	6 J x16 H2	107,80
	FL 616007	Fiat	500 L Living/Trekking 06/13- (70 kW / 88 kW); Doblo 11/14-; Ersetzt FL 516002	6 J x16 H2	79,80
	FL 616007	Opel Lkw	Combo-D 04/12-; Ersetzt FL 516002	6 J x16 H2	79,80
Neu	FL 616008	Citroën	Jumper 05/14- (MJ 2014)	6 J x16 H2	107,80
Neu	FL 616008	Fiat Lkw	Ducato 05/14- (MJ 2014)	6 J x16 H2	107,80
Neu	FL 616008	Peugeot	Boxer 05/14- (MJ 2014)	6 J x16 H2	107,80
Neu	FL 616009	Citroën	Jumper (Heavy) 05/14- (MJ 2014)	6 J x16 H2	107,80
Neu	FL 616009	Fiat Lkw	Ducato (Maxi) 05/14- (MJ 2014)	6 J x16 H2	107,80
Neu	FL 616009	Peugeot	Boxer (Heavy) 05/14- (MJ 2014)	6 J x16 H2	107,80
	FO 514007	Ford	Focus I 10/98-11/04	5½ J x14 CH	57,10
	FO 514010	Ford	Fiesta 04/02-05/08; Fusion 10/02-06/12; Fiesta Van 08/07-04/10	5½ J x14 H2	57,10
	FO 514010	Mazda	Mazda 2 04/03-09/07	5½ J x14 H2	57,10
R	FO 514011	Ford	Fiesta 10/08-; Fiesta Van 05/10-	5½ J x14 H2	57,10
	FO 515007	Ford	Fiesta 04/02-05/08; Fiesta Van 08/07-04/10; Focus I 10/98-11/04; Fusion 10/02-06/12	6 J x15 H2	63,40
R	FO 515014	Ford	Focus II 12/04-02/11; C-Max 06/03-07/07; C-Max 05/07-09/10	6 J x15 H2	63,40
	FO 515015	Ford	Fiesta 10/08-; Fiesta Van 05/10-	6 J x15 H2	63,40
*	FO 515016	Ford	B-Max 09/12-10/14	6 J x15 H2	63,40
	FO 515017	Ford	B-Max 11/14-	6 J x15 H2	63,40
	FO 515018	Ford	EcoSport 06/14-	6 J x15 H2	63,40
	FO 516005	Ford	Focus II 12/04-01/08; Mondeo Facelift 07/03-06/07; C-Max 06/03-04/07; C-Max 05/07-09/10	6½ J x16 H2	75,50
R	FO 516007	Ford	Galaxy 07/06-06/15; S-Max 06/06-06/15	6½ J x16 H2	80,30
R	FO 516008	Ford	Focus II 02/08-02/11; Focus III 03/11-; C-Max 05/07-09/10; C-Max 11/10-; Grand C-Max 11/10-; Mondeo 06/07-01/15; Mondeo 02/15-; Kuga 06/08-12/12	6½ J x16 H2	75,00
Neu	FO 517004	Ford	Galaxy 07/15-; S-Max 07/15-	7½ J x17 H2	90,50
	FO 615005	Ford Lkw	Transit 01/01-05/06 (VE 185, Frontantrieb); Transit 06/06-04/14 (Frontantrieb)	5½ J x15 H2	86,60

Mit * gekennzeichnete Räder sind nur noch im Rahmen verfügbarer Lagerbestände lieferbar. | R = Renner

	Artikelnummer	Fahrzeughersteller	Fahrzeugmodell/Baujahr	Rädergröße	KB-Preis in €
	FO 615006	Ford Lkw	Tourneo Connect 03/03-03/14; Transit Connect 03/03-03/14	6 J x15 H2	71,30
	FO 615009	Ford Lkw	Tourneo Custom 01/13-; Transit Custom 01/13-; Transit 05/14-	6½ J x15 H2	87,60
	FO 615010	Ford Lkw	Tourneo Courier 04/14-; Transit Courier 04/14-	6 J x15 H2	71,30
	FO 616006	Ford Lkw	Transit 10/02-05/06 (V 184, Single); Transit 06/06-04/14 (Heckantrieb)	5½ J x16 H2	94,00
	FO 616007	Ford	Transit Zwilling (V.....) 06/06-04/14	5 J x16 H2	101,40
	FO 616009	Ford Lkw	Tourneo Custom 01/13-; Transit Custom 01/13-; Transit 05/14-	6½ J x16 H2	95,00
	FO 616010	Ford	Kuga II 01/13-	6½ J x16 H2	79,80
	FO 616010	Ford Lkw	Tourneo Connect 04/14-; Transit Connect 04/14-	6½ J x16 H2	79,80
	FO 616011	Ford Lkw	Transit 05/14-; Zwillingsbereifung	6 J x16 H2	101,40
	HO 514012	Honda	Jazz 03/04-10/08 (bei Fahrzeugen mit Scheibenbremsen hinten)	5½ J x14 H2	68,20
	HO 515016	Honda	Jazz 11/08-08/15; Insight 04/09-	5½ J x15 H2	72,40
Neu	HO 515019	Honda	Jazz 09/15-	5½ J x15 H2	72,90
	HO 516006	Honda	Civic 03/06-01/12	6½ J x16 H2	83,50
	HO 516007	Honda	Accord 07/08-06/15	6½ J x16 H2	90,30
	HO 516009	Honda	Civic 02/12-	6½ J x16 H2	83,50
	HY 513007	Hyundai	Atos 02/01-02/08; Getz 09/02-12/08; Accent 01/00-05/06	5 J x13 CH	63,90
	HY 513009	Hyundai	i10 12/13-	4½ J x13 H2	59,90
	HY 514005	Hyundai	Getz 09/02-12/08; Accent 01/00-05/06	5 J x14 CH	71,90
	HY 514008	Hyundai	i20 01/09-12/14 (IND)	5 J x14 CH	69,20
	HY 514009	Hyundai	i20 05/10-12/14 (TR)	5½ J x14 H2	69,70
	HY 514010	Hyundai	i10 12/13-	5½ J x14 H2	63,50
	HY 515001	Hyundai	Trajet 05/00-12/07; Santa-Fe 01/01-02/06	6 J x15 CH	103,00
	HY 515012	Hyundai	i30 08/07-02/12 (ROK)	5½ J x15 CH	72,40
	HY 515013	Hyundai	i20 01/09-12/14 (IND)	5½ J x15 H2	72,40
	HY 515016	Hyundai	i20 05/10-12/14 (TR)	6 J x15 H2	72,90
	HY 515017	Hyundai	ix20 10/10-	6 J x15 H2	72,90
	HY 515018	Hyundai	i30 03/12-	6 J x15 CH	72,90
	HY 515018	Kia	Cee'd 06/12-	6 J x15 CH	72,90
	HY 515020	Hyundai	i20 II 01/15-	6 J x15 CH	72,90
	HY 516007	Hyundai	i30 08/07-02/12 (CZ)	6 J x16 H2	83,50
	HY 516009	Hyundai	ix35 03/10-08/13 (Sonderrad mit ABE); Tucson 09/15- (Sonderrad mit ABE)	6½ J x16 H2	86,10

Mit * gekennzeichnete Räder sind nur noch im Rahmen verfügbarer Lagerbestände lieferbar. | R = Renner

	Artikelnummer	Fahrzeughersteller	Fahrzeugmodell/Baujahr	Rädergröße	KB-Preis in €
	HY 516010	Hyundai	i40 09/11-	7 Jx16 H2	86,10
	HY 516011	Hyundai	i30 03/12- (Sonderrad)	6½ Jx16 CH	84,00
	HY 516011	Kia	Cee´d 06/12-	6½ Jx16 CH	84,00
	HY 516012	Hyundai	ix35 09/13- (Facelift)	6½ Jx16 H2	86,10
	HY 517001	Hyundai	Santa-Fe 03/06-05/13 (Eintragungspflichtiges Sonderrad)	7 Jx17 H2	117,30
	HY 616001	Hyundai	H1-Traveller 11/07-	6½ Jx16 CH	105,10
	HY 616001	Hyundai Lkw	H1-Cargo 06/08-	6½ Jx16 CH	105,10
Neu	HY 616002	Hyundai	H350 06/15-	6½ Jx16 H2	105,10
	IV 616011	Iveco	Daily S2000 (S2,S3 / 35C, 50C) 07/99-	5 JK x16 H	99,40
	IV 616012	Iveco	Daily S2000 (S2 / 35C) 07/99-	5½ Jx16 H2	99,40
	IV 616013	Iveco	Daily S2000 03/07-	6½ Jx16 H2	105,10
	IV 616014	Iveco	Daily S2000 (S4 / 65C) 07/99-; Eurocargo 01/02-	6 Jx16 H2	105,10
	KI 513003	Hyundai	i10 03/08-11/13	4.00 B x13 H2	62,90
	KI 513003	Kia	Picanto 04/04-12/07; Picanto 01/08-02/11; Picanto 03/11-	4.00 B x13 H2	62,90
	KI 514004	Hyundai	i10 03/08-11/13	5 Jx14 H2	71,90
	KI 514004	Kia	Picanto 04/04-12/07; Picanto 01/08-02/11	5 Jx14 H2	71,90
	KI 514005	Kia	Rio 08/05-08/11	5½ Jx14 H2	72,90
	KI 514006	Kia	Picanto 03/11-	5 Jx14 H2	71,90
*	KI 515003	Kia	Carens 08/02-09/06	6 JJ x15 H2	91,80
	KI 515006	Hyundai	i30 11/09-02/12 (CZ)	5½ Jx15 CH	72,40
	KI 515006	Kia	Cee´d 02/07-10/09; Cee´d 11/09-05/12	5½ Jx15 CH	72,40
	KI 515007	Kia	Carens 10/06-02/13	6 Jx15 H2	89,80
	KI 515008	Kia	Soul 02/09-02/14	6 Jx15 H2	75,50
	KI 515009	Kia	Venga 03/10-	6 Jx15 H2	72,90
	KI 515010	Kia	Rio 09/11-	5½ Jx15 H2	75,50
	KI 516002	Kia	Carnival 06/06-	6½ Jx16 H2	102,50
	KI 516003	Hyundai	i30 08/07-02/12 (ROK)	6 Jx16 CH	83,50
	KI 516003	Kia	Cee´d 02/07-05/12	6 Jx16 CH	83,50
	KI 516004	Kia	Sportage 09/10-02/14 (Sonderrad mit ABE)	6½ Jx16 H2	86,10
	KI 516006	Kia	Carens 03/13-	6½ Jx16 H2	86,10
	KI 516007	Kia	Soul 03/14-	6½ Jx16 H2	86,10
	KI 516008	Kia	Sportage 03/14-05/16 (Facelift)	6½ Jx16 CH	86,10
	MA 514009	Mazda	Mazda 2 10/07-01/15	6 Jx14 H2	68,70

Mit * gekennzeichnete Räder sind nur noch im Rahmen verfügbarer Lagerbestände lieferbar. | R = Renner

	Artikelnummer	Fahrzeughersteller	Fahrzeugmodell/Baujahr	Rädergröße	KB-Preis in €
	MA 515006	Mazda	Mazda 6 06/02-01/08	6 JJ x15 H2	78,70
	MA 515009	Mazda	Mazda 3 09/03-03/09; Mazda 5 08/05-08/10; Mazda 5 09/10-	6 J x15 H2	75,50
	MA 515011	Mazda	Mazda 2 10/07-01/15	6 J x15 H2	75,50
	MA 515012	Mazda	Mazda 3 04/09-09/13	6 J x15 H2	72,40
	MA 515014	Mazda	Mazda 2 02/15-	5½ J x15 H2	72,40
	MA 516001	Mazda	Mazda 3 09/03-03/09	6½ J x16 H2	83,50
	MA 516003	Mazda	MX-5 10/05-08/15	6½ J x16 H2	83,50
	MA 516004	Mazda	Mazda 6 02/08-01/13	6 J x16 H2	84,00
	MA 516006	Mazda	Mazda 6 02/13-	6½ J x16 H2	84,50
	MA 516007	Mazda	CX-3; Mazda 3 10/13-	6½ J x16 H2	82,40
	MA 517001	Mazda	CX-5 04/12-	7 J x17 H2	107,80
	MC 514001	MCC / smart	Smart ForFour 04/04-07/06	5½ J x14 H2	66,00
	MC 514001	Mitsubishi	Colt 05/04-03/13	5½ J x14 H2	66,00
	MC 515001	MCC / smart	Smart City Coupé 10/98-01/04; Smart ForTwo 02/04-03/07; Nur für die Vorderachse zulässig	3½ J x15 H	64,30
	MC 515002	MCC / smart	Smart City Coupé 10/98-01/04; Smart ForTwo 02/04-03/07; Nur für die Hinterachse zulässig	5½ J x15 H2	63,90
	MC 515003	MCC / smart	Smart City Coupé 01/00-01/04; Smart ForTwo 02/04-03/07; Nur für die Vorderachse zulässig	4 J x15 H2	62,90
	MC 515005	MCC / smart	Smart ForFour 04/04-07/06	6 J x15 H2	79,20
	MC 515005	Mitsubishi	Colt 05/04-03/13	6 J x15 H2	79,20
	MC 515006	MCC / smart	Smart ForTwo 04/07-10/14; Nur für die Vorderachse zulässig	4½ J x15 H2	62,90
	MC 515007	MCC / smart	Smart ForTwo 04/07-10/14; Nur für die Hinterachse zulässig	5½ J x15 H2	63,90
	MC 515008	MCC / smart	Smart ForFour II 11/14-; Smart ForTwo II 11/14-; Nur für die Vorderachse zulässig	5 J x15 H2	68,90
	MC 515009	MCC / smart	Smart ForFour II 11/14-; Smart ForTwo II 11/14-; Nur für die Hinterachse zulässig	5½ J x15 H2	69,90
	ME 515013	Mercedes-Benz	C-Klasse -03/04; C-Klasse 04/04-02/07; E-Klasse Limousine 06/95-02/02; CLK 06/97-04/09	6½ J x15 H2	67,60
	ME 515036	Mercedes-Benz	A-Klasse 10/97-08/04	5½ J x15 H2	62,90
R	ME 515049	Mercedes-Benz	A-Klasse 09/04-09/12; B-Klasse 06/05-09/11	6 J x15 H2	65,50
R	ME 515052	Mercedes-Benz	A-Klasse 10/12-; B-Klasse 10/11-; CLA 04/13-; Serienrad mit Flow-Form-Felge	6½ J x15 H2	65,50

Mit * gekennzeichnete Räder sind nur noch im Rahmen verfügbarer Lagerbestände lieferbar. | R = Renner

	Artikel-nummer	Fahrzeughersteller	Fahrzeugmodell/Baujahr	Rädergröße	KB-Preis in €
	* ME 516012	Mercedes-Benz	E-Klasse (W211) 03/02-03/09	7½ J x16 H2	88,70
	R ME 516017	Mercedes-Benz	A-Klasse 09/04-09/12; B-Klasse 06/05-09/11	6 J x16 H2	76,60
	ME 516022	Mercedes-Benz	C-Klasse 03/07-02/14 (nur C180K, C200 CDI); C-Coupé 03/11- (nur C180)	6 J x16 H2	76,60
	R ME 516024	Mercedes-Benz	C-Klasse 03/07-02/14; C-Coupé 03/11-	7 J x16 H2	80,30
	R ME 516025	Mercedes-Benz	A-Klasse 10/12-; B-Klasse 10/11-; CLA 04/13-; Serienrad mit Flow-Form-Felge	6½ J x16 H2	76,60
	ME 516026	Mercedes-Benz	C-Klasse 03/14- (nur C180)	6 J x16 H2	76,60
	ME 516027	Mercedes-Benz	V-Klasse 05/14-; Vito III 10/14-	6½ J x16 H2	98,80
	ME 517006	Mercedes-Benz	GLA 03/14-; Serienrad mit Flow-Form-Felge	6½ J x17 H2	95,70
	ME 517007	Mercedes-Benz	V-Klasse 05/14-; Vito III 10/14-	6½ J x17 H2	109,00
	ME 615014	Mercedes-Benz Lkw	Sprinter (Zwilling) 07/95-04/06	5½ J x15 H2	112,00
	ME 615014	VW Lkw	LT 08/96-04/06	5½ J x15 H2	112,00
	ME 615016	Mercedes-Benz Lkw	Sprinter 308/312/314 01/00-04/06	6 J x15 H2	84,50
	ME 615016	VW Lkw	LT 01/00-04/06	6 J x15 H2	84,50
	ME 616013	Mercedes-Benz Lkw	Sprinter NCV3 05/06- (Singlebereifung); Serie bei 3,5t zGG	6½ J x16 H2	92,40
	ME 616013	VW Lkw	Crafter 06/06-; Serie bei 3,5t zGG	6½ J x16 H2	92,40
	ME 616016	Mercedes-Benz Lkw	Viano 09/03-04/14; Vito II 09/03-09/14	6 J x16 H2	92,40
	ME 616017	Mercedes-Benz Lkw	Viano 09/03-04/14; Vito II 09/03-09/14	6½ J x16 H2	98,80
	ME 616036	Mercedes-Benz Lkw	Sprinter NCV3 06/06- (Zwillingsbereifung); Ersetzt ME 616022. Serie bei 5,0t zGG.	5½ J x16 H2	142,80
Neu	ME 616037	Mercedes-Benz	Sprinter NCV3 06/06- (Singlebereifung); Serie bei 3,0t zGG	5½ J x16 H2	92,40
Neu	ME 616037	VW Lkw	Crafter 06/06- (Singlebereifung); Serie bei 3,0t zGG	5½ J x16 H2	92,40
	MT 514013	Mitsubishi	Space Star 04/13-	4½ J x14 H2	58,70
	MT 516003	Mitsubishi	Outlander II 02/07-08/12	6½ JJ x16 CH	90,90
	MT 516003	Peugeot	4007 09/07-05/12	6½ JJ x16 CH	90,90
	MT 516004	Mitsubishi	Lancer 02/08-	6½ JJ x16 CH	86,10
	MT 516005	Mitsubishi	ASX 07/10-	6½ J x16 H2	90,90
	NI 514012	Nissan	Micra 04/03-02/11	5 J x14 H2	62,30
	NI 514013	Nissan	Micra 03/11-	5½ J x14 H2	62,90
	* NI 515005	Nissan	Almera Tino 09/00-02/06	6 J x15 CH	79,80
	NI 515007	Nissan	Micra 04/03-02/11; Micra 03/11-	5½ J x15 H2	72,40
	NI 515008	Nissan	Note 03/06-09/13	5½ J x15 H2	72,40

Mit * gekennzeichnete Räder sind nur noch im Rahmen verfügbarer Lagerbestände lieferbar. | R = Renner

	Artikelnummer	Fahrzeughersteller	Fahrzeugmodell/Baujahr	Rädergröße	KB-Preis in €
*	NI 515009	Nissan	Tiida 01/08-03/11	5½ J x15 CH	72,40
	NI 515010	Nissan	Note II 10/13-	5½ J x15 H2	72,40
*	NI 516001	Nissan	Primera 03/02-01/07	6½ J x16 CH	85,60
	NI 516003	Nissan	Qashqai 02/07-01/14	6½ J x16 CH	85,60
*	NI 516004	Nissan	Juke 10/10-	6½ J x16 CH	85,60
	NI 516005	Nissan	Juke 10/10-; Pulsar 10/14-; Qashqai II 02/14-	6½ J x16 CH	85,60
	NI 516005	Renault	Kadjar 07/15-	6½ J x16 CH	85,60
*	NI 614001	Nissan	Evalia 05/11-10/14	5½ J x14 CH	67,60
*	NI 614001	Nissan Lkw	NV 200 11/09-10/14	5½ J x14 CH	67,60
	NI 614002	Nissan	Evalia 11/14-; Ersetzt NI 614001	5½ J x14 CH	67,60
	NI 614002	Nissan Lkw	NV 200 11/14-; Ersetzt NI 614001	5½ J x14 CH	67,60
	OP 513013	Opel	Corsa-C 10/00-08/06	5 J x13 H2	46,50
*	OP 514002	Opel	Corsa-B -05/97; Tigra -12/00; Astra-F 09/92-05/00; Calibra 09/92-05/97; Vectra-A 09/92-09/95	5½ J x14 H2	55,00
	OP 514018	Opel	Corsa-C 10/00-08/06	5½ J x14 H2	55,00
*	OP 514020	Opel	Meriva-A 03/03-04/10 (4-Loch)	5½ J x14 H2	56,20
R	OP 514021	Opel	Adam 02/13-; Corsa-D 09/06-12/14; Corsa-E 01/15-	5½ J x14 H2	51,30
Neu	OP 514022	Opel	Karl 06/15-	5 J x14 H2	57,50
*	OP 515008	Opel	Astra (T98) 03/98-02/04; Vectra (J96) 10/95-12/98	6 J x15 H2	68,70
	OP 515016	Opel	Astra (T98) 03/98-02/04; Corsa-C 1,7 CDTI; Combo-C 1,7 CDTI 11/01-03/12; Vectra (J96)	6 J x15 H2	68,70
	OP 515017	Opel	Meriva-A 1,7 CDTI 10/03-04/10; Zafira 03/99-06/05	6 J x15 H2	66,60
	OP 515021	Opel	Meriva-A 03/03-04/10 (4-Loch); Tigra TwinTop 09/04-12/09	6 J x15 H2	65,00
	OP 515022	Opel	Astra -H 03/04-10/09; Tigra TwinTop 09/04-12/09	6½ J x15 H2	68,70
R	OP 515024	Opel	Adam 02/13-; Corsa-D 09/06-12/14; Corsa-E 01/15-	6 J x15 H2	66,00
R	OP 515027	Opel	Astra-H 03/04-10/09 (5-Loch); Vectra 04/02-10/08; Signum 05/03-06/08; Meriva-B 05/10-; Zafira-B 07/05-01/08; Zafira-B 02/08-09/11	6½ J x15 H2	68,20
Neu	OP 515029	Opel	Astra-K 10/15-	6 J x15 H2	66,00
R	OP 516007	Opel	Astra -H 03/04-10/09 (5-Loch); Astra -H Caravan 09/04-10/09 (5-Loch); Meriva-B 05/10-; Zafira-B 07/05-01/08; Zafira-B 02/08-09/11	6½ J x16 H2	81,40
	OP 516009	Opel	Corsa-D 09/06-12/14; Corsa-E 01/15-	6 J x16 H2	78,20
	OP 516010	Opel	Corsa-D 09/06-12/14	6 J x16 H2	78,20
	OP 516011	Chevrolet	Captiva 09/06-	6½ J x16 H2	108,30

Mit * gekennzeichnete Räder sind nur noch im Rahmen verfügbarer Lagerbestände lieferbar. | R = Renner

	Artikel- nummer	Fahrzeughersteller	Fahrzeugmodell/Baujahr	Rädergröße	KB-Preis in €
	OP 516011	Opel	Antara 09/06-	6½ Jx16 H2	108,30
R	OP 516012	Opel	Insignia 11/08-	6½ Jx16 H2	81,40
R	OP 516013	Chevrolet	Cruze 03/09- (5x105)	6½ Jx16 H2	81,40
R	OP 516013	Opel	Astra-J 11/09-09/15 (5x105)	6½ Jx16 H2	81,40
R	OP 516014	Chevrolet	Cruze 03/09- (5x115); Orlando 03/11-	6½ Jx16 H2	81,40
R	OP 516014	Opel	Ampera 01/12-; Astra-J 11/09-09/15 (5x115); Zafira Tourer 10/11-	6½ Jx16 H2	81,40
	OP 516015	Chevrolet	Trax 04/13-	6½ Jx16 H2	81,90
	OP 516015	Opel	Mokka 11/12-	6½ Jx16 H2	81,90
Neu	OP 516017	Opel	Astra-K 10/15-	6½ Jx16 H2	78,20
R	OP 517003	Opel	Insignia 11/08-; Ersetzt OP 517002	7 Jx17 H2	93,70
R	OP 517003	Saab	9-5 07/10-12/11; Ersetzt OP 517002	7 Jx17 H2	93,70
	OP 614001	Opel Lkw	Combo-C 11/01-03/12	5½ Jx14 H2	62,50
	OP 615001	Opel Lkw	Combo-C 11/01-03/12 (erhöhte Radlast)	6 Jx15 H2	73,40
	PS 514021	Peugeot	206 10/98-03/09; 206+ 04/09-12/12	5½ Jx14 CH	54,40
	PS 514022	Citroën	C2 11/03-12/09; C3 04/02-10/09	5½ Jx14 H2	54,40
	PS 514022	Peugeot	1007 04/05-12/09; 206+ 04/09-12/12	5½ Jx14 H2	54,40
	PS 515022	Citroën	Xsara 09/97-09/04; Xsara 11/00-09/04; Xsara Picasso 02/00-09/06	6 Jx15 H2	67,10
	PS 515022	Peugeot	406 10/95-04/04	6 Jx15 H2	67,10
	PS 515037	Citroën	C2 11/03-12/09; C3 04/02-10/09; C3 Pluriel 06/03-03/13; C4 11/04-01/09; C4 02/09-	6 Jx15 H2	67,10
	PS 515037	Peugeot	206 08/00-03/09; 206 SW 06/02-05/07; 206 CC 10/00-02/07; 206+ 04/09-12/12; 307 06/01-09/07; 1007 09/05-12/09	6 Jx15 H2	67,10
	PS 515039	Citroën	Xsara Picasso 02/00-09/06; Berlingo 09/96-04/08; Berlingo First 05/08-	6 Jx15 CH	67,10
	PS 515039	Peugeot	Partner 09/96-04/08; Partner Origin 05/08-	6 Jx15 CH	67,10
R	PS 515045	Citroën	C3 11/09-; DS3 03/10-; C3 Picasso 02/09-	6 Jx15 H2	67,10
R	PS 515045	Peugeot	207 06/06-03/12; 208 04/12-	6 Jx15 H2	67,10
	PS 515047	Citroën	C4 Picasso 10/06-05/13; Grand C4 Picasso 10/06-08/13	6½ Jx15 H2	66,40
	PS 515048	Citroën	C4 II 03/11-	6½ Jx15 H2	67,60
	PS 515048	Peugeot	308 10/07-08/13	6½ Jx15 H2	67,60
	PS 515049	Citroën	C-Zero 01/11-; Nur für die Vorderachse zulässig	4 Jx15 H2	82,90
	PS 515049	Mitsubishi	i-MiEV 01/11-; Nur für die Vorderachse zulässig	4 Jx15 H2	82,90
	PS 515049	Peugeot	iOn 01/11-; Nur für die Vorderachse zulässig	4 Jx15 H2	82,90

Mit * gekennzeichnete Räder sind nur noch im Rahmen verfügbarer Lagerbestände lieferbar. | R = Renner

	Artikelnummer	Fahrzeughersteller	Fahrzeugmodell/Baujahr	Rädergröße	KB-Preis in €
	PS 515050	Citroën	C-Zero 01/11-; Nur für die Hinterachse zulässig	5 J x15 H2	82,90
	PS 515050	Mitsubishi	i-MiEV 01/11-; Nur für die Hinterachse zulässig	5 J x15 H2	82,90
	PS 515050	Peugeot	iOn 01/11-; Nur für die Hinterachse zulässig	5 J x15 H2	82,90
	PS 515052	Citroën	C4 Cactus 09/14-	6½ J x15 H2	71,90
	PS 515052	Peugeot	2008 06/13-	6½ J x15 H2	71,90
	PS 515053	Peugeot	308 09/13-	6½ J x15 H2	67,60
	PS 516003	Peugeot	307 06/01-09/07; 307 CC 11/03-12/08	6½ J x16 H2	78,20
	PS 516008	Peugeot	407 05/04-02/11	6½ J x16 H2	82,40
	PS 516011	Citroën	C4 11/04-02/11; C5 10/04-03/08 (nur Facelift)	6½ J x16 H2	78,20
	PS 516012	Citroën	C4 Picasso 10/06-05/13; Berlingo 05/08-; Grand C4 Picasso 10/06-08/13	6½ J x16 H2	77,10
	PS 516012	Peugeot	Partner 05/08-	6½ J x16 H2	77,10
	PS 516013	Peugeot	207 06/06-03/12	6 J x16 H2	77,10
	PS 516014	Citroën	C5 04/08-	7 J x16 H2	79,20
	PS 516015	Peugeot	308 10/07-08/13; 308 CC 04/09-; 3008 06/09-	7 J x16 H2	79,20
	PS 516016	Citroën	C4 II 03/11-; DS4 05/11-	7 J x16 H2	78,20
	PS 516017	Peugeot	5008 10/09-	7 J x16 H2	77,10
	PS 516018	Citroën	C3 Picasso 02/09-	6 J x16 H2	76,60
	PS 516019	Peugeot	508 03/11-	7 J x16 H2	79,20
	PS 516020	Citroën	C4-Aircross 06/12-	6½ J x16 CH	90,90
	PS 516020	Mitsubishi	Outlander III 09/12-	6½ J x16 CH	90,90
	PS 516020	Peugeot	4008 06/12-	6½ J x16 CH	90,90
	PS 516021	Citroën	C4 Cactus 09/14-	6½ J x16 H2	77,10
	PS 516021	Peugeot	2008 06/13-	6½ J x16 H2	77,10
	PS 516022	Citroën	C4 Picasso 06/13-; Grand C4 Picasso 09/13-	6½ J x16 H2	77,10
	PS 516023	Peugeot	308 09/13-	7 J x16 H2	79,20
	PS 517001	Peugeot	407 05/04-02/11	7 J x17 H2	98,30
	PS 517002	Citroën	C5 04/08-; C6 11/05-12/12	7 J x17 H2	98,30
	PS 614002	Citroën	Berlingo 09/96-04/08; Berlingo First 05/08-	5½ J x14 CH	60,20
	PS 614002	Peugeot	Partner 09/96-04/08; Partner Origin 05/08-	5½ J x14 CH	60,20
	PS 615002	Citroën	Jumpy	6½ J x15 H2	84,50
	PS 615002	Fiat	Scudo 10/06-	6½ J x15 H2	84,50
	PS 615002	Peugeot	Expert 10/06-	6½ J x15 H2	84,50

Mit * gekennzeichnete Räder sind nur noch im Rahmen verfügbarer Lagerbestände lieferbar. | R = Renner

	Artikelnummer	Fahrzeughersteller	Fahrzeugmodell/Baujahr	Rädergröße	KB-Preis in €
	PS 615003	Citroën	Berlingo 05/08-	6½ J x15 H2	76,10
	PS 615003	Peugeot	Partner 05/08-	6½ J x15 H2	76,10
	PS 616001	Citroën	Jumpy	7 J x16 H2	90,90
	PS 616001	Fiat	Scudo 10/06-	7 J x16 H2	90,90
	PS 616001	Peugeot	Expert 10/06-	7 J x16 H2	90,90
	RE 514009	Renault	Twingo 07/00-08/07; Clio II 09/98-08/05; Mégane 01/96-09/02; Kangoo 05/98-12/07 (1.000 kg Achslast)	5½ J x14 CH	60,20
	RE 514018	Dacia	Logan 06/05-07/10; Logan MCV 01/07-07/13; Sandero 06/08-12/12	5½ J x14 H2	60,20
	RE 514019	Mercedes-Benz	Citan 09/12-	5½ J x14 H2	64,50
	RE 514019	Renault	Kangoo 01/08-	5½ J x14 H2	64,50
	RE 514020	Renault	Twingo II 09/07-08/14	5½ J x14 H2	60,20
	RE 515015	Renault	Clio II Sport 2.0 16V 06/00-08/05; Mégane 02/97-09/02; Scénic -06/03	6 J x15 H2	71,30
	RE 515019	Renault	Mégane II 10/02-10/08; Mégane II CC 10/02-06/10; Scénic II 07/03-05/09	6½ J x15 H2	70,80
	RE 515020	Renault	Clio III 09/05-09/12; Modus 09/04-12/12; Grand Modus 01/08-	5½ J x15 H2	72,40
R	RE 515021	Dacia	Logan 06/05-07/10; Logan MCV 01/07-07/13; Sandero 06/08-12/12; Stepway 09/09-12/12	6 J x15 H2	74,50
R	RE 515021	Renault	Clio III 09/05-09/12; Modus 09/04-12/12; Grand Modus 01/08-	6 J x15 H2	74,50
	RE 515023	Mercedes-Benz	Citan 09/12-	6 J x15 H2	75,00
	RE 515023	Renault	Kangoo 01/08-	6 J x15 H2	75,00
	RE 515026	Renault	Mégane III 11/08-12/15; Mégane III CC 07/10-12/15; Fluence 03/10-10/12; Scénic 06/09-05/16	6½ J x15 H2	70,80
R	RE 515027	Dacia	Sandero II 01/13-; Stepway II 01/13-	6 J x15 H2	74,50
R	RE 515027	Renault	Clio IV 10/12-	6 J x15 H2	74,50
	RE 515029	Dacia	Dokker 03/13-; Lodgy 06/12-	6 J x15 H2	71,50
	RE 515031	Dacia	Logan MCV 08/13-	6 J x15 H2	71,50
	RE 515032	Renault	Twingo III 09/14-; Nur für die Vorderachse zulässig	5 J x15 H2	68,90
	RE 515033	Renault	Twingo III 09/14-; Nur für die Hinterachse zulässig	5½ J x15 H2	69,90
Neu	RE 515035	Renault	Mégane IV 01/16-	6 J x15 H2	70,80
	RE 516009	Renault	Maguna II 03/01-09/07	6½ J x16 H2	78,20
	RE 516010	Renault	Mégane II 10/02-10/08; Mégane II CC 10/02-06/10; Scénic II 07/03-05/09	6½ J x16 H2	78,20

Mit * gekennzeichnete Räder sind nur noch im Rahmen verfügbarer Lagerbestände lieferbar. | R = Renner

	Artikelnummer	Fahrzeughersteller	Fahrzeugmodell/Baujahr	Rädergröße	KB-Preis in €
	RE 516013	Renault	Mégane III 11/08-12/15; Mégane III CC 07/10-12/15; Fluence 03/10-10/12; Fluence Z.E. 03/11-; Scénic 06/09-05/16; Grand Scénic 06/09-05/16	6½ Jx16 H2	78,20
	RE 516015	Renault	Laguna III 10/07-11/15; Latitude 12/10-10/12	7 J x16 H2	78,20
	RE 516018	Dacia	Duster 04/10-	6½ Jx16 H2	79,80
	RE 516020	Renault	Captur 06/13-	6½ Jx16 H2	78,20
Neu	RE 516021	Renault	Talisman 12/15-; Mégane IV 01/16-	6½ Jx16 H2	78,20
Neu	RE 517005	Renault	Espace V 04/15-	7 J x17 H2	98,30
	RE 615005	Nissan Lkw	Cabster 05/07-	5 J x15 H2	89,00
	RE 615005	Renault Lkw	Maxity 05/07-	5 J x15 H2	89,00
	RE 616003	Nissan Lkw	Interstar 09/02-	6 J x16 H2	90,90
	RE 616003	Opel Lkw	Movano 08/00-03/10	6 J x16 H2	90,90
	RE 616003	Renault Lkw	Master 08/00-03/10	6 J x16 H2	90,90
	RE 616008	Nissan Lkw	Primastar 06/02-11/14	6 J x16 H2	87,70
	RE 616008	Opel Lkw	Vivaro 07/01-11/14	6 J x16 H2	87,70
	RE 616008	Renault Lkw	Trafic 07/01-11/14	6 J x16 H2	87,70
	RE 616012	Opel Lkw	Movano 04/10-; Singlebereifung/Frontantrieb	6½ J x16 H2	87,70
	RE 616012	Renault Lkw	Master 04/10-; Singlebereifung/Frontantrieb	6½ J x16 H2	87,70
	RE 616013	Opel Lkw	Movano 04/10-; Singlebereifung/Frontantrieb	7 J x16 H2	88,20
	RE 616013	Renault Lkw	Master 04/10-; Singlebereifung/Frontantrieb	7 J x16 H2	88,20
	RE 616015	Opel Lkw	Movano 04/10-; Zwillingbereifung	5½ J x16 H2	118,60
	RE 616015	Renault Lkw	Master 04/10-; Zwillingbereifung	5½ J x16 H2	118,60
	RE 616016	Nissan	Primastar 12/14-	6 J x16 H2	87,70
	RE 616016	Opel	Vivaro 12/14-	6 J x16 H2	87,70
	RE 616016	Renault	Trafic 12/14-	6 J x16 H2	87,70
*	SA 515001	Saab	900 09/96-02/98; 9-3 03/98-08/02; 9-5 09/97-06/10	6 J x15 H2	74,50
	SA 516002	Opel	Vectra 04/02-10/08; Signum 05/03-06/08	6½ Jx16 H2	81,40
	SA 516002	Saab	9-3 09/02-12/11	6½ Jx16 H2	81,40
*	SB 515004	Subaru	Impreza 09/07-07/12	6 JJx15 CH	81,60
	SB 515005	Subaru	Impreza 08/12-	6 J x15 CH	79,50
	SB 516004	Subaru	Legacy 11/09-12/14; Forester 03/08-	6½ JJ x16 CH	97,70
	SU 514005	Opel	Agila 10/03-04/08	4½ Jx14 CH	57,50
	SU 514005	Subaru	G3X Justy 09/03-02/11	4½ Jx14 CH	57,50

Mit * gekennzeichnete Räder sind nur noch im Rahmen verfügbarer Lagerbestände lieferbar. | R = Renner

	Artikelnummer	Fahrzeughersteller	Fahrzeugmodell/Baujahr	Rädergröße	KB-Preis in €
	SU 514005	Suzuki	Ignis II 09/03-12/07; Wagon R+ 09/03-04/08	4½ J x14 CH	57,50
	SU 514006	Opel	Agila 04/08-	5 J x14 CH	59,70
	SU 514006	Suzuki	Swift (YN2) 05/05-08/10; Splash 04/08-09/14	5 J x14 CH	59,70
	SU 514008	Nissan	Pixo 07/09-10/13	4½ J x14 CH	58,70
	SU 514008	Suzuki	Alto 04/09-09/14	4½ J x14 CH	58,70
Neu	SU 514010	Suzuki	Celerio 12/14-	5 J x14 H2	59,70
	SU 515002	Fiat	Sedici 04/06-08/14	6 J x15 H2	71,30
	SU 515002	Suzuki	SX4 06/06-11/13; SX4 Classic 12/13-06/15	6 J x15 H2	71,30
	SU 515003	Opel	Agila 04/08-	5½ J x15 CH	69,20
	SU 515003	Suzuki	Splash 04/08-09/14	5½ J x15 CH	69,20
	SU 515004	Suzuki	Swift 09/10-	5 J x15 H2	69,70
	SU 516004	Fiat	Sedici 04/06-08/14	6 J x16 CH	78,20
	SU 516004	Suzuki	SX4 06/06-11/13; SX4 Classic 12/13-06/15	6 J x16 CH	78,20
	SU 516006	Suzuki	Kizashi 10/10-	6½ J x16 H2	87,10
	SU 516007	Suzuki	SX4 II 12/13-	6 J x16 H2	78,20
Neu	SU 516008	Suzuki	Vitara 04/15-	6½ J x16 H2	79,50
	TO 514015	Toyota	Yaris 04/99-11/05; Yaris Verso 04/99-02/11	5½ J x14 H2	65,00
	TO 514017	Citroën	C1 07/05-06/14	4½ J x14 H2	58,10
	TO 514017	Peugeot	107 09/05-06/14	4½ J x14 H2	58,10
	TO 514017	Toyota	Aygo 07/05-06/14	4½ J x14 H2	58,10
	TO 514018	Toyota	Yaris 12/05-09/11	5 J x14 CH	65,00
	TO 514020	Toyota	Yaris 10/11-	5 J x14 H2	62,90
	TO 514021	Citroën	C1 07/14-	4½ J x14 H2	58,10
	TO 514021	Peugeot	108 07/14-	4½ J x14 H2	58,10
	TO 514021	Toyota	Aygo 07/14-	4½ J x14 H2	58,10
	TO 515009	Toyota	Corolla 01/02-02/07	6 J x15 H2	72,40
	TO 515010	Toyota	Corolla 01/02-02/07; Corolla Verso 01/02-06/04	6 JJ x15 H2	72,40
	TO 515011	Daihatsu	Charade 05/11-01/13	5½ J x15 CH	72,40
	TO 515011	Toyota	Yaris 12/05-09/11	5½ J x15 CH	72,40
	TO 515012	Toyota	Auris 03/07-12/12	6 J x15 H2	72,40
	TO 515013	Toyota	iQ 01/09-	5 J x15 H2	72,40
	TO 515014	Toyota	Auris II 01/13-	6 J x15 H2	73,50
	TO 515017	Subaru	Trezia 03/11-	5½ J x15 CH	77,50

Mit * gekennzeichnete Räder sind nur noch im Rahmen verfügbarer Lagerbestände lieferbar. | R = Renner

	Artikelnummer	Fahrzeughersteller	Fahrzeugmodell/Baujahr	Rädergröße	KB-Preis in €
	TO 515017	Toyota	Verso-S 03/11-	5½ J x15 CH	77,50
R	TO 515018	Toyota	Yaris 10/11-	5 J x15 H2	72,40
	TO 515019	Citroën	C1 07/14-	4½ J x15 H2	71,90
	TO 515019	Peugeot	108 07/14-	4½ J x15 H2	71,90
	TO 515019	Toyota	Aygo 07/14-	4½ J x15 H2	71,90
	TO 516003	Toyota	Avensis II 05/03-12/08	6½ J x16 CH	86,10
	TO 516005	Toyota	Corolla Verso 07/04-04/09	6½ J x16 H2	85,10
	TO 516006	Toyota	Avensis II 07/05-12/08 (nur 2,2D-4D 110 kW/ 2,2 D-Cat 130kW)	6½ J x16 CH	86,10
*	TO 516008	Toyota	Prius II 03/04-05/09; Prius III 06/09-10/14	6 J x16 H2	84,50
	TO 516009	Toyota	Auris 03/07-12/12	6½ J x16 H2	85,10
	TO 516010	Toyota	Avensis III 01/09-02/16; Prius+ 06/12-; Verso 05/09-	6½ J x16 CH	86,10
	TO 516012	Toyota	Auris II 01/13-; Corolla 06/14-	6½ J x16 H2	84,50
	TO 516014	Toyota	Prius III 11/14-; Ersetzt TO 516008	6 J x16 H2	84,50
*	TO 615003	Toyota	Hi-Ace 11/95-01/11 (4WD)	6 JJ x15 H2	139,90
	VO 513015	Seat	Arosa 04/97-05/05	5½ J x13 H2	50,20
	VO 513015	VW	Lupo 10/98-03/05; Polo 10/98-11/01	5½ J x13 H2	50,20
R	VO 514015	Seat	Cordoba 01/03-06/08; Ibiza 04/02-06/08; Ibiza 07/08-; Toledo 11/12-	5 J x14 H2	56,00
R	VO 514015	Skoda	Fabia I 01/00-04/07; Fabia II 05/07-10/14; Fabia III 11/14-; Fabia Praktik 06/03-04/07; Praktik 05/07-; Rapid 10/12-; Roomster 09/06-	5 J x14 H2	56,00
R	VO 514015	VW	Fox 04/05-04/11; Polo 11/01-05/09; Polo 06/09-	5 J x14 H2	56,00
	VO 514016	Seat	Ibiza 04/02-06/08; Cordoba 01/03-06/08	6 J x14 H2	58,10
	VO 514016	Skoda	Fabia I 01/00-04/07	6 J x14 H2	58,10
	VO 514016	VW	Fox 04/05-04/11; Polo 11/01-05/09	6 J x14 H2	58,10
	VO 514020	Skoda	Fabia II 05/07-10/14; Roomster 09/06-; Praktik 05/07-	6 J x14 H2	58,70
R	VO 514021	Seat	Mii 04/12-	5 J x14 H2	56,80
R	VO 514021	Skoda	Citigo 06/12-	5 J x14 H2	56,80
R	VO 514021	VW	Up 06/11-	5 J x14 H2	56,80
	VO 515011	Audi	A3 -04/03	6 J x15 H2	64,50
	VO 515011	Seat	Leon 12/99-08/05; Toledo 04/99-11/04	6 J x15 H2	64,50
	VO 515011	Skoda	Octavia I 04/97-05/04; Octavia I Combi 04/97-12/04; Octavia I "TOUR" (Typ: 1U) 06/04-06/10	6 J x15 H2	64,50
	VO 515011	VW	Golf IV 10/97-09/03; Bora; New Beetle -09/11; Polo Fun 01/04-04/05; Cross Polo 02/02-05/09	6 J x15 H2	64,50

Mit * gekennzeichnete Räder sind nur noch im Rahmen verfügbarer Lagerbestände lieferbar. | R = Renner

	Artikelnummer	Fahrzeughersteller	Fahrzeugmodell/Baujahr	Rädergröße	KB-Preis in €
	VO 515020	Seat	Ibiza 04/02-06/08; Cordoba 01/03-06/08	6 Jx15 H2	64,50
	VO 515020	VW	Fox 04/05-04/11; Polo 11/01-05/09	6 Jx15 H2	64,50
R	VO 515024	Seat	Leon 10/08-11/12; Altea 10/08-; Altea XL 10/08-	6 Jx15 H2	63,90
R	VO 515024	Skoda	Octavia II 06/04-01/13 (Typ: 1Z); Octavia II Combi 01/05-01/13 (Typ: 1Z)	6 Jx15 H2	63,90
R	VO 515024	VW	Golf V 10/03-09/08; Golf VI 10/08-10/12; Golf VI Cabrio 06/11-; Jetta 08/05-12/10; Jetta 01/11-; Touran 03/03-08/15; Cross Touran 05/09-	6 Jx15 H2	63,90
R	VO 515025	Skoda	Fabia I 01/00-04/07; Fabia II 05/07-10/14; Roomster 09/06-; Praktik 05/07-	6 Jx15 H2	64,50
R	VO 515030	Seat	Ibiza 07/08-; Toledo 11/12-	6 Jx15 H2	64,50
R	VO 515030	Skoda	Fabia III 11/14-; Rapid 10/12-	6 Jx15 H2	64,50
R	VO 515030	VW	Polo 06/09-	6 Jx15 H2	64,50
R	VO 515031	Seat	Leon 12/12-; Leon ST 12/13-; Serienrad mit Flow-Form-Felge	6 Jx15 H2	67,10
R	VO 515031	Skoda	Octavia III 02/13-; Serienrad mit Flow-Form-Felge	6 Jx15 H2	67,10
R	VO 515031	VW	Golf VII 11/12-; Golf Sportsvan 03/14-; Serienrad mit Flow-Form-Felge	6 Jx15 H2	67,10
	VO 516005	Audi	A3 -04/03	6½ Jx16 H2	82,40
	VO 516005	Seat	Leon 12/99-10/05; Toledo 04/99-11/04	6½ Jx16 H2	82,40
	VO 516005	Skoda	Fabia I 07/03-04/07; Octavia I 04/97-05/04; Octavia I Combi 04/97-12/04; Octavia I "TOUR" (Typ: 1U) 06/04-06/10	6½ Jx16 H2	82,40
	VO 516005	VW	Golf IV 10/97-09/03; Bora; New Beetle -09/11	6½ Jx16 H2	82,40
	VO 516010	Ford	Galaxy 07/01-05/06	6 Jx16 H2	79,70
	VO 516010	Seat	Alhambra I 07/01-09/10	6 Jx16 H2	79,70
	VO 516010	VW	Sharan I 07/01-07/10	6 Jx16 H2	79,70
R	VO 516015	Audi	A3 05/03-08/12; A3 Sportback 09/04-01/13	6½ Jx16 H2	75,00
R	VO 516015	Seat	Leon 09/05-11/12; Altea 06/04-; Toledo 12/04-10/12	6½ Jx16 H2	75,00
R	VO 516015	Skoda	Octavia II 06/04-01/13; Octavia II Combi 01/05-01/13	6½ Jx16 H2	75,00
R	VO 516015	VW	Golf V 10/03-09/08; Golf VI 10/08-10/12; Golf VI Cabrio 06/11-; Jetta 08/05-12/10; Jetta 01/11-; Touran 03/03-08/15	6½ Jx16 H2	75,00
R	VO 516025	VW	Eos 06/06-06/15; Scirocco 08/08-; Passat 03/05-09/10	6½ Jx16 H2	80,30
R	VO 516028	VW	Tiguan 12/07-11/15	6½ Jx16 H2	84,50
R	VO 516029	Seat	Exeo 03/09-	7 Jx16 H2	78,20
R	VO 516029	Skoda	Superb 07/08-04/15; Superb Combi 06/10-08/15; Yeti 10/09-	7 Jx16 H2	78,20
R	VO 516030	VW	Eos 06/06-06/15; Passat 03/05-09/10; Passat 10/10-10/14; Scirocco 08/08-; Serienrad mit Flow-Form-Felge	6½ Jx16 H2	80,30

Mit * gekennzeichnete Räder sind nur noch im Rahmen verfügbarer Lagerbestände lieferbar. | R = Renner

	Artikelnummer	Fahrzeughersteller	Fahrzeugmodell/Baujahr	Rädergröße	KB-Preis in €
R	VO 516031	Seat	Alhambra II 10/10-; Serienrad mit Flow-Form-Felge	6½ Jx16 H2	84,50
R	VO 516031	VW	Sharan II 08/10-; Serienrad mit Flow-Form-Felge	6½ Jx16 H2	84,50
R	VO 516033	VW	Beetle II 10/11-	6½ Jx16 H2	82,90
R	VO 516034	Audi	A3 09/12- (Schrägheck/Sportback); Serienrad mit Flow-Form-Felge	6 Jx16 H2	78,20
R	VO 516034	Seat	Leon 12/12-; Leon ST 12/13-; Serienrad mit Flow-Form-Felge	6 Jx16 H2	78,20
R	VO 516034	Skoda	Octavia III 02/13-; Serienrad mit Flow-Form-Felge	6 Jx16 H2	78,20
R	VO 516034	VW	Golf VII 11/12-; Golf Sportsvan 03/14-; Serienrad mit Flow-Form-Felge	6 Jx16 H2	78,20
R	VO 516035	Audi	A3 09/12- (Schrägheck/Sportback); Serienrad mit Flow-Form-Felge	6½ Jx16 H2	78,50
R	VO 516035	Seat	Leon 12/12-; Leon ST 12/13-; Serienrad mit Flow-Form-Felge	6½ Jx16 H2	78,50
R	VO 516035	Skoda	Octavia III 02/13-; Serienrad mit Flow-Form-Felge	6½ Jx16 H2	78,50
R	VO 516035	VW	Golf VII 11/12-; Golf Sportsvan 03/14-; Serienrad mit Flow-Form-Felge	6½ Jx16 H2	78,50
	VO 516036	VW	Polo GTI 11/12-; Polo R 08/13-	6 Jx16 H2	74,50
R	VO 516037	Skoda	Superb 05/15-; Superb Combi 09/15-	6½ Jx16 H2	80,30
R	VO 516037	VW	Passat 11/14-	6½ Jx16 H2	80,30
Neu	VO 516038	VW	Touran 09/15-	6½ Jx16 H2	84,50
R	VO 615036	VW	Caddy 01/04-06/15; Caddy 07/15-; Caddy Life 06/04-; Caddy Maxi 01/08-; Caddy Maxi Life 11/07-	6 Jx15 H2	70,80
R	VO 616016	VW	Multivan/Shuttle/Transporter (T5) 05/03-09/09; Multivan/Shuttle/Transporter (T5) 10/09-07/15; Multivan/Shuttle/Transporter (T6) 08/15-	6½ Jx16 H2	86,10
	VO 616017	VW	T5 Maxi 05/04-09/09; T5 Maxi 10/09-07/15	6½ Jx16 H2	88,80
	VO 616021	VW	Caddy 10/07-06/15; Caddy 07/15-; Caddy Life 11/07-; Caddy Maxi 01/08-; Caddy Maxi Life 11/07-	6 Jx16 H2	79,80
	VO 616024	VW Lkw	Amarok 06/10-; T5 Rociton 12/10-07/15	6½ Jx16 H2	88,80
	VO 616025	VW Lkw	T5 Bluemotion 03/11-07/15	6½ Jx16 H2	86,10
	VO 617001	VW	Multivan/Shuttle/Transporter (T5) 05/03-09/09; Multivan/Shuttle/Transporter (T5) 10/09-07/15; Multivan/Shuttle/Transporter (T6) 08/15-	7 Jx17 H2	117,80
	VV 515017	Volvo	C30 12/06-12/12; S40 01/04-; V40 09/12-; V50 04/04-	6 Jx15 H2	83,50
	VV 516004	Volvo	C30 12/06-12/12; S40 01/04-; V40 09/12-; V50 04/04-; XC40 01/13-	6½ Jx16 H2	86,10
	VV 516005	Volvo	S60 II 09/10-; V60 11/10-; V70 08/07-; S80 05/06-; XC 70 09/07-	7 Jx16 H2	91,40



Mit * gekennzeichnete Räder sind nur noch im Rahmen verfügbarer Lagerbestände lieferbar. | R = Renner



		939	09/05-12/12	159	
	Stufenheck, Sportwagon	163390	8215	AR 516003	Stahl
	1,8 MPI 16V (110 kW)/ 1,9 JTS (118 kW)/	205/55R16		7 J x16 H2	
	1,9 JTDM 8V (88 kW)/ 1,9 JTDM 16V (110 kW)	215/55R16		5x110x65	
	2,2 JTS (136 kW)/ 1,9 JTDM 16V (125 kW)	215/55R16		ET 34	
		Kegel sw 17 M14 x 1,5 x 25		€ 91,80	
RDKS					

		03/16-	Giulia		
Radabbildung in Vorbereitung	Stufenheck, Sportwagon			INFO	Stahl
	INFO				
RDKS					



		Giulia			
Radabbildung in Vorbereitung					MAGMA
				in Vorbereitung	
RDKS					

		940	04/10-	Giulietta	
	Schrägheck	163393	8227	AR 516007	Stahl
	1,4 TB (88 kW)/ 1,4 TM MultiAir (125 kW)/ 1,6 JTDM (77 kW)/	205/55R16		7 J x16 H2	
	2,0 JTDM (125 kW)			5x110x65	
				ET 41	
		Kegel sw 17 M12 x 1,25 x 22		€ 87,70	
RDKS					

		940	Giulietta			
		lichtsilber-lackiert / mattschwarz-lackiert		Interio	IN 706 35 5 10	
		Bremsanlage beachten	TÜV	205/55R16 ❄	7 J x16 EH2+	
					5 x 110	
					ET 35	
MK 112		ASC; CUC; Huf 2.4; Huf 3.4; Huf 3.5; SE1C1; SE1S				
RDKS						



MiTo		07/08-	955			
Stahl	AR 516005	9442	163392	Schrägheck		
	7 J x16 H2	195/55R16		0,9i (63 kW)/ 1,4i-16V (70 kW)/ 1,4 TB-16V (114 kW)/		
	4x98x58			1,6 JTDM 16V (88 kW)		
	ET 39					
	€ 87,70	Kegel sw 17 M12 x 1,25 x 22				
RDKS	ASC; ASS; CUC; CUS; Huf 2.4; Huf 3.4; SE1C1; SE1C2; SE1S; TTC; TTS / OE: Schrader 3016					
MiTo		955				
MAGNA	Interio	IN 706 30 4 98	lichtsilber-lackiert / mattschwarz-lackiert			
	7 J x16 EH2+	195/55R16	TÜV	Auflagen beachten!		
	4 x 98					
	ET 30					
RDKS	ASC; CUC; Huf 2.4; Huf 3.4; Huf 3.5; SE1C1; SE1S			MK 110	IN	IN

AUDI

A1		09/10-	8X			
Renner	AD 515015	7415	155301	Schrägheck, Sportback		
	6 J x15 H2	185/60R15		1,0 TFSI (70 kW)/ 1,2 TFSI (63 kW)/ 1,4 TFSI (90/103 kW)/		
	5x100x57	185/60R15 M+S		1,4 TDI (66/85 kW)/ 1,6 TDI (66/77 kW)		
	ET 29	185/60R15 M+S		1,4 TFSI (92/110/136 kW)/ 2,0 TDI (105 kW)		
	€ 64,50	Kugel sw 17 M14 x 1,5 x 27		Nicht 1,8 TFSI (141 kW)		
RDKS	ASC; ASS; CUC; Huf 2.4; Huf 3.4; Huf 3.5; SE1C1; SE1C2; SE2C1; SE2C2; SE1S; SE2S					
A1 / A1 Sportback		8X				
MAGNA	Interio	IN 605 35 5 00	lichtsilber-lackiert / mattschwarz-lackiert			
	6 J x15 H2	185/60R15 M+S ❄	ABE			
	5 x 100	205/55R15	ABE			
	ET 35					
RDKS	ASC; ASS; CUS; Huf 2.4; Huf 3.4; SE1C1; SE1C2; SE1S; TTC; TTS			MK 303	IN	IN

		8X	09/10-			A1	
	Schrägheck, Sportback	155401				AD 515016	
	1,0 TFSI (70 kW) / 1,2 TFSI (63 kW) / 1,4 TFSI (90/103/136 kW) / 1,6 TDI (66/77 kW)	205/55R15				6½ J x15 H2 5x100x57 ET 34	
	Nicht 1,8 TFSI (141 kW)	Kugel sw 17 M14 x 1,5 x 27				€ 64,50	
		ASC; ASS; CUC; Huf 2.4; Huf 3.4; Huf 3.5; SE1C1; SE1C2; SE2C1; SE2C2; SE1S; SE2S					RDKS

Renner

		8X	A1 / A1 Sportback				
		lichtsilber-lackiert		Celsio	CS 655 35 5 00		
		lichtsilber-lackiert / mattschwarz-lackiert		Tezzo	TZ 655 35 5 00		
CS		ABE	185/60R15 M+S ❄			6½ J x15 H2	
		ABE	205/55R15M+S			5 x 100	
						ET 35	
MK 303		Celsio: ASC; ASS; CUC; Huf 2.4; Huf 3.4; Huf 3.5; SE1C1; SE1C2; SE1S; TTC; TTS Tezzo: ASC; ASS; CUC; Huf 2.4; Huf 3.4; Huf 3.5; SE1C1; SE1C2; SE1S; TTC					RDKS

MAGMA

		8L	09/96-04/03			A3
	Schrägheck	152503	8380			VO 515011
	1,6(75 kW) /1,8 (92 kW)/1,8T (110/132 kW) / 1,9TDI (66/81/96kW)	195/65R15				6 J x15 H2 5x100x57 ET 38
		Kugel sw 17 M14 x 1,5 x 27				€ 64,50
						RDKS

Stahl

		8L	09/96-04/03			A3
	Schrägheck	162701	9680			VO 516005
	1,6(75 kW) /1,8 (92 kW)/1,8T (110/132 kW) / 1,9TDI (66/81/96kW)	205/55R16				6½ J x16 H2 5x100x57 ET 42
		Kugel sw 17 M14 x 1,5 x 27				€ 82,40
						RDKS

Stahl



		8P	05/03-08/12			A3
	Schrägheck, Cabrio	164001	9535			AD 516012
	1,2 TFSI/ 1,4 TFSI/ 1,6i/ 1,6 FSI/ 1,8 TFSI/ 2,0 FSI/ 2,0 TFSI/ 1,6 TDI/ 1,9 TDI/ 2,0 TDI	205/55R16 M+S				6 J x16 H2 5x112x57 ET 50
		Kugel sw 17 M14 x 1,5 x 27				€ 74,50
						RDKS



Renner





A3			05/03-08/12	8P	
Renner	VO 516015	9915	163902	Schrägheck, Cabrio	
	6½ J x16 H2	205/55R16		1,2 TFSI/ 1,4 TFSI/ 1,6i/ 1,6 FSI/ 1,8 TFSI/ 2,0 FSI/ 2,0 TFSI/ 1,6 TDI/ 1,9 TDI/ 2,0 TDI	
	5x112x57				
	ET 50				
€ 75,00		Kugel sw 17 M14 x 1,5 x 27		Keine Schneeketten zulässig.	
RDKS					



A3 Sportback			09/04-08/12	8P	
Renner	AD 516012	9535	164001	Schrägheck	
	6 J x16 H2	205/55R16 M+S		1,2 TFSI/ 1,4 TFSI/ 1,6i/ 1,6 FSI/ 1,8 TFSI/ 2,0 FSI/ 2,0 TFSI/ 1,6 TDI/ 1,9 TDI/ 2,0 TDI	
	5x112x57				
	ET 50				
€ 74,50		Kugel sw 17 M14 x 1,5 x 27			
RDKS					



A3 Sportback			09/04-08/12	8P	
Renner	VO 516015	9915	163902	Schrägheck	
	6½ J x16 H2	205/55R16		1,2 TFSI/ 1,4 TFSI/ 1,6i/ 1,6 FSI/ 1,8 TFSI/ 2,0 FSI/ 2,0 TFSI/ 1,6 TDI/ 1,9 TDI/ 2,0 TDI	
	5x112x57				
	ET 50				
€ 75,00		Kugel sw 17 M14 x 1,5 x 27		Keine Schneeketten zulässig.	
RDKS					

A3 / A3 Sportback / Cabriolet				8P		
MAGNA	Celsio	CS 656 50 5 12	lichtsilber-lackiert			
	Tezzo	TZ 656 50 5 12	lichtsilber-lackiert / mattschwarz-lackiert			
	6½ J x16 H2	205/55R16	ABE			
	5 x 112	215/50R16	ABE			
	ET 50					
RDKS	Celsio: ASC; ASS; CUC; Huf 2.4; Huf 3.4; Huf 3.5; SE1C1; SE1C2; SE1S; TTC; TTS Tezzo: ASC; ASS; CUC; Huf 2.4; Huf 3.4; Huf 3.5; SE1C1; SE1C2; SE1S; TTC			MK 306	CS	TZ

A3 / A3 Sportback / Cabriolet				8P		
MAGNA	Interio	IN 706 45 5 12	lichtsilber-lackiert / mattschwarz-lackiert			
	7 J x16 EH2+	205/55R16 ❄	ABE			
	5 x 112					
	ET 45					
RDKS	ASC; CUC; Huf 2.4; Huf 3.4; Huf 3.5; SE1C1; SE1S			MK 306	IN	IN



		8P	A3 / A3 Sportback / Cabriolet			
	CS	lichtsilber-lackiert MK 306	Celsio		CS 707 45 5 12	KRONPRINZ MAGMA RDKS
			ABE	205/50R17	7 J x17 EH2+	
			ABE	215/45R17 ❄		
		ABE	225/45R17	ET 45		
		ASC; ASS; CUC; Huf 2.4; Huf 3.4; Huf 3.5; SE1C1; SE1C2; SE1S; TTC			RDKS	
		8V	09/12-			A3
	Schrägheck 1,2 TFSI (77/81 kW)/ 1,4 TFSI (90/92/103/110 kW)/ 1,8 TFSI (132 kW)/ 1,6 TDI (77/81 kW)/ 2,0 TDI (105/110/135 kW)	165601	8247	VO 516034	Renner RDKS	
		205/55R16 M+S		6 J x16 H2		
		Kugel sw 17 M14 x 1,5 x 27		5x112x57 ET 48 € 78,20		
		ASS; CUC; Huf 2.4; Huf 3.4; Huf 3.5; SE1C1; SE1C2; SE2C1; SE2C2; SE1S; SE2S			RDKS	
		8V	09/12-			A3
	Schrägheck 1,2 TFSI (77/81 kW)/ 1,4 TFSI (90/92/103/110 kW)/ 1,8 TFSI (132 kW)/ 1,6 TDI (77/81 kW)/ 2,0 TDI (105/110/135 kW)	165305	8667	VO 516035	Renner RDKS	
		205/55R16 M+S		6½ J x16 H2		
		205/55R16		5x112x57 ET 46 € 78,50		
		Kugel sw 17 M14 x 1,5 x 27			RDKS	
		ASC; ASS; CUC; Huf 2.4; Huf 3.4; Huf 3.5; SE1C1; SE1C2; SE2C1; SE2C2; SE1S; SE2S			RDKS	
		8V			A3 Cabrio	
	Cabrio 1,2 TFSI (77 kW)/ 1,4 TFSI (92 kW)/ 1,8 TFSI (118/132 kW)/ 1,6 TDI (77 kW)/ 2,0 TDI (110/135 kW)	163374	9187	AD 516016	Stahl RDKS	
		205/55R16 M+S		6½ J x16 H2		
		Kugel sw 17 M14 x 1,5 x 27		5x112x57 ET 43 € 78,50		
					RDKS	
		8V	06/13-			A3 Limousine
	Stufenheck 1,2 TFSI (77 kW)/ 1,4 TFSI (92/103/110)/ 1,8 TFSI (118/132 kW)/ 1,6 TDI (81 kW)/ 2,0 TDI (110/135 kW)	163374	9187	AD 516016	Stahl RDKS	
		205/55R16 M+S		6½ J x16 H2		
		Kugel sw 17 M14 x 1,5 x 27		5x112x57 ET 43 € 78,50		
					RDKS	



A3 Cabriolet / A3 Limousine			8V		
MAGNA	Tezzo TZ 656 50 5 12		lichtsilber-lackiert / mattschwarz-lackiert		
	6½ J x16 H2	205/55R16 M+S	ABE		
	5 X 112				
	ET 50				
RDKS	ASC; ASS; CUC; Huf 2.4; Huf 3.4; Huf 3.5; SE1C1; SE1C2; SE1S; TTC		MK 306	TZ	TZ



A3 Cabriolet / A3 Limousine			8V		
MAGNA	Tezzo TZ 757 35 5 12		lichtsilber-lackiert / mattschwarz-lackiert		
	7½ J x17 H2	205/45R17	ABE		
	5 X 112	215/45R17	ABE		
	ET 35	225/45R17	ABE		
RDKS	ASC; ASS; CUC; Huf 2.4; Huf 3.4; Huf 3.5; SE1C1; SE1C2; SE1S		MK 306	TZ	TZ



A3 Sportback		02/13-	8V		
Renner	VO 516034	8247	165601	Schrägheck	
	6 J x16 H2	205/55R16 M+S		1,2 TFSI (81 kW)/ 1,4 TFSI (90/92/110 kW)/ 1,8 TFSI (132 kW)/	
	5x112x57			1,6 TDI (81 kW)/ 2,0 TDI (105/110/135 kW)/ 1,4 g-tron (81 kW)	
	ET 48				
	€ 78,20	Kugel sw 17 M14 x 1,5 x 27			
RDKS	ASS; CUC; Huf 2.4; Huf 3.4; Huf 3.5; SE1C1; SE1C2; SE2C1; SE2C2; SE1S; SE2S				

A3 Sportback		02/13-	8V		
Renner	VO 516035	8667	165305	Schrägheck	
	6½ J x16 H2	205/55R16		1,2 TFSI (81 kW)/ 1,4 TFSI (90/92/110 kW)/ 1,8 TFSI (132 kW)/	
	5x112x57	205/55R16 M+S		1,6 TDI (81 kW)/ 2,0 TDI (105/110/135 kW)/ 1,4 g-tron (81 kW)	
	ET 46				
	€ 78,50	Kugel sw 17 M14 x 1,5 x 27			
RDKS	ASC; ASS; CUC; Huf 2.4; Huf 3.4; Huf 3.5; SE1C1; SE1C2; SE2C1; SE2C2; SE1S; SE2S				

A3 / A3 Sportback			8V		
MAGNA	Celsio CS 656 50 5 12		lichtsilber-lackiert		
	Tezzo TZ 656 50 5 12		lichtsilber-lackiert / mattschwarz-lackiert		
	6½ J x16 H2	205/55R16 *	ABE		
	5 x 112	215/50R16 *	ABE		
	ET 50				
RDKS	Celsio: ASC; ASS; CUC; Huf 2.4; Huf 3.4; Huf 3.5; SE1C1; SE1C2; SE1S; TTC; TTS Tezzo: ASC; ASS; CUC; Huf 2.4; Huf 3.4; Huf 3.5; SE1C1; SE1C2; SE1S; TTC		MK 306	CS	TZ

		8V	A3 / A3 Sportback		
		lichtsilber-lackiert / mattschwarz-lackiert		Interio	IN 706 45 5 12
			ABE	205/55R16	7 J x16 EH2+ 5 x 112 ET 45
	ABE	215/50R16 ❄			
IN	IN	MK 306	ASC; CUC; Huf 2.4; Huf 3.4; Huf 3.5; SE1C1; SE1S		RDKS

		8V	A3 / A3 Sportback / S3 / S3 Sportback		
		lichtsilber-lackiert / mattschwarz-lackiert		Tezzo	TZ 757 50 5 12
		S3 Modelle Bereifungen nur M*S und keine SKF	ABE	205/50R17	7½ J x17 H2 5 x 112 ET 50
	ABE	215/45R17 ❄			
	ABE	225/45R17			
TZ	TZ	MK 306	ASC; ASS; CUC; Huf 2.4; Huf 3.4; Huf 3.5; SE1C1; SE1C2; SE1S		RDKS

		8V	A3 / A3 Sportback / S3 / S3 Sportback		
		lichtsilber-lackiert / mattschwarz-lackiert		Interio	IN 807 50 5 12
		S3 Modelle Bereifungen nur M*S und keine SKF	ABE	205/50R17	8 J x17 EH2+ 5 x 112 ET 50
	ABE	215/45R17 ❄			
	ABE	225/45R17			
IN	IN	MK 306	ASC; CUC; Huf 3.5; SE1C1; SE1S		RDKS

		8E	12/00-10/04	A4	
	Stufenheck, Avant	163102	9885	AD 516011	Stahl
	1,6i (75 kW)/ 2,0/2,0FSI/1,9TDi	205/55R16		7 J x16 H2	
	2,4i/3,0i/2,5TDi (125/162/120 kW)	215/55R16		5x112x57 ET 42	
		Kugel sw 17 M14 x 1,5 x 27		€ 78,20	
				RDKS	



		8E	11/04-10/07	A4 (Facelift)	
	Stufenheck, Avant	163102	9885	AD 516011	Stahl
	1,6i (75 kW)/ 2,0i (96 kW)/ 1,8T (120 kW)/	205/55R16		7 J x16 H2	
	2,0 TFSI (125 kW)/ 1,9 TDI (85 kW)/	215/55R16		5x112x57 ET 42	
	2,0 TDI (103/125 kW)	Kugel sw 17 M14 x 1,5 x 27		€ 78,20	
	2,0 TFSI (147 kW)/ 3,2 FSI/ 2,5 TDI/ 2,7 TDI/ 3,0 TDI nur LM-Guss.			RDKS	

A4 / A4 Cabriolet			8E, 8H, QB6	
MAGNA	Celsio CS 706 38 5 12		lichtsilber-lackiert	
	7 J x16 EH2+	205/55R16 M+S ❄	ABE	
	5 x 112	215/55R16	ABE	
	ET 38			
RDKS	ASC; CUC; Huf 3.4; Huf 3.5; SE1C1; SE15		MK 306	CS

A4 / A4 Cabriolet / S4 / S4 Cabriolet			8E, 8H, QB6	
MAGNA	Celsio CS 807 35 5 12		lichtsilber-lackiert	
	Interio IN 807 35 5 12		lichtsilber-lackiert / mattschwarz-lackiert	
	8 J x17 EH2+	205/50R17	ABE	 
	5 x 112	225/45R17	ABE	
	ET 35			
S4 + Cabrio S4 Bereifung nur 225/45R17M+S				
RDKS	Celsio: ASC; ASS; CUC; Huf 2.4; Huf 3.4; Huf 3.5; SE1C1; SE15 Interio: ASC; CUC; Huf 3.5; SE1C1; SE15		MK 306	CS IN

A4		11/07-10/15	B8, B81	
Renner	AD 516014	9537	165201	Stufenheck, Avant
	7 J x16 H2	205/60R16		1,8 TFSI (88/118/125 kW)/
	5x112x66,5			2,0 TDI (88/100/105/110/120/125/130/140 kW)/
	ET 39			2,0 TDIe (100 kW)/ Quattro
RDKS	€ 77,70	Kugel sw 17 M14 x 1,5 x 27		Nicht A4 Allroad! Wenn Rad-/Reifenkombination nicht eingetragen, dann Sonderrad! Avant -06/15

A4		11/07-10/15	B8, B81	
Renner	AD 516014	9537	165201	Stufenheck, Avant
	7 J x16 H2	205/60R16		1,8 TFSI/ 2,0 TDI/ 2,0 TFSI/ 3,2 FSI/ 2,0 TDI/ 2,7 TDI/
	5x112x66,5	205/60R16 M+S		3,0 TDI/ Quattro/ (88-199 kW)
	ET 39	225/55R16		
RDKS	€ 77,70	Kugel sw 17 M14 x 1,5 x 27		Sonderrad mit ABE. Gutachten beachten. Nicht A4 Allroad! Avant -06/15 Achslast max. 1300 kg.

A4 / A4 Avant			B8, B81	
MAGNA	Interio IN 706 38 5 12		lichtsilber-lackiert / mattschwarz-lackiert	
	7 J x16 EH2+	205/60R16 ❄	ABE	 
	5 x 112	225/55R16 ❄	ABE	
	ET 38			
RDKS	ASC; CUC; Huf 2.4; Huf 3.4; Huf 3.5; SE1C1; SE15		MK 307	IN IN

		B8, B81	A4 / A4 Avant		
	TZ	lichtsilber-lackiert / mattschwarz-lackiert		Tezzo	TZ 756 42 5 12
			ABE	205/60R16 * 225/55R16	7½ J x16 H2 5 x 112 ET 42
			ABE	225/55R16	
MK 307		ASC; ASS; CUC; Huf 2.4; Huf 3.4; Huf 3.5; SE1C1; SE1C2; SE1S; TTC			RDKS

		B8, B81	A4 / A4 Avant		
	CS	lichtsilber-lackiert		Celsio	CS 707 45 5 12
			ABE	205/55R17 * 215/50R17 * 225/50R17 *	7 J x17 EH2+ 5 x 112 ET 45
			ABE	225/50R17 *	
MK 307		ASC; ASS; CUC; Huf 2.4; Huf 3.4; Huf 3.5; SE1C1; SE1C2; SE1S; TTC			RDKS

		B8, B81	A4 / A4 Avant		
	CS	lichtsilber-lackiert		Celsio	CS 808 35 5 12
		lichtsilber-lackiert / mattschwarz-lackiert		Interio	IN 808 35 5 12
		Rad auch für Modelle S4	ABE	225/45R18 M+S 235/40R18 M+S	8 J x18 EH2+ 5 x 112 ET 35
	ABE	235/40R18 M+S			
MK 307		Celsio: ASC; ASS; CUC; Huf 2.4; Huf 3.4; Huf 3.5; SE1C1; SE1C2; SE1S; TTC Interio: CUC; Huf 3.4; SE1C1; SE1S			RDKS

		B8, B81	A4 Allroad		
	SO	lichtsilber-lackiert / mattschwarz-lackiert		Seismo	SO 757 25 5 12
			ABE	225/55R17 M+S 235/50R17 M+S	7½ J x17 H2 5 x 112 ET 25
			ABE	235/50R17 M+S	
MK 307		ASC; CUC; CUS; Huf 2.4; Huf 3.4; SE1C1; SE1C2; SE1S; TTC			RDKS

		A4 (Neues Modell)	
Radabbildung in Vorbereitung			in Vorbereitung
		RDKS	



KRONPRINZ
MAGMA



KRONPRINZ
MAGMA

KRONPRINZ
MAGMA

KRONPRINZ
MAGMA

KRONPRINZ
MAGMA



A5 / Cabriolet / Sportback				B8, B81	
MAGNA	Celsio		CS 807 35 5 12	lichtsilber-lackiert	
	Interio		IN 807 35 5 12	lichtsilber-lackiert / mattschwarz-lackiert	
	8 J x17 EH2+	225/50R17	ABE	Räder nicht frei für Modell S5	
	5 x 112	235/50R17	ABE		
ET 35	245/45R17	ABE			
RDKS	Celsio: ASC; ASS; CUC; Huf 2.4; Huf 3.4; Huf 3.5; SE1C1; SE1S Interio: ASC; CUC; Huf 3.5; SE1C1; SE1S			MK 307	
					

A5 / S5 / Cabriolet / Sportback				B8, B81		
MAGNA	Tezzo		TZ 858 30 5 12	lichtsilber-lackiert / mattschwarz-lackiert		
	8½ J x18 H2		225/45R18	ABE		
	5 x 112	235/40R18	ABE			
	ET 30	245/40R18	ABE			
RDKS	ASC; ASS; CUC; Huf 2.4; Huf 3.4; Huf 3.5; SE1C1; SE1C2; SE1S; TTC			MK 307		



A6		05/97-08/99	4B	
Stahl	*AD 515008	8860	152504	Stufenheck, Avant
	6 J x15 H2	195/65R15 M+S	1,8/1,8T/2,0/2,0/2,4/2,8/Quattro/1,9TDI/2,5TDI	
	5x112x57	205/60R15		
	ET 45			
RDKS	€ 65,50	Kugel sw 17 M14 x 1,5 x 27	Ab 09/99 nur noch 16"-Räder zulässig; Alle Fahrzeuge >142 kW nur LM-Guss Räder. Allroad Quattro nur LM-Guss Räder.	
				

A6		08/99-04/04	4B	
Stahl	*AD 516004	9490	162201	Stufenheck, Avant
	6 J x16 H2	205/55R16 M+S	1,8/1,8T/2,0/2,0/2,4/2,8/Quattro/1,9TDI	
	5x112x57			
	ET 40			
RDKS	€ 81,40	Kugel sw 17 M14 x 1,5 x 27	Ab 09/99 nur noch 16"-Räder zulässig. Alle Fahrzeuge > 142 kW nur LM-Guss Räder. Audi A6 2,5 TDI >12/2002 (ab EGBE E1*98/14*0051*20) nur LM-Guss Räder zulässig. Allroad Quattro nur LM-Guss Räder.	
				



A6		08/99-12/02	4B	
Stahl	*AD 516004	9490	162201	Stufenheck, Avant
	6 J x16 H2	205/55R16 M+S	2,5 TDI	
	5x112x57			
	ET 40			
RDKS	€ 81,40	Kugel sw 17 M14 x 1,5 x 27	Ab 09/99 nur noch 16"-Räder zulässig. Allroad Quattro nur LM-Guss Räder. Audi A6 2,5 TDI > 12/2002 (ab EGBE E1*98/14*0051*20) nur LM-Guss Räder zulässig.	
				

		4F, 4F1		A6 / A6 Avant		
CS		lichtsilber-lackiert	Celsio		CS 706 38 5 12	MAGNA
			lichtsilber-lackiert / mattschwarz-lackiert	Interio		
		ABE		205/60R16	7 J x16 EH2+	
		ABE	225/55R16 M+S	ET 38		
IN		MK 306		Celsio: ASC; CUC; Huf 3.4; Huf 3.5; SE1C1; SE15 Interio: ASC; CUC; Huf 2.4; Huf 3.4; Huf 3.5; SE1C1; SE15 / OE: Huf 100108		RDKS

		4F, 4F1		A6 / A6 Avant		
CS		lichtsilber-lackiert	Celsio		CS 707 45 5 12	MAGNA
				Interio		
		ABE		205/55R17	7 J x17 EH2+	
		ABE	225/50R17	ET 45		
	MK 306			ASC; ASS; CUC; Huf 2.4; Huf 3.4; Huf 3.5; SE1C1; SE1C2; SE15; TTC / OE: Huf 100108		RDKS

		4F, 4F1		A6 Allroad		
CS		lichtsilber-lackiert	Celsio		CS 807 35 5 12	MAGNA
			lichtsilber-lackiert / mattschwarz-lackiert	Interio		
		ABE		215/55R17	8 J x17 EH2+	
		ABE	225/55R17	ET 35		
IN		MK 306		Celsio: ASC; ASS; CUC; Huf 2.4; Huf 3.4; Huf 3.5; SE1C1; SE15 / OE: Huf 100108 Interio: ASC; CUC; Huf 3.5; SE1C1; SE15		RDKS

		4G, 4G1		A6 / A6 Avant / A7			
TZ		lichtsilber-lackiert / mattschwarz-lackiert	Tezzo		TZ 757 35 5 12	MAGNA	
			A7 nur Bereifung 235/55R17 M+S + 245/50R17 M+S / Bremsanlage beachten A6 + A7	ABE	225/55R17		7½ J x17 H2
		ABE		235/55R17			
		ABE		245/50R17	ET 35		
	MK 307			ASC; ASS; CUC; Huf 2.4; Huf 3.4; Huf 3.5; SE1C1; SE1C2; SE15		RDKS	

		4G, 4G1		A6 / A6 Avant / A7			
CS		lichtsilber-lackiert	Celsio		CS 808 35 5 12	MAGNA	
			lichtsilber-lackiert / mattschwarz-lackiert	Interio			IN 808 35 5 12
		A7 nur Bereifung 235/50R18 + 245/45R18 / A6 nur Bereifung 225/50R18 + 245/45R18		ABE	225/50R18		8 J x18 EH2
			ABE	235/50R18			
ABE	245/45R18		ET 35				
IN		MK 307		Celsio: ASC; ASS; CUC; Huf 2.4; Huf 3.4; Huf 3.5; SE1C1; SE1C2; SE15; TTC Interio: CUC; Huf 3.4; SE1C1; SE15		RDKS	

A6 Allroad				4G
MAGNA	Celsio		CS 808 45 5 12	lichtsilber-lackiert
	8 J x18 H2	235/55R18	ABE	Achtung! Bremsanlage beachten
	5 x 112			
	ET 45			
RDKS	ASC; ASS; CUC; Huf 2.4; Huf 3.4; Huf 3.5; SE1C1; SE1C2; SE1S; TTC			MK 307



CS

A8				4E
MAGNA	Celsio		CS 807 35 5 12	lichtsilber-lackiert
	Interio		IN 807 35 5 12	lichtsilber-lackiert / mattschwarz-lackiert
	8 J x17 EH2+	235/55R17	ABE	Achtung! Bremsanlage beachten
	5 x 112			
ET 35				
RDKS	Celsio: ASC; ASS; CUC; Huf 2.4; Huf 3.4; Huf 3.5; SE1C1; SE1S Interio: ASC; CUC; Huf 3.5; SE1C1; SE1S			MK 306



CS



IN

A8				4H
MAGNA	Tezzo		TZ 757 35 5 12	lichtsilber-lackiert / mattschwarz-lackiert
	7½ J x17 H2	235/60R17 M+S	ABE	Achtung! Bremsanlage beachten
	5 x 112	245/55R17M+S	ABE	
	ET 35	245/60R17M+S	ABE	
RDKS	ASC; ASS; CUC; Huf 2.4; Huf 3.4; Huf 3.5; SE1C1; SE1C2; SE1S / OE: Huf 100108			MK 321



TZ





TZ

Q1		2016-
Stahl	INFO	SUV
		INFO
RDKS		



Radabbildung
in
Vorbereitung

Q1	
MAGNA	in Vorbereitung
RDKS	



Radabbildung
in
Vorbereitung

		8U, 8U1		Q3	
		lichtsilber-lackiert / mattschwarz-lackiert		Tezzo	TZ 756 42 5 12
			ABE	215/65R16 *	7½ J x16 H2 5 x 112 ET 42
			ABE	225/60R16 *	
			ABE	235/60R16	
TZ	MK 306	ASC; ASS; CUC; Huf 2.4; Huf 3.4; Huf 3.5; SE1C1; SE1C2; SE1S; TTC			RDKS



KRONPRINZ
MAGNA

		8U, 8U1		Q3	
		lichtsilber-lackiert / mattschwarz-lackiert		Interio	IN 807 35 5 12
		lichtsilber-lackiert / mattschwarz-lackiert		Tezzo	TZ 807 35 5 12
			ABE	215/60R17 *	8 J x17 H2 5 x 112 ET 35
			ABE	225/55R17 *	
	ABE	235/55R17 *			
IN	TZ	MK 306	Interio: ASC; CUC; Huf 3.5; SE1C1; SE1S Tezzo: ASC; ASS; CUC; Huf 2.4; Huf 3.4; Huf 3.5; SE1C1; SE1C2; SE1S; TTC		



KRONPRINZ
MAGNA

		8R, 8R1		Q5 / QS5	
		lichtsilber-lackiert / mattschwarz-lackiert		Tezzo	TZ 757 35 5 12
			ABE	225/65R17M+S *	7½ J x17 H2 5 x 112 ET 35
			ABE	235/60R17M+S *	
			ABE	235/65R17M+S *	
TZ	TZ	MK 307	ASC; ASS; CUC; Huf 2.4; Huf 3.4; Huf 3.5; SE1C1; SE1C2; SE1S		

KRONPRINZ
MAGNA



		8R, 8R1		Q5 / QS5	
		lichtsilber-lackiert		Celsio	CS 807 35 5 12
		lichtsilber-lackiert / mattschwarz-lackiert		Interio	IN 807 35 5 12
			ABE	225/65R17M+S *	8 J x17 EH2+ 5 x 112 ET 35
			ABE	235/60R17M+S *	
	ABE	235/65R17M+S *			
CS	IN	MK 307	Celsio: ASC; ASS; CUC; Huf 2.4; Huf 3.4; Huf 3.5; SE1C1; SE1S Interio: ASC; CUC; Huf 3.5; SE1C1; SE1S		



KRONPRINZ
MAGNA

		4L		Q7	
		lichtsilber-lackiert / mattschwarz-lackiert		Seismo	SO 808 55 5 30
			ABE	235/60R18 *	8 J x18 H2 5 x 130 ET 55
			ABE	235/60R18 M+S *	
			ABE	255/55R18	
SO	SO	Serie	ASC; ASS; CUC; Huf 2.4; Huf 3.4; SE1C1; SE1C2; SE1S; TTC / OE: Huf 100108		

KRONPRINZ
MAGNA

Q7 (Neues Modell)				4L
KRONPRINZ MAGMA	in Vorbereitung			Radabbildung in Vorbereitung
RDKS				



TT / TTS				8J	
KRONPRINZ MAGMA	Celsio	CS 706 45 5 12	lichtsilber-lackiert	 	
	Interio	IN 706 45 5 12	lichtsilber-lackiert / mattschwarz-lackiert		
	7 J x16 EH2+	225/55R16 M+S ❄	ABE		nur für Fahrzeuge bis 155 KW
	5 x 112				
	ET 45				
RDKS Celsio: ASC; CUC; Huf 3.4; Huf 3.5; SE1C1; SE1S Interio: ASC; CUC; Huf 2.4; Huf 3.4; Huf 3.5; SE1C1; SE1S				MK 306	

TT / TTS				8J
KRONPRINZ MAGMA	Interio	IN 807 50 5 12	lichtsilber-lackiert / mattschwarz-lackiert	 
	8 J x17 EH2+	225/50R17 ❄	ABE	
	5 x 112	235/45R17 ❄	ABE	
	ET 50	245/45R17 ❄	ABE	
RDKS ASC; CUC; Huf 3.5; SE1C1; SE1S				MK 306

TT / TTS (Neues Modell)				8J
KRONPRINZ MAGMA	in Vorbereitung			Radabbildung in Vorbereitung
RDKS				

		182, 1C	11/07-02/14	1er-Reihe (E82)	
	Coupé	164901	9153	BM 516018	Stahl
	120i/ 125i/ 118d/ 120d	195/55R16 M+S		6½ J x16 EH2+ 5x120x72,5 ET 42	
	Beim 123d/135i sind keine 16 Zoll-Räder zulässig.	Kegel sw 17 M12 x 1,5 x 26		€ 81,40	
RDKS					
		182, 1C	11/07-02/14	1er-Reihe (E82)	
	Coupé	165001	9577	BM 516019	Stahl
	120i/ 118d/ 120d	205/55R16		7 J x16 EH2+ 5x120x72,5 ET 44	
	125i	205/55R16 M+S			
Beim 123d/135i sind keine 16 Zoll-Räder zulässig.	Kegel sw 17 M12 x 1,5 x 26		€ 80,80		
RDKS					
		187, 1K2, 1K4	05/07-09/11	1er-Reihe (E87)	
	Steilheck	164901	9153	BM 516018	Stahl
	116i/ 118i/ 120i/ 116d/ 118d/ 120d (110/120 kW)	195/55R16		6½ J x16 EH2+ 5x120x72,5 ET 42	
	120d (130 kW)	195/55R16 M+S			
Beim 123d/130i sind keine 16 Zoll-Räder zulässig.	Kegel sw 17 M12 x 1,5 x 26		€ 81,40		
RDKS					
		187, 1K2, 1K4	05/07-09/11	1er-Reihe (E87)	
	Steilheck	165001	9577	BM 516019	Stahl
	116i/ 118i/ 120i/ 125i/ 116d/ 118d/ 120d	205/55R16		7 J x16 EH2+ 5x120x72,5 ET 44	
	Beim 123d/130i sind keine 16 Zoll-Räder zulässig.	Kegel sw 17 M12 x 1,5 x 26		€ 80,80	
RDKS					
		182, 1C	03/08-02/15	1er-Reihe (E88)	
	Cabrio	164901	9153	BM 516018	Stahl
	118i/120i/ 118d	195/55R16 M+S		6½ J x16 EH2+ 5x120x72,5 ET 42	
	Cabrio: Nicht zulässig für 125i/ 120d. Beim 123d/135i sind keine 16 Zoll-Räder zulässig.	Kegel sw 17 M12 x 1,5 x 26		€ 81,40	
RDKS					



1er-Reihe (E88)			03/08-02/15	182, 1C	
Stahl	BM 516019	9577	165001	Cabrio	
	7 J x16 EH2+	205/55R16		118i/120i/ 118d/ 120d	
	5x120x72,5	205/55R16 M+S		125i	
	ET 44				
€ 80,80		Kegel sw 17 M12 x 1,5 x 26		Beim 123d/135i sind keine 16 Zoll-Räder zulässig.	
RDKS					

1er-Reihe (E82/E87/E88)				187, 1K2, 1K4, 182, 1C			
MAGNUM	Celsio	CS 706 45 5 20	lichtsilber-lackiert				
	Interio	IN 706 45 5 20	lichtsilber-lackiert / mattschwarz-lackiert				
	7 J x16 EH2+	195/55R16 M+S	ABE				
	5 x 120	205/55R16	ABE				
ET 45							
RDKS				Celsio: ASC; CUC; Huf 3.4; Huf 3.5; SE1C1; SE1S Interio: ASC; CUC; Huf 2.4; Huf 3.4; Huf 3.5; SE1C1; SE1S	MK 202	CS	IN



1er-Reihe (F20/F21)			10/11-07/13	1K2, 1K4	
Stahl	*BM 516021	9243	165701	Steilheck	
	6½ J x16 H2	195/55R16		114i/116i/118i/114d/116d/118d/120d	
	5x120x72,5				
	ET 33				
€ 80,80		Kegel sw 17 M14 x 1,25 x 30,5		Einige Ausführungen nur 7 J x 16 H2 ET40 zulässig!	
RDKS					

1er-Reihe (F20/F21)			08/13-	1K2, 1K4	
Renner	BM 516025	9244	16570101	Steilheck	
	6½ J x16 H2	195/55R16		114i/116i/118i/120i/114d/116d/118d/120d	
	5x120x72,5				
	ET 33				
€ 80,80		Kegel sw 17 M14 x 1,25 x 30,5		Einige Ausführungen nur 7 J x 16 H2 ET40 zulässig! Ersetzt BM 516021.	
RDKS					
ASC; ASS; CUC; Huf 2.4; Huf 3.4; Huf 3.5; SE1C1; SE1C2; SE2C1; SE2C2; SE1S; SE2S; TTC; TTS / OE: VDO S180052056Z					

1er-Reihe (F20/F21)			08/13-	1K2, 1K4	
Renner	BM 516026	9613	16580101	Steilheck	
	7 J x16 H2	205/55R16		114i/116i/118i/120i/114d/116d/118d/120d/125d/125i	
	5x120x72,5				
	ET 40				
€ 80,80		Kegel sw 17 M14 x 1,25 x 30,5		Ersetzt BM 516022.	
RDKS					
ASC; ASS; CUC; Huf 2.4; Huf 3.4; Huf 3.5; SE1C1; SE1C2; SE2C1; SE2C2; SE1S; SE2S; TTC; TTS / OE: VDO S180052056Z					



		1K2, 1K4	1er-Reihe (F20/F21)		
		lichtsilber-lackiert		Celsio	CS 706 45 5 20
		lichtsilber-lackiert / mattschwarz-lackiert		Interio	IN 706 45 5 20
		Bremsanlage beachten	ABE	195/55R16 ❄️	7 J x16 EH2+
			ABE	205/55R16 ❄️	
ABE	215/50R16 ❄️		ET 45		
MK 404		Celsio: ASC; CUC; Huf 3.4; Huf 3.5; SE1C1; SE15 Interio: ASC; CUC; Huf 2.4; Huf 3.4; Huf 3.5; SE1C1; SE15			RDKS

		1C	03/14-	2er-Reihe (F22)		
	Coupé	16580101	9613	BM 516026		
	218i/ 218d/ 220d/ 220i	205/55R16		7 J x16 H2		
	Nicht Cabrio (F23)!	Kegel sw 17 M14 x 1,25 x 30,5		5x120x72,5		
				ET 40		
				€ 80,80		
		ASC; ASS; CUC; Huf 2.4; Huf 3.4; Huf 3.5; SE1C1; SE1C2; SE2C1; SE2C2; SE15; SE25; TTC; TTS / OE: VDO S180052056Z				RDKS

		1C	2er-Reihe (F22/F23)		
		lichtsilber-lackiert		Celsio	CS 706 45 5 20
		lichtsilber-lackiert / mattschwarz-lackiert		Interio	IN 706 45 5 20
		Bremsanlage beachten	ABE	205/55R16 ❄️	7 J x16 EH2+
			ABE	215/50R16 ❄️	
MK 404		Celsio: ASC; CUC; Huf 3.4; Huf 3.5; SE1C1; SE15 Interio: ASC; CUC; Huf 2.4; Huf 3.4; Huf 3.5; SE1C1; SE15			RDKS

		UKL-L	09/14-06/15	2er Active Tourer (F45)		
	Van	166102	7502	BM 516029		
	218i/ 216d	195/65R16 M+S		7 J x16 H2		
	Ab 07/15- keine Stahlräder mehr zulässig! Nicht zulässig für Gran Tourer! Schneekettenmontage möglich.	Kegel sw 17 M14 x 1,25 x 30,5		5x112x66,5		
				ET 47		
				€ 80,80		
		ASC; ASS; CUC; Huf 2.4; Huf 3.4; Huf 3.5; SE1C1; SE1C2; SE2C1; SE2C2; SE15; SE25; TTC; TTS / OE: VDO S180052056Z				RDKS

		UKL-L	2er Active Tourer (F45)			
Radabbildung in Vorbereitung	Van			in Vorbereitung		
						RDKS

3er-Reihe (E46)			346C/L/R/K/X		
MAGNA	Celsio	CS 706 45 5 20	lichtsilber-lackiert		
	Interio	IN 706 45 5 20	lichtsilber-lackiert / mattschwarz-lackiert		
	7 J x16 H2	205/55R16	ABE		
	5 x 120	205/55R16 M+S *	ABE		
ET 45	225/50R16	ABE			
RDKS		Celsio: ASC; CUC; Huf 3.4; Huf 3.5; SE1C1; SE1S Interio: ASC; CUC; Huf 2.4; Huf 3.4; Huf 3.5; SE1C1; SE1S			
			MK 202	CS	IN

3er-Reihe (E90/E91/E92/E93)		09/07-02/12	390L, 3L, 3K, 392C, 3C	
Stahl	BM 516020	9557	165101	Stufenheck, Touring, Coupé, Cabrio
	7 J x16 EH2+	205/55R16		318i/ 320i/ 325i/ 316d/ 318d/ 320d
	5x120x72,5	225/50R16		
	ET 31	205/55R16 M+S		Touring/Coupé
€ 84,00		Kegel sw 17 M12 x 1,5 x 26		FZG-Schein beachten. Cabrio/Coupé/Touring nur 205/55R16 M+S.
RDKS				



3er-Reihe (E90/E91/E92/E93)			390L, 3L, 3K, 390X, 392C, 3C		
MAGNA	Tezzo	TZ 756 30 5 20	lichtsilber-lackiert / mattschwarz-lackiert		
	7½ J x16 H2	205/55R16 *	ABE		
	5 x 120	205/55R16 M+S *	ABE		
	ET 30				
RDKS		ASC; ASS; CUC; Huf 2.4; Huf 3.4; Huf 3.5; SE1C1; SE1C2; SE1S; TTC			
			MK 202	TZ	TZ





3er-Reihe (F30/F31)		03/12-07/13	3K, 3L	
Stahl	*BM 516023	8007	165901	Stufenheck, Touring
	7 J x16 H2	205/60R16		316i/ 320i/ 316d/ 318d/ 320d
	5x120x72,5			
	ET 31			
€ 84,00		Kegel sw 17 M14 x 1,25 x 30,5		
RDKS				



3er-Reihe (F30/F31)		08/13-	3K, 3K-N1, 3L	
Renner	BM 516027	8008	16590101	Stufenheck, Touring
	7 J x16 H2	205/60R16		316i/ 320i/ 316d/ 318d/ 320d
	5x120x72,5			
	ET 31			
€ 84,00		Kegel sw 17 M14 x 1,25 x 30,5		Ersetzt BM 516023.
RDKS		ASC; ASS; CUC; Huf 2.4; Huf 3.4; Huf 3.5; SE1C1; SE1C2; SE2C1; SE2C2; SE1S; SE2S; TTC; TTS / OE: VDO S180052056Z		





		3K, 3L		3er-Reihe (F30/F31)	
		lichtsilber-lackiert / mattschwarz-lackiert		Tezzo	TZ 756 30 5 20
		Bei Bereifung 225/55R16 Auflagen beachten!		ABE 205/60R16 * TÜV 225/55R16	7½ J x16 H2 5 x 120 ET 30
		MK 403		ASC; ASS; CUC; Huf 2.4; Huf 3.4; Huf 3.5; SE1C1; SE1C2; SE1S; TTC / OE: VDO S180052056Z	

KRONPRINZ
MAGMA

		3K, 3L		3er-Reihe (F30/F31)	
		lichtsilber-lackiert		Celsio	CS 807 38 5 20
				ABE 205/55R17 * ABE 215/50R17 * ABE 225/50R17 *	8 J x17 EH2+ 5 x 120 ET 38
		MK 403		ASC; ASS; CUC; Huf 2.4; Huf 3.4; Huf 3.5; SE1C1; SE1S / OE: VDO S180052056Z	

KRONPRINZ
MAGMA

		3-V		3er Gran Turismo (F34)	
		lichtsilber-lackiert / mattschwarz-lackiert		Interio	IN 807 30 5 20
				ABE 225/55R17 *	8 J x17 EH2+ 5 x 120 ET 30
		MK 403		ASC; CUC; Huf 3.5; SE1C1; SE1S	

KRONPRINZ
MAGMA



		3C		4er-Reihe Gran Coupé (F36)	
	Coupé 418d (105 kW)	16590101	8008	BM 516027	
		205/60R16		7 J x16 H2 5x120x72,5 ET 31	
				€ 84,00	
				ASC; ASS; CUC; Huf 2.4; Huf 3.4; Huf 3.5; SE1C1; SE1C2; SE2C1; SE2C2; SE1S; SE2S; TTC; TTS / OE: VDO S180052056Z	

Renner



RDKS

		3C		4er Reihe (F36)	
		lichtsilber-lackiert / mattschwarz-lackiert		Tezzo	TZ 807 35 5 20
				ABE 225/50R17 * ABE 235/45R17 * ABE 245/45R17	8 J x17 H2 5 x 120 ET 35
		MK 403		ASC; ASS; CUC; Huf 2.4; Huf 3.4; Huf 3.5; SE1C1; SE1C2; SE1S; TTC / OE: VDO S180052056Z	

KRONPRINZ
MAGMA

5er-Reihe (E60)				560L	
MAGNA	Celsio		CS 706 20 5 20	lichtsilber-lackiert	
	Seismo		SO 706 20 5 20	lichtsilber-lackiert / mattschwarz-lackiert	
	7 J x16 H2	205/60R16	⊗	ABE	 
	5 x 120	205/60R16M+S	⊗	ABE	
ET 20	225/55R16	⊗	ABE		
RDKS Celsio: ASC; CUC; Huf 3.4; Huf 3.5; SE1C1; SE15 Seismo: ASC; ASS; CUC; Huf 2.4; Huf 3.4; SE1C2; SE15; TTC; TTS				MK 201	

5er-Reihe (E60)				560L	
MAGNA	Celsio		CS 807 20 5 20	lichtsilber-lackiert	
	8 J x17 H2	225/50R17	ABE		
	5 x 120	235/45R17	ABE		
	ET 20	245/45R17	ABE		
RDKS ASC; ASS; CUC; Huf 2.4; Huf 3.4; Huf 3.5; SE1C1; SE15					MK 201



5er-Reihe (E60) -Allrad-				560X	
MAGNA	Tezzo		TZ 807 35 5 20	lichtsilber-lackiert / mattschwarz-lackiert	
	8 J x17 H2	225/50R17	⊗	ABE	 
	5 x 120	235/45R17		ABE	
	ET 35	245/45R17		ABE	
RDKS ASC; ASS; CUC; Huf 2.4; Huf 3.4; Huf 3.5; SE1C1; SE1C2; SE15; TTC				MK 202	

5er-Reihe (F10/F11)				5L, 5K, K-N1	
MAGNA	Interio		IN 807 30 5 20	lichtsilber-lackiert / mattschwarz-lackiert	
	8 J x17 EH2+	225/55R17	⊗	ABE	 
	5 x 120				
	ET 30				
RDKS ASC; CUC; Huf 3.5; SE1C1; SE15				MK 403	

5er-Reihe (F10/F11)				5L, 5K, K-N1	
MAGNA	Tezzo		TZ 807 35 5 20	lichtsilber-lackiert / mattschwarz-lackiert	
	8 J x17 H2	225/55R17	⊗	ABE	 
	5x 120	235/50R17	⊗	ABE	
	ET 35				
RDKS ASC; ASS; CUC; Huf 2.4; Huf 3.4; Huf 3.5; SE1C1; SE1C2; SE15; TTC / OE: Huf 100055				MK 403	

		GT, K-N1	5er-Reihe Gran Turismo (F07)		
		lichtsilber-lackiert / mattschwarz-lackiert		Interio	IN 808 30 5 20
		Rad nicht frei für Allrad Modelle / Achtung Bremsanlage beachten	ABE	245/50R18 ✱	8 J x18 EH2+ 5 x 120 ET 30
	ABE	255/50R18 ✱			
IN	IN	MK 403	CUC; Huf 3.4; SE1C1; SE1S / OE: Huf 100055		RDKS

MAGMA



		701, 7L	7er Reihe (F01/FO02)		
		lichtsilber-lackiert / mattschwarz-lackiert		Interio	IN 807 30 5 20
		Achslast beachten!	ABE	245/50R17 ✱	8 J x17 EH2+ 5 x 120 ET 30
	ABE	245/55R17 ✱			
	ABE	255/50R17 ✱			
IN	IN	MK 403	ASC; CUC; Huf 3.5; SE1C1; SE1S		RDKS

MAGMA

		X1	10/09-09/15	X1 (E84)	
	SUV		176001	9863	BM 517005
	18i/ 20i/ 25i/ 28i/ 16d/ 18d/ 20d/ 23d/ 25d		225/50R17		7½ J x17 EH2+ 5x120x72,5 ET 34
			Kegel sw 17 M12 x 1,5 x 26		€ 105,10
			ASC; CUC; Huf 2.4; Huf 3.4; SE1C1 / OE: Huf 100055		

Renner

RDKS

		X1	X1 (E84)		
		lichtsilber-lackiert / mattschwarz-lackiert		Tezzo	TZ 807 35 5 20
			ABE	235/45R17 ✱	8 J x17 H2 5 x 120 ET 35
TZ	TZ	MK 202	ASC; ASS; CUC; Huf 2.4; Huf 3.4; Huf 3.5; SE1C1; SE1C2; SE1S; TTC / OE: Huf 100055		

MAGMA

RDKS

		X1 (Neues Modell)		
Radabbildung in Vorbereitung				in Vorbereitung

MAGMA

RDKS

X3 (E83)				X83	
MAGNA	Interio		IN 807 30 5 20		lichtsilber-lackiert / mattschwarz-lackiert
	8 J x17 EH2+ 5 x 120 ET 30	215/60R17 M+S	ABE	225/55R17: Serienbereifung beachten!	
		225/55R17	ABE		
RDKS	ASC; CUC; Huf 3.5; SE1C1; SE15			MK 313	
				IN	IN



X3 (F25)				X3, X-N1	
MAGNA	Tezzo		TZ 807 35 5 20		lichtsilber-lackiert / mattschwarz-lackiert
	8 J x17 H2 5 x 120 ET 35	215/60R17 M+S ❄	ABE		
		225/60R17 ❄	ABE		
RDKS	ASC; ASS; CUC; Huf 2.4; Huf 3.4; Huf 3.5; SE1C1; SE1C2; SE15; TTC / OE: Huf 100055			MK 403	
				TZ	TZ



X4 (F26)				X3, X-N1	
MAGNA	in Vorbereitung				Radabbildung in Vorbereitung
RDKS					

X5 (E53)				X53	
MAGNA	Interio		IN 807 30 5 20		lichtsilber-lackiert / mattschwarz-lackiert
	8 J x17 EH2+ 5 x 120 ET 30	235/65R17	ABE		
		235/65R17 M+S	ABE		
RDKS	ASC; CUC; Huf 3.5; SE1C1; SE15			Serie	
				IN	IN



X5 (E70)				X70, X5, X-N1	
MAGNA	Tezzo		TZ 858 45 5 20		lichtsilber-lackiert / mattschwarz-lackiert
	8½ J x18 H2 5 x 120 ET 45	255/55R18 ❄	ABE		
RDKS	ASC; ASS; CUC; Huf 2.4; Huf 3.4; Huf 3.5; SE1C1; SE1C2; SE15; TTC			Serie	
				TZ	TZ



		X5, X-N1	X5 (F15) (Neues Modell)		
Radabbildung in Vorbereitung					MAGMA
				in Vorbereitung	
					RDKS

		Z85	Z4 (E85)				
CS		IN	lichtsilber-lackiert		Celsio	CS 706 45 5 20	MAGMA
			lichtsilber-lackiert / mattschwarz-lackiert		Interio	IN 706 45 5 20	
			bei 170 kW nur 225/50R16 M+S	ABE	205/55R16 M+S ❄	7 J x16 EH2+	
				ABE	225/50R16		
				ET 45			
MK 202		Celsio: ASC; CUC; Huf 3.4; Huf 3.5; SE1C1; SE1S Interio: ASC; CUC; Huf 2.4; Huf 3.4; Huf 3.5; SE1C1; SE1S					RDKS

		Z89, ZR	Z4 (E89)				
TZ		TZ	lichtsilber-lackiert / mattschwarz-lackiert		Tezzo	TZ 807 35 5 20	MAGMA
				ABE	225/45R17	8 J x17 H2	
				ABE	235/40R17		
						ET 35	
MK 202		ASC; ASS; CUC; Huf 2.4; Huf 3.4; Huf 3.5; SE1C1; SE1C2; SE1S; TTC / OE: Huf 100055					RDKS

CHEVROLET / DAEWOO

		KLAS	02/06-06/11	Aveo		
	3-/4-/5-Türer 1,2i (53/62 kW)/ 1,4i-16V (69/74 kW)	133571	4040	DJ 513002		Stahl
		155/80R13		5 J x13 CH 4x100x56,5 ET 45		
		Kegel sw 19 M12 x 1,5/H15		€ 57,10		
						RDKS

Aveo		02/06-06/11	KLAS	
Stahl	DJ 514002	6565	143700	3-/4-/5-Türer
	5½ J x14 H2	185/60R14		1,2i (53/62 kW) / 1,4i-16V (69/74 kW)
	4x100x56,5 ET 45			
€ 69,70		Kegel sw 19 M12 x 1,5/H15		
RDKS				

Aveo		07/11-	KL1T	
Stahl	CV 515001	8613	154527	4-/5-Türer
	6 J x15 H2	195/65R15		1,2i (51/63 kW) / 1,4i (74 kW)
	4x100x56,5 ET 39			
€ 71,30		Kegel sw 19 M12 x 1,5/H15		
RDKS		ASC; ASS; CUC; CUS; Huf 2.4; Huf 3.4; Huf 3.5; SE1C2; SE2C2; SE2S; TTC / OE: Schrader 3049		

Aveo		07/11-	KL1T	
Stahl	CV 515002	7710	154528	4-/5-Türer
	6 J x15 H2	195/65R15		1,6i (85 kW) / 1,3D (55/70 kW)
	5x105x56,5 ET 39			
€ 71,30		Kegel sw 19 M12 x 1,5/H15		
RDKS		ASS; CUS; Huf 3.5; SE1S; TTS / OE: Schrader 3049		

Captiva		09/06-	KLAC	
Stahl	OP 516011	7885	163336	SUV
	6½ J x16 H2	215/70R16		2,4i (100/123 kW) / 2,0 CRD (110 kW) / 2,2 TD (120 kW)
	5x115x70,2 ET 46	215/70R16 M+S		2,4i (100/123 kW) / 2,0 CRD (110 kW) / 3,2 V6 (169 kW) / 3,0 V6 (190 kW) / 2,2 TD (120/135 kW)
	€ 108,30	Kegel sw 19 M12 x 1,5/H15		Baugleich mit Opel Antara. Einige Ausführungen nur 17 Zoll.
RDKS		ASC; ASS; CUC; CUS; Huf 3.5; SE1S; SE2S / OE: Schrader 3049		

Captiva			KLAC, KLAD, CHIC, CHIC-NA			
KRONPRINZ MAGNA	Celsio	CS 656 40 5 15	lichtsilber-lackiert			
	Tezzo	TZ 656 40 5 15	lichtsilber-lackiert / mattschwarz-lackiert			
	6½ J x16 H2	215/70R16 M+S ❄	ABE			
	5 x 115	225/65R16 ❄	ABE			
ET 40	225/70R16	ABE				
RDKS			Celsio: ASC; ASS; CUC; Huf 2.4; Huf 3.4; Huf 3.5; SE1C1; SE1C2; SE1S; TTC; TTS / OE: Schrader 3049 Tezzo: ASC; ASS; CUC; Huf 2.4; Huf 3.4; Huf 3.5; SE1C1; SE1C2; SE1S; TTC / OE: Schrader 3049		MK 048	

		CHIR, KL1J	03/09-	Cruze	
	Schräg-/Stufenheck, Kombi	163333	9247	OP 516013	Renner
	1,6i (83/91 kW)/ 1,4T (103 kW)/ 1,8i (104 kW)	205/60R16 215/60R16		6½ J x16 H2 5x105x56,6 ET 39	
	Für Fahrzeuge mit Anschluss: 5x105x56,6 Einige Ausführungen nur 205/60R16!		Kegel sw 19 M12 x 1,5/H15	€ 81,40	RDKS
		ASC; ASS; CUC; Huf 2.4; Huf 3.4; Huf 3.5; SE1C1; SE1C2; SE2C1; SE2C2; SE15; SE25; TTC; TTS / OE: Schrader 3049			

		CHIR, KL1J	Cruze		
		lichtsilber-lackiert	Celsio	CS 656 38 5 05	MAGNA
		lichtsilber-lackiert / mattschwarz-lackiert	Tezzo	TZ 656 38 5 05	
CS	TZ	Lochkreis beachten 5 x 105. 215/60R16 bitte Auflagen / Serienbereifung beachten!	ABE 205/60R16 * ABE 215/60R16	6½ J x16 H2 5 x 105 ET 38	RDKS
		MK 036	Celsio: ASC; ASS; CUC; Huf 2.4; Huf 3.4; Huf 3.5; SE1C1; SE1C2; SE15; TTC; TTS / OE: Schrader 3049 Tezzo: ASC; ASS; CUC; Huf 2.4; Huf 3.4; Huf 3.5; SE1C1; SE1C2; SE15; TTC / OE: Schrader 3049		

		KL1J	03/09-	Cruze	
	Schräg-/Stufenheck, Kombi	163334	9327	OP 516014	Renner
	1,7 D (96 kW)/ 2,0 D (92/110 kW) 2,0 D (120 kW)	205/60R16 205/60R16 215/60R16		6½ J x16 H2 5x115x70,3 ET 41	
	Für Fahrzeuge mit Anschluss: 5x115x70,3		Kegel sw 19 M12 x 1,5/H15	€ 81,40	RDKS
		ASC; ASS; CUC; Huf 2.4; Huf 3.4; Huf 3.5; SE1C1; SE1C2; SE2C1; SE2C2; SE15; SE25; TTC; TTS / OE: Schrader 3049			

		KL1J	Cruze		
		lichtsilber-lackiert	Celsio	CS 656 40 5 15	MAGNA
		lichtsilber-lackiert / mattschwarz-lackiert	Tezzo	TZ 656 40 5 15	
CS	TZ	Lochkreis beachten 5 x 115	ABE 205/60R16 * ABE 215/60R16	6½ J x16 H2 5 x 115 ET 40	RDKS
		MK 048	Celsio: ASC; ASS; CUC; Huf 2.4; Huf 3.4; Huf 3.5; SE1C1; SE1C2; SE15; TTC; TTS / OE: Schrader 3049 Tezzo: ASC; ASS; CUC; Huf 2.4; Huf 3.4; Huf 3.5; SE1C1; SE1C2; SE15; TTC / OE: Schrader 3049		

		KLAL	07/06-12/11	Epica	
	Stufenheck	154656	7970	*DJ 515004	Stahl
	2,0i (105 kW)/ 2,5i (115 kW)/ 2,0 D (110 kW)	205/65R15		6 J x15 CH 4x114,3x56,5 ET 49	
			Kegel sw 19 M12 x 1,5/H15	€ 79,20	RDKS

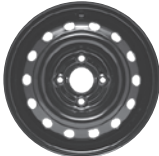
Kalos		09/02-04/08	KLAS	
Stahl	DJ 513002	4040	133571	Schrägheck
	5 J x13 CH	155/80R13		1,2 SE/1,4 SE/1,4 16V SX
	4x100x56,5 ET 45	175/70R13		
	€ 57,10	Kegel sw 19 M12 x 1,5/H15		
RDKS				

Kalos		09/02-04/08	KLAS	
Stahl	DJ 514002	6565	143700	Schrägheck
	5½ J x14 H2	185/60R14		1,2 SE/1,4 SE/1,4 16V SX
	4x100x56,5 ET 45			
	€ 69,70	Kegel sw 19 M12 x 1,5/H15		
RDKS				

Lacetti		03/04-12/10	KLAN	
Stahl	DJ 514003	6555	143795	Schrägheck
	5½ J x14 H2	175/70R14		1,4 SE (70 kW)/ 1,6 SX (80 kW)/ 1,8 CDX (90 kW)
	4x114,3x56,5 ET 44	185/65R14		
	€ 69,70	Kegel sw 19 M12 x 1,5/H15	FZG-Schein beachten.	
RDKS				

Lacetti		03/04-12/10	KLAN	
Stahl	DJ 515003	7985	154655	Schrägheck
	6 J x15 CH	195/55R15		1,4 SE (70 kW)/ 1,6 SX (80 kW)/ 1,8 CDX (90 kW)
	4x114,3x56,5 ET 44			
	€ 79,20	Kegel sw 19 M12 x 1,5/H15	FZG-Schein beachten.	
RDKS				



Matiz		09/98-05/05	KLVA	
Stahl	DJ 513001	2910	133570	Steilheck
	4½ J x13 H2	145/70R13		0,8i (38 kW)/ 1,0i (47 kW)
	4x114,3x69 ET 45	155/65R13		
	€ 51,80	Kegel sw 19 M12 x 1,5/H15		
RDKS				

		KLAK	06/05-02/09	Matiz	
	Steilheck	133570	2910	DJ 513001	Stahl
	0,8S (38 kW) / 1,0 SE/SX (49 kW)	145/70R13		4½ J x13 H2	
		155/65R13		4x114,3x69 ET 45	
			Kegel sw 19 M12 x 1,5/H15	€ 51,80	
RDKS					

		KLAN	07/03-12/10	Nubira J200	
	Stufenheck, Kombi	143795	6555	DJ 514003	Stahl
	1,6 SE/SX (80 kW) / 1,8 CDX (90 kW)	175/70R14		5½ J x14 H2	
		185/65R14		4x114,3x56,5 ET 44	
			Kegel sw 19 M12 x 1,5/H15	€ 69,70	
RDKS					

		KLAN	07/03-12/10	Nubira J200	
	Stufenheck, Kombi	154655	7985	DJ 515003	Stahl
	1,6 SE/SX (80 kW) / 1,8 CDX (90 kW)	195/55R15		6 J x15 CH	
				4x114,3x56,5 ET 44	
			Kegel sw 19 M12 x 1,5/H15	€ 79,20	
RDKS					



CHIO, CHIO-N, F-KL1Y, KL1Y, KL1YN		03/11-	Orlando		
	Van	163334	9327	OP 516014	Renner
	1,4i (103 kW) / 1,8i (104 kW) / 2,0 D (96/120 kW)	215/60R16		6½ J x16 H2	
				5x115x70,3 ET 41	
			Kegel sw 19 M12 x 1,5/H15	€ 81,40	
RDKS					

CHIO, KL1YN, KL1Y		Orlando				
		lichtsilber-lackiert	Celsio	CS 656 40 5 15		
		lichtsilber-lackiert / mattschwarz-lackiert	Tezzo	TZ 656 40 5 15		
			ABE	215/60R16 ❄	6½ x16 H2	
			ABE	225/55R16 ❄	5 x 115	
				ET 40		
MK 048		Celsio: ASC; ASS; CUC; Huf 2.4; Huf 3.4; Huf 3.5; SE1C1; SE1C2; SE15; TTC; TTS / OE: Schrader 3049				
RDKS						

Spark		03/10-	KL1M	
Stahl	CV 513001	3085	133545	Steilheck
	4½ J x13 H2	155/80R13		1,0i (50 kW) / 1,2i (60 kW)
	4x100x56,5	165/70R13		
	ET 45	175/70R13		
	€ 52,30	Kegel sw 19 M12 x 1,5/H15		Sonderrad mit ABE! 155/80R13 nur wenn serienmäßig eingetragen.
RDKS	ASS; SE1S / OE: Schrader 3049			

Spark		03/10-	KL1M	
Stahl	CV 514001	4925	143606	Steilheck
	4½ J x14 H2	155/70R14		1,0i (50 kW) / 1,2i (60 kW)
	4x100x56,5	165/65R14		
	ET 43,5			
	€ 62,30	Kegel sw 19 M12 x 1,5/H15		
RDKS	ASS; Huf 2.4 / OE: Schrader 3049			

Trax		04/13-	KL1B	
Stahl	OP 516015	9272	163338	SUV
	6½ J x16 H2	205/70R16		1,4T (103 kW) / 1,6i (85 kW) / 1,8i (103 kW) / 1,7TD (96 kW) / AWD
	5x105x56,6	215/65R16		
	ET 38			
	€ 81,90	Kegel sw 19 M12 x 1,5/H15		
RDKS	ASC; ASS; CLC; CUC; CUS; Huf 2.4; Huf 3.4; Huf 3.5; SE1C1; SE1S; SE2S; TTC; TTS / OE: Schrader 3049			

Trax			KL1B			
MAGNA	Tezzo	TZ 656 38 5 05	lichtsilber-lackiert / mattschwarz-lackiert			
	6½ x16 H2	205/70R16	⊗	ABE		
	5 x 105	215/65R16	⊗	ABE		
	ET 38	225/60R16	⊗	ABE		
RDKS	ASC; ASS; CUC; Huf 2.4; Huf 3.4; Huf 3.5; SE1C1; SE1C2; SE1S; TTC / OE: Schrader 3049			MK 036	TZ	TZ

		RT	04/08-	Grand Voyager	
	Van	163491	9217	CH 516003	
	3,8i (142 kW)/ 2,8 CRD (120 kW)	225/65R16		6½ J x16 CH 5x127x71,5 ET 40	
		Kegel sw 19 M12 x 1,5/H15		€ 97,20	
		ASC ; ASS ; CUC ; CUS ; Huf 3.5 ; SE1C1 ; SE1C2 ; SE1S ; TTC / OE: Schrader 3007		RDKS	

CITROËN

		M4	09/96-02/03	Berlingo	
	Kasten	143656	6395	PS 614002	
	1,1i/1,4i/1,9D (51 kW)	165/70R14		5½ J x14 CH 4x108x65 ET 24	
	Ab Baujahr 09/02- Radschraube: Kegel sw 17 M12 x 1,25 x 26	Kegel sw 19 M12 x 1,25 x 26		€ 60,20	
				RDKS	

		M*HFZ/FHDZ/KFW/FKFX/NFU/FLFX/WJZ/WJY/FDJY/RHY	09/96-02/03	Berlingo	
	Multispace	143656	6395	PS 614002	
	1,1i/ 1,4i/ 1,6i/ 1,8i/ 1,9D/ 2,0 Hdi	175/65R14		5½ J x14 CH 4x108x65 ET 24	
	Typ: M*HFZ/FHDZ/KFW/FKFX/NFU/FLFX/WJZ/WJY/FDJY/RHY FZG-Schein beachten. Einige Ausführungen mit 175/70R14 Bereifung. Bei einigen Ausführungen nur 15 Zoll zulässig.	Kegel sw 19 M12 x 1,25 x 26		€ 60,20	
				RDKS	

		M NFU, M RHY	09/96-02/03	Berlingo	
	Multispace	154557	8475	PS 515039	
	1,6i-16V (80k W)/ 2,0 HDi (66 kW)	185/65R15		6 J x15 CH 4x108x65 ET 18	
	FZG-Schein beachten! Einige Ausführungen nur 14 Zoll.	Kegel sw 19 M12 x 1,25 x 26		€ 67,10	
				RDKS	

Berlingo			03/03-05/08	M59, M 59 GL, M59 GN	
Stahl	PS 614002	6395	143656	Kasten	
	5½ J x14 CH	175/65R14		1,4i (55 kW) / 1,4 bivalent (55 kW) /	
	4x108x65			1,9D (51 kW) / 1,6 HDi 75 (55 kW) /	
	ET 24			1,6 HDi 90 (66 kW) / 2,0 HDi (66 kW)	
	€ 60,20	Kegel sw 19 M12 x 1,25 x 26			
RDKS					

Berlingo			03/03-05/08	G KFW, G WJY, G RHY, G WJY, G 9HW, G 9HX	
Stahl	PS 614002	6395	143656	Multispace	
	5½ J x14 CH	175/70R14		1,4i (55 kW) / 1,4 bivalent (55 kW) /	
	4x108x65			1,9D (51 kW) / 1,6 HDi 75 (55 kW) /	
	ET 24			1,6 HDi 90 (66 kW) / 2,0 HDi 90 (66 kW)	
	€ 60,20	Kegel sw 19 M12 x 1,25 x 26			
RDKS					

Berlingo			03/03-05/08	G NFU, G RHY, G 9HW, G 9HX	
Stahl	PS 515039	8475	154557	Multispace	
	6 J x15 CH	185/65R15		1,6i-16V (80 kW) / 1,6 HDi 75 (55 kW) /	
	4x108x65			1,6 HDi 90 (66 kW) / 2,0 HDi 90 (66 kW)	
	ET 18				
	€ 67,10	Kegel sw 19 M12 x 1,25 x 26			
RDKS					

Berlingo			06/08-	7	
Stahl	PS 615003	8477	154561	Multispace	
	6½ J x15 H2	195/65R15		1,6i 16V (66/72/80/88 kW) / HDi 75 (55 kW) /	
	4x108x65	195/70R15		HDi 90 (66 kW) / HDi 110 (80 kW)	
	ET 27	205/65R15			
	€ 76,10	Kegel sw 17 M12 x 1,25 x 26		Je nach Ausführung unterschiedliche Reifenabmessungen zulässig.	
RDKS	ASC; ASS; CUC; Huf 2.4; Huf 3.4; Huf 3.5; SE1C1; SE1C2; SE2C1; SE2C2; SE1S; SE2S; TTC / OE: Schrader 3000				

Berlingo			06/08-	B9	
Stahl	PS 615003	8477	154561	Kasten	
	6½ J x15 H2	195/65R15		1,6i 16V (66 kW) / HDi 75 (55 kW) / HDi 90 (66 kW)	
	4x108x65	195/70R15			
	ET 27				
	€ 76,10	Kegel sw 17 M12 x 1,25 x 26			
RDKS	ASC; ASS; CUC; Huf 2.4; Huf 3.4; Huf 3.5; SE1C1; SE1C2; SE2C1; SE2C2; SE1S; SE2S; TTC / OE: Schrader 3000				

		7	06/08-	Berlingo	
	Multispace	163364	7860	PS 516012	Stahl
	1,6i 16V (66/72/80/88 kW)/ HDi 75 (55 kW)/ HDi 90 (66 kW)/ HDi 110 (80 kW)	215/55R16		6½ J x16 H2 4x108x65 ET 26	
	FZG-Schein beachten! Einige Ausführungen nur 15 Zoll.		Kegel sw 17 M12 x 1,25 x 26	€ 77,10	RDKS
			ASC; ASS; CUC; Huf 2.4; Huf 3.4; Huf 3.5; SE1C1; SE1C2; SE2C1; SE2C2; SE1S; SE2S; TTC / OE: Schrader 3000		
		G KFW, G 9HW, G 9HX	06/08-	Berlingo First	
	Multispace	143656	6395	PS 614002	Stahl
	1,4i (54 kW)/ 1,6 HDi 75 (55 kW)/ 1,6 HDi 90 (66 kW)	175/70R14		5½ J x14 CH 4x108x65 ET 24	
	Alte Baureihe des Citroën Berlingo, die parallel zur neuen Baureihe (Typ: 7) weitergebaut wird.		Kegel sw 19 M12 x 1,25 x 26	€ 60,20	RDKS
			ASC; ASS; CUC; Huf 2.4; Huf 3.4; Huf 3.5; SE1C1; SE1C2; SE2C1; SE2C2; SE1S; SE2S; TTC		
		M59	06/08-	Berlingo First	
	Kasten	143656	6395	PS 614002	Stahl
	1,6 HDi 75 (55 kW)	175/65R14		5½ J x14 CH 4x108x65 ET 24	
	Alte Baureihe des Citroën Berlingo, die parallel zur neuen Baureihe (Typ: B9) weitergebaut wird.		Kegel sw 19 M12 x 1,25 x 26	€ 60,20	RDKS
			ASC; ASS; CUC; Huf 2.4; Huf 3.4; Huf 3.5; SE1C1; SE1C2; SE2C1; SE2C2; SE1S; SE2S; TTC		
		G 9HW, G 9HX	06/08-	Berlingo First	
	Multispace	154557	8475	PS 515039	Stahl
	1,6 HDi 75 (55 kW)/ 1,6 HDi 90 (66 kW)	185/65R15		6 J x15 CH 4x108x65 ET 18	
	Alte Baureihe des Citroën Berlingo, die parallel zur neuen Baureihe (Typ: 7) weitergebaut wird.		Kegel sw 19 M12 x 1,25 x 26	€ 67,10	RDKS
		P	07/05-06/14	C1	
	Schrägheck	143765	4940	TO 514017	Stahl
	1,0i (50 kW)/ HDi 55 (40 kW)	155/65R14		4½ J x14 H2 4x100x54 ET 39	
	Bis EGBE: e11*2001/116*0238*10 TO 514017 auch für Peugeot 107/ Toyota Aygo.		Kegel sw 17 M12 x 1,5 x 19	€ 58,10	RDKS

C1		07/14-	P		
Stahl	TO 514021	5770	143720	Schrägheck	
	4½ J x14 H2	165/65R14		1,0i (51 kW)/ 1,2i (60 kW)	
	4x100x54 ET 35				
	€ 58,10			Ab EGBE: e11*2001/116*0238*11	
RDKS					

C1		07/14-	P		
Stahl	TO 515019	7510	154629	Schrägheck	
	4½ J x15 H2	165/60R15		1,0i (51 kW)/ 1,2i (60 kW)	
	4x100x54 ET 35				
	€ 71,90			Ab EGBE: e11*2001/116*0238*11 165/60R15 nur zulässig wenn werkseitig mit 15"-Bereifung ausgerüstet.	
RDKS					



C2		11/03-	J HFX, J KFV, J 8HX		
Stahl	PS 514022	6215	143657	Schrägheck	
	5½ J x14 H2	165/70R14 175/65R14		1,1 (44 kW)/ 1,4 (54 kW)/ 1,4 Hdi (50 kW)	
	4x108x65 ET 24				
	€ 54,40	Kegel sw 17 M12 x 1,25 x 26			
RDKS					

C2		11/03-	J KFV, J NFU, J 8HX		
Stahl	PS 515037	8690	154556	Schrägheck	
	6 J x15 H2	185/55R15		1,4 (54 kW)/ 1,6 (80 kW)/ 1,4 Hdi (50 kW)	
	4x108x65 ET 27				
	€ 67,10	Kegel sw 17 M12 x 1,25 x 26			
RDKS					



C3		04/02-09/09	F HFX, F KFV, F KFU, F 8HX, F 8HZ		
Stahl	PS 514022	6215	143657	Schrägheck	
	5½ J x14 H2	165/70R14		1,1i (44 kW)/ 1,4i (54 kW)/ 1,4 HDi (50 kW)	
	4x108x65	175/65R14		1,1i (44 kW)/ 1,4i (54/65 kW)/ 1,4 HDi (50 kW)/ 1,4 bivalent (54/49 kW)	
	ET 24				
	€ 54,40	Kegel sw 17 M12 x 1,25 x 26		FZG-Schein beachten: Je nach Ausführung unterschiedliche Reifenabmessungen vorgeschrieben!	
RDKS					





F KFV, F KFU, F NFU, F 8HX, F 8HY, F 8HZ, F 9HZ		04/02-09/09		C3
	Schrägheck	154556	8690	PS 515037
	1,4i (54/65 kW)/ 1,6i-16V (80 kW)/ 1,4i HDi (50/ 66 kW)/ 1,6 HDi (80 kW)/ 1,4 bilevant (54/49 kW)	185/60R15		6 J x15 H2 4x108x65 ET 27
		Kegel sw 17 M12 x 1,25 x 26		€ 67,10
RDKS				

S	10/09-	C3 II		
	Schrägheck	154560	8055	PS 515045
	1,1i (44 kW)/ 1,4i (54 kW)/VTi 95 (70 kW)/VTi 120 (88 kW)/ Hdi 90 (68 kW)/ HDi 110 (82 kW)	185/65R15		6 J x15 H2 4x108x65 ET 23
		Kegel sw 17 M12 x 1,25 x 26		€ 67,10
RDKS				



S, SH		C3 II / C3 Picasso			
		lichtsilber-lackiert / mattschwarz-lackiert		Interio	
				IN 605 25 4 08	
IN		C3 Picasso Typ SH nur Bereifung 195/60R15	ABE	185/65R15	6 J x15 H2 4 x 108 ET 25
			ABE	195/60R15	
			ABE	205/60R15	
MK 102		ASC; ASS; CUS; Huf 2.4; Huf 3.4; SE1C1; SE1C2; SE1S; TTC; TTS			
RDKS					

S	10/09-	C3 II		
	Schrägheck	163371	9493	PS 516018
	1,1i (44 kW)/ 1,4i (54 kW)/VTi 95 (70 kW)/VTi 120 (88 kW)/ Hdi 90 (68 kW)/ HDi 110 (82 kW)	195/55R16		6 J x16 H2 4x108x65 ET 23
		Kegel sw 17 M12 x 1,25 x 26		€ 76,60
RDKS				



S, SH		C3 II / C3 Picasso		
		lichtsilber-lackiert		Celsio
				CS 656 26 4 08
CS		lichtsilber-lackiert / mattschwarz-lackiert		Tezzo
				TZ 656 26 4 08
		ABE	195/55R16	6½ J x16 H2 4 x 108 ET 26
MK 102		Celsio: ASC; ASS; CUC; Huf 2.4; Huf 3.4; Huf 3.5; SE1C1; SE1C2; SE1S; TTC; TTS Tezzo: ASC; ASS; CUC; Huf 2.4; Huf 3.4; Huf 3.5; SE1C1; SE1C2; SE1S; TTC		
RDKS				

C3 Picasso			03/09-	SH	
Renner	PS 515045	8055	154560	Mini-Van	
	6 J x15 H2 4x108x65 ET 23	195/60R15		VTi 95 (70 kW)	
	€ 67,10	Kegel sw 17 M12 x 1,25 x 26			
RDKS	ASC; ASS; CUC; Huf 2.4; Huf 3.4; Huf 3.5; SE1C1; SE1C2; SE2C1; SE2C2; SE1S; SE2S; TTC				
C3 Picasso			03/09-	SH	
Stahl	PS 516018	9493	163371	Mini-Van	
	6 J x16 H2 4x108x65 ET 23	195/55R16		VTi 95 (70 kW)/VTi 120 (88 kW) / HDi 110 (80 kW)	
	€ 76,60	Kegel sw 17 M12 x 1,25 x 26			
RDKS	ASC; ASS; CUC; CUS; Huf 2.4; Huf 3.4; Huf 3.5; SE1C1; SE2C2; SE1S; SE2S; TTC; TTS				
C3 Pluriel			06/03-	H	
Stahl	PS 515037	8690	154556	Cabrio	
	6 J x15 H2 4x108x65 ET 27	185/65R15		1,4i (54 kW) / 1,6i-16V (80 kW)	
	€ 67,10	Kegel sw 17 M12 x 1,25 x 26			
RDKS					
C4			10/04-02/11	L	
Stahl	PS 515037	8690	154556	Limousine, Coupé	
	6 J x15 H2 4x108x65 ET 27	195/65R15		1,4i 16V (65 kW) / 1,6i 16 V (80 kW) / HDi 90 (66 kW)	
	€ 67,10	Kegel sw 17 M12 x 1,25 x 26			
RDKS					
C4			10/04-02/11	L	
Stahl	PS 516011	8565	163361	Limousine, Coupé	
	6½ J x16 H2 4x108x65 ET 26	205/55R16		1,4i 16 V (65 kW) / 1,6i 16 V (80 kW) / 2,0i 16V VTR (100 kW) / 2,0i 16V VTS (130 kW) / HDi 90 (66 kW) / HDi 110 (80 kW) / HDi 135 (100/103 kW)	
	€ 78,20	Kegel sw 17 M12 x 1,25 x 26			
RDKS					



		N		03/11-	C4 II
	Limousine	155201	7815	PS 515048	Stahl
	1,4i (70 kW)/ 1,6i (88 kW)/ 1,6 HDi (68/82 kW)	195/65R15		6½ J x15 H2 4x108x65 ET 27	
		Kegel sw 17 M12 x 1,25 x 26		€ 67,60	RDKS
ASC; ASS; CUC; CUS; Huf 2.4; Huf 3.4; Huf 3.5; SE1C1; SE1C2; SE2C1; SE2C2; SE1S; SE2S; TTC; TTS / OE: Schrader 3000					

		N		C4 II	
		lichtsilber-lackiert / mattschwarz-lackiert		Tezzo	TZ 655 24 4 08
				6½ J x15 H2 4 x 108 ET 24	MAGMA
TZ	TZ	ABE	195/65R15 ❄	RDKS	
		ABE	205/60R15 ❄	RDKS	
MK 111		ASC; ASS; CUC; Huf 2.4; Huf 3.4; Huf 3.5; SE1C1; SE1C2; SE1S; TTC / OE: Schrader 3000			

		N		03/11-	C4 II
	Limousine	163367	9337	PS 516016	Stahl
	1,4i (70 kW)/ 1,6i (88/115 kW)/ 1,6 HDi (68/82 kW)/ 2,0 HDi (110 kW)	205/55R16		7 J x16 H2 4x108x65 ET 32	
		Kegel sw 17 M12 x 1,25 x 26		€ 78,20	RDKS
ASC; ASS; CUC; CUS; Huf 2.4; Huf 3.4; Huf 3.5; SE1C1; SE1C2; SE2C1; SE2C2; SE1S; SE2S; TTC / OE: Schrader 3000					

		N		C4 II	
		lichtsilber-lackiert		Celsio	CS 656 26 4 08
		lichtsilber-lackiert / mattschwarz-lackiert		Tezzo	TZ 656 26 4 08
				6½ J x16 H2 4 x 108 ET 26	MAGMA
CS	TZ	ABE	195/55R16 ❄	RDKS	
		ABE	195/60R16 ❄	RDKS	
MK 111		Celsio; ASC; ASS; CUC; Huf 2.4; Huf 3.4; Huf 3.5; SE1C1; SE1C2; SE1S; TTC; TTS / OE: Schrader 3000 Tezzo; ASC; ASS; CUC; Huf 2.4; Huf 3.4; Huf 3.5; SE1C1; SE1C2; SE1S; TTC / OE: Schrader 3000			

		B		06/12-	C4 Aircross
	SUV	163339	9657	PS 516020	Stahl
	1,6i (86 kW)/ 1,6D (84 kW)/ 1,8 D (110 kW)	215/70R16		6½ J x16 CH 5x114,3x67 ET 38	
		Kegel sw 21 M12 x 1,5		€ 90,90	RDKS
ASC; ASS; CUC; Huf 2.4; Huf 3.4; Huf 3.5; SE1C1; SE1C2; SE2C2; SE1S; SE2S; TTS / OE: VDO S180052094Z					

C4 Aircross				B		
MAGNA	Celsio	CS 656 40 5 14	lichtsilber-lackiert			
	Tezzo	TZ 656 40 5 14	lichtsilber-lackiert / mattschwarz-lackiert			
	6½ J x16 H2	215/70R16	ABE			
	5 x 114,3					
ET 40						
RDKS	Celsio: ASC; ASS; CUC; Huf 2.4; Huf 3.4; Huf 3.5; SE1C1; SE1C2; SE15; TTC; TTS Tezzo: ASC; ASS; CUC; Huf 2.4; Huf 3.4; Huf 3.5; SE1C1; SE1C2; SE15; TTC / OE-VDD S180052094Z			MK 047	CS	TZ



C4 Cactus			09/14-	0	
Stahl	PS 515052	7385	154548	SUV	
	6½ J x15 H2	195/65R15		1,2i (55/60 kW) / 1,6 HDi (68/73 kW)	
	4x108x65				
	ET 20				
	€ 71,90				
RDKS					

C4 Cactus				0		
MAGNA	Interio	IN 605 25 4 08	lichtsilber-lackiert / mattschwarz-lackiert			
	6 J x15 H2	195/60R15M+S	⊗	ABE		
	4 x 108	195/65R15M+S	⊗	ABE		
	ET 25	205/60R15M+S		ABE		
RDKS	ASC; ASS; CUS; Huf 2.4; Huf 3.4; Huf 3.5; SE1C1; SE1C2; SE15; TTC; TTS			MK 102	IN	IN

C4 Cactus			09/14-	0	
Stahl	PS 516021	9432	163344	SUV	
	6½ J x16 H2	205/55R16		1,2i (55/60 kW) / 1,6 HDi (68/73 kW)	
	4x108x65				
	ET 20				
	€ 77,10				
RDKS	ASC; ASS; CUC; CUS; Huf 2.4; Huf 3.4; Huf 3.5; SE15; SE25; TTC; TTS				

C4 Picasso / Grand C4 Picasso			10/06-05/13	U	
Stahl	PS 515047		154555	Mini-Van	
	6½ J x15 H2	205/65R15		1,6i (88 kW) / 1.8 16V (92 kW) / 1.6 HDi 110 FAP (80 kW)	
	4x108x65				
	ET 27				
	€ 66,40	Kegel sw 17 M12 x 1,25 x 26			
RDKS					

		U	10/06-05/13	C4 Picasso / Grand C4 Picasso	
	Mini-Van		163364	7860	PS 516012
	1,6i (88 kW)/ 1.8 16V (92 kW)/ 2.0 16V (103 kW)/ 1.6 HDi 110FAP (80 kW)/ 2.0 HDi 135 FAP (100 kW)		215/55R16		6½ J x16 H2 4x108x65 ET 26
			Kegel sw 17 M12 x 1,25 x 26		€ 77,10
RDKS					

		U	C4 Picasso / Grand C4 Picasso				
	IN		Achlasten beachten	lichtsilber-lackiert / mattschwarz-lackiert		Interio	IN 706 26 4 08
				ABE	205/55R16	7 J x16 EH2+ 4 x 108 ET 26	
				ABE	205/60R16		
				ABE	215/55R16		
				MK 102		ASC; CUC; Huf 2.4; Huf 3.4; Huf 3.5; SE1C1; SE1S	
RDKS							

		3	06/13-	C4 Picasso / Grand C4 Picasso	
	Mini-Van		163375	9253	PS 516022
	1,6i (88/115 kW)/ 1,6 HDi (68/85 kW)		205/60R16		6½ J x16 H2 5x108x65 ET 47
			Kegel sw 17 M12 x 1,25 x 26		€ 77,10
RDKS					

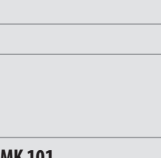
		3	C4 Picasso / Grand C4 Picasso						
	CS		Achlasten beachten	lichtsilber-lackiert		Celsio	CS 707 47 5 08		
				ABE	205/55R17	7 J x17 EH2+ 5 x108 ET 47			
				ABE	225/50R17				
				MK 101			ASC; ASS; CUC; CUS; Huf 2.4; Huf 3.4; Huf 3.5; SE1C1; SE1C2; SE1S; TTC		
				RDKS					



		R 6FZ, R RFJ, R 9HZ, R RHR	10/04-03/08	C5	
	Stufenheck, Kombi		163361	8565	PS 516011
	1,8 16V (85 kW)/ 2,0 16V (103 kW)/ HDI 110 FAP (80 kW)/ HDI 135 FAP (100 kW)		215/55R16		6½ J x16 H2 4x108x65 ET 26
	Nur für Facelift 10/04-03/08, nicht 3,0 V6 (152 kW) ACHTUNG: 4-LOCH!		Kegel sw 17 M12 x 1,25 x 26		€ 78,20
RDKS					

C5			04/08-	R	
Stahl	PS 516014	9277	163370	Stufenheck, Kombi	
	7 J x16 H2	225/60R16		1,6 16V (115 kW) / 1,8 16V (92 kW) / 2,0i (103 kW)	
	5x108x65			Hdi 110 (80 kW) / Hdi 135 (100 kW) / Hdi 165 (120 kW)	
	ET 32				
	€ 79,20	Kegel sw 17 M12 x 1,25 x 26		ACHTUNG: 5-LOCH!	
RDKS	ASC; ASS; CUC; CUS; Huf 2.4; Huf 3.4; Huf 3.5; SE1C1; SE1C2; SE2C1; SE2C2; SE1S; SE2S; TTC / OE: Schrader 3002				

C5			04/08-	R	
Stahl	PS 517002	8255	175360	Stufenheck, Kombi	
	7 J x17 H2	225/55R17		1,6 16V (115 kW) / 1,8 16V (92 kW) / 2,0i (103 kW) / THP 155 (155 kW)	
	5x108x65			Hdi 110 (80 kW) / Hdi 135 (100 kW) / Hdi 165 (120 kW)	
	ET 32				
	€ 98,30	Kegel sw 17 M12 x 1,25 x 26		ACHTUNG: 5-LOCH!	
RDKS	ASS; CUS; Huf 3.5; SE1C1; SE1C2; SE2C1; SE2C2; SE1S; SE2S / OE: Schrader 3002				

C6			11/05-12/12	T	
Stahl	PS 517002	8255	175360	Stufenheck	
	7 J x17 H2	225/55R17		3,0 V6 / 2,2 Hdi / 2,7 Hdi	
	5x108x65				
	ET 32				
	€ 98,30	Kegel sw 17 M12 x 1,25 x 26			
RDKS	ASS; CUS; Huf 3.5; SE1C1; SE1C2; SE2C1; SE2C2; SE1S; SE2S				

C-Crosser			09/07-	V	
Stahl	MT 516003	9407	163401	SUV	
	6½ JJ x16 CH	215/70R16		2,4i (125 kW) / 2,2 Hdi 155 FAP	
	5x114,3x67				
	ET 38				
	€ 90,90	Kegel sw 21 M12 x 1,5			
RDKS	ASC; ASS; CUC; Huf 2.4; Huf 3.4; Huf 3.5; SE1C1; SE1C2; SE2C2; SE1S; SE2S				

C-Crosser				V		
KRONPRINZ MAGNA	Tezzo	TZ 656 40 5 14		lichtsilber-lackiert / mattschwarz-lackiert		
	6½ J x16 H2	215/70R16	ABE			
	5 x 114,3					
	ET 40					
RDKS	ASC; ASS; CUC; Huf 2.4; Huf 3.4; Huf 3.5; SE1C1; SE1C2; SE1S; TTC			MK 047	TZ	TZ



		1	01/11-	C-Zero	
	Schrägheck	154537	7160	PS 515049	
	Elektro (35 kW)	145/65R15		4 J x15 H2 4x100x56 ET 35	
	Nur für die Vorderachse zulässig!	Kegel sw 21 M12 x 1,5		€ 82,90	
RDKS					

		1	01/11-	C-Zero	
	Schrägheck	154538	7235	PS 515050	
	Elektro (35 kW)	175/55R15		5 J x15 H2 4x100x54 ET 35	
	Nur für die Hinterachse zulässig!	Kegel sw 21 M12 x 1,5		€ 82,90	
ASC; ASS; CUC; CUS; Huf 2.4; Huf 3.4; Huf 3.5; SE1S; TTC					
RDKS					

		S	03/10-	DS3	
	Schrägheck	154560	8055	PS 515045	
	VTi 95 (70 kW)/VTi 120 (88 kW)/ HDi 90 (68 kW)/ HDi 110 (82 kW)	185/65R15		6 J x15 H2 4x108x65 ET 23	
		Kegel sw 17 M12 x 1,25 x 26		€ 67,10	
ASC; ASS; CUC; CUS; Huf 2.4; Huf 3.4; Huf 3.5; SE1C1; SE1C2; SE2C1; SE2C2; SE1S; SE2S; TTC					
RDKS					

		S	DS3			
		lichtsilber-lackiert / mattschwarz-lackiert		Interio IN 605 25 4 08		
			ABE	185/65R15	6 J x15 H2	
			ABE	195/60R15	4 x 108	
			ABE	205/60R15	ET 25	
IN	IN	MK 102	ASC; ASS; CUS; Huf 2.4; Huf 3.4; SE1C1; SE1C2; SE1S; TTC; TTS			
RDKS						

		S	03/10-	DS3	
	Schrägheck, Cabrio	163371	9493	PS 516018	
	VTi 95 (70 kW)/VTi 120 (88 kW)/THP 150 (115 kW)/ HDi 90 (68 kW)/ HDi 110 (82 kW)	195/55R16		6 J x16 H2 4x108x65 ET 23	
		Kegel sw 17 M12 x 1,25 x 26		€ 76,60	
ASC; ASS; CUC; CUS; Huf 2.4; Huf 3.4; Huf 3.5; SE1C1; SE2C2; SE1S; SE2S; TTC; TTS					
RDKS					





DS3				S		
KRONPRINZ MAGNA	Interio		IN 706 26 4 08	lichtsilber-lackiert / matschwarz-lackiert		
	7 J x16 EH2+	185/55R16	ABE			
	4 x 108	195/50R16	ABE			
	ET 26	195/55R16	ABE			
RDKS	ASC; CUC; Huf 2.4; Huf 3.4; Huf 3.5; SE1C1; SE1S			MK 102	IN	IN





DS4			07/11-	N		
Stahl	PS 516016	9337	163367	Limousine		
	7 J x16 H2	215/60R16		1,6i (88/115 kW)/ 1,6 HDi (82 kW)/ 2,0 HDi (120 kW)		
	4x108x65					
	ET 32					
	€ 78,20	Kegel sw 17 M12 x 1,25 x 26		Nicht zulässig für 1,6i (147 kW)!		
RDKS	ASC; ASS; CUC; CUS; Huf 2.4; Huf 3.4; Huf 3.5; SE1C1; SE1C2; SE2C1; SE2C2; SE1S; SE2S; TTC / OE: Schrader 3002					

DS4				N		
KRONPRINZ MAGNA	Interio		IN 706 26 4 08	lichtsilber-lackiert / matschwarz-lackiert		
	7 J x16 EH2+	215/55R16	⊛	ABE		
	4 x 108	215/60R16	⊛	ABE		
	ET 26					
RDKS	ASC; CUC; Huf 2.4; Huf 3.4; Huf 3.5; SE1C1; SE1S			MK 111	IN	IN

DS5				K	
KRONPRINZ MAGNA	Celsio		CS 656 26 4 08	lichtsilber-lackiert	
	6½ J x16 H2	215/55R16	⊛	ABE	
	4 x 108	215/60R16	⊛	ABE	
	ET 26	225/55R16	⊛	ABE	
RDKS	ASC; ASS; CUC; Huf 2.4; Huf 3.4; Huf 3.5; SE1C1; SE1C2; SE1S; TTC; TTS / OE: Schrader 3002			MK 111	CS

Jumper			03/94-03/02	23, 230, 230 D, 230 L, 230 P	
Stahl	*FL 615001	8875	154582	Bus, Kasten, Pritsche	
	6 J x15 H2	195/70R15		2,0i/1,9D/1,9TD/2,5D/2,5TD/2,8 HDI	
	5x118x71,1	205/70R15			
	ET 68				
	€ 94,00	Kegel sw 24 M14 x 1,5 x 28		FZG-Schein muss unbedingt beachtet werden: Je nach Ausführung und Motorisierung sind unterschiedliche Reifenabmessungen vorgeschrieben. Bei einigen Ausführungen ist ausschließlich 16 Zoll zulässig.	
RDKS					

230, 230 D, 230 L, 230 P		03/94-03/02	Jumper		
	Bus, Kasten, Pritsche	163380	9600	*FL 616002	Stahl
	2,0i/2,5D/2,5TD/2,8 HDI	205/75R16		6 J x16 H2	
		215/75R16		5x130x78,1 ET 68	
	FZG-Schein muss unbedingt beachtet werden: Je nach Ausführung und Motorisierung sind unterschiedliche Reifenabmessungen vorgeschrieben. Bei einigen Ausführungen ist ausschließlich 15 Zoll zulässig.	Kegel sw 24 M16 x 1,5 x 31		€ 107,80	RDKS
Z, 244, 244 D, 244 L, 244 M		04/02-05/06	Jumper		
	Bus, Kasten, Pritsche	154582	8875	*FL 615001	Stahl
	2,0i/ 2,0 HDI/ 2,2 HDI/ 2,8 HDI/ 2,0 Bipower	195/70R15		6 J x15 H2	
		205/70R15		5x118x71,1 ET 68	
	FZG-Schein muss unbedingt beachtet werden: Je nach Ausführung und Motorisierung sind unterschiedliche Reifenabmessungen vorgeschrieben. Bei einigen Ausführungen ist ausschließlich 16 Zoll zulässig.	Kegel sw 24 M14 x 1,5 x 28		€ 94,00	RDKS
244, 244 D, 244 L, 244 M		04/02-05/06	Jumper		
	Bus, Kasten, Pritsche	163380	9600	*FL 616002	Stahl
	2,0i/ 2,0 HDI/ 2,2 HDI/ 2,8 HDI/ 2,0 Bipower	205/75R16		6 J x16 H2	
		215/75R16		5x130x78,1 ET 68	
	FZG-Schein muss unbedingt beachtet werden: Je nach Ausführung und Motorisierung sind unterschiedliche Reifenabmessungen vorgeschrieben. Bei einigen Ausführungen ist ausschließlich 15 Zoll zulässig.	Kegel sw 24 M16 x 1,5 x 31		€ 107,80	RDKS
250, 250 D, 250 L, Y, YB, YC		06/06-04/14	Jumper		
	Bus, Kasten, Pritsche	154590	8877	*FL 615002	Stahl
	Hdi 100 (74 kW)/ Hdi 110 (110 kW)/ Hdi 120 (88 kW)/	205/70R15		6 J x15 H2	
	Hdi 130 (96 kW)/ Hdi 150 (110 kW)/ Hdi 160 (116 kW)/	215/70R15		5x118x71,1	
Hdi 180 (130 kW)	225/70R15		ET 68		
	FZG-Schein muss unbedingt beachtet werden: Je nach Ausführung und Motorisierung sind unterschiedliche Reifenabmessungen vorgeschrieben.	Kegel sw 21 M14 x 1,5 x 27		€ 94,00	RDKS
250, 250 D, 250 L, Y, YB, YC		06/06-04/14	Jumper		
	Bus, Kasten, Pritsche	154547	4011	FL 615007	Stahl
	Hdi 100 (74 kW)/ Hdi 110 (110 kW)/ Hdi 120 (88 kW)/	205/70R15		6 J x15 H2	
	Hdi 130 (96 kW)/ Hdi 150 (110 kW)/ Hdi 160 (116 kW)/	215/70R15		5x118x71,1	
Hdi 180 (130 kW)	225/70R15		ET 68		
	FZG-Schein muss unbedingt beachtet werden: Je nach Ausführung und Motorisierung sind unterschiedliche Reifenabmessungen vorgeschrieben.	Kegel sw 21 M14 x 1,5 x 27		€ 94,00	RDKS
	Eersetzt FL 615002. TPMS modifiziertes Rad.				

Jumper			05/14-	Y	
Stahl	FL 615007	4011	154547	Bus, Kasten, Pritsche	
	6 J x15 H2	215/70R15		Hdi 110 (81 kW)/ Hdi 130 (96 kW)/ Hdi 150 (110 kW)/ Hdi 180 (130 kW)	
	5x118x71,1 ET 68	225/70R15			
	€ 94,00			MJ 2014.	
RDKS	ASC; ASS; CUC; Huf 3.5; SE1C1; SE1C2; SE2C1; SE2C2; SE1S; SE2S; TTC; TTS / OE: Schrader 3002			FZG-Schein muss unbedingt beachtet werden: Je nach Ausführung und Motorisierung sind unterschiedliche Reifenabmessungen vorgeschrieben.	
Jumper			10/14-	Y	
Stahl	FL 616008		163396	Bus, Kasten, Pritsche	
	6 J x16 H2	215/75R16		Hdi 110 (81 kW)/ Hdi 130 (96 kW)/ Hdi 150 (110 kW)/ Hdi 180 (130 kW)	
	5x118x71,1 ET 68	225/75R16			
	€ 107,80			FZG-Schein muss unbedingt beachtet werden: Je nach Ausführung und Motorisierung sind unterschiedliche Reifenabmessungen vorgeschrieben.	
RDKS					
Jumper (Heavy)			10/14-	Y	
Stahl	FL 616009	7011	163397	Bus, Kasten, Pritsche	
	6 J x16 H2	215/75R16		Hdi 110 (81 kW)/ Hdi 130 (96 kW)/ Hdi 150 (110 kW)/ Hdi 180 (130 kW)	
	5x130x78,1 ET 68	225/75R16			
	€ 107,80			FZG-Schein muss unbedingt beachtet werden: Je nach Ausführung und Motorisierung sind unterschiedliche Reifenabmessungen vorgeschrieben.	
RDKS	OE: Schrader 3002				
Jumper			06/06-04/14	250, 250 B, 250 D, 250 L, Y, YD	
Stahl	FL 616004	9601	163381	Bus, Kasten, Pritsche	
	6 J x16 H2	215/75R16		Hdi 120 (88 kW)/ Hdi 130 (96 kW)/ Hdi 150 (110 kW)/ Hdi 160 (116 kW)/ Hdi 180 (130 kW)	
	5x130x78,1 ET 68	225/75R16			
	€ 107,80	Kegel sw 21 M16 x 1,5 x 29		FZG-Schein muss unbedingt beachtet werden: Je nach Ausführung und Motorisierung sind unterschiedliche Reifenabmessungen vorgeschrieben.	
RDKS					
Jumpy			10/06-	G9	
Stahl	PS 615002	7670	154559	Kasten	
	6½ J x15 H2	215/65R15		1,6 Hdi 90 (66 kW)/ 2,0 Hdi 120 (88 kW)/ 2,0 Hdi 135 FAP (100 kW)	
	5x108x65 ET 38				
	€ 84,50	Kegel sw 19 M14 x 1,5 x 25		Bei einigen Ausführungen ist ausschließlich 16 Zoll zulässig.	
RDKS	ASC; ASS; CUC; CUS; Huf 2.4; Huf 3.4; Huf 3.5; SE1C1; SE1C2; SE2C1; SE2C2; SE1S; SE2S; TTC / OE: Schrader 3003				

		G9	10/06-	Jumpy	
	Kasten	163363	7780	PS 616001	Stahl
	2,0 16V (103 kW)/ 1,6 HDi 90 (66 kW)/ 2,0 HDi 120 (88 kW)/ 2,0 HDi 135 FAP (100 kW)	215/60R16		7 J x16 H2 5x108x65 ET 42	
		Kegel sw 19 M14 x 1,5 x 25		€ 90,90	RDKS
		ASC; ASS; CUC; CUS; Huf 2.4; Huf 3.4; Huf 3.5; SE1C1; SE1C2; SE2C1; SE2C2; SE1S; SE2S; TTC; TTS / OE: Schrader 3003			
		X	10/06-	Jumpy	
	Kombi	163363	7780	PS 616001	Stahl
	2,0 16V (103 kW)/ 1,6 HDi 90 (66 kW)/ 2,0 HDi 120 (88 kW)/ 2,0 HDi 135 FAP (100 kW)	215/60R16		7 J x16 H2 5x108x65 ET 42	
		Kegel sw 19 M14 x 1,5 x 25		€ 90,90	RDKS
		ASC; ASS; CUC; CUS; Huf 2.4; Huf 3.4; Huf 3.5; SE1C1; SE1C2; SE2C1; SE2C2; SE1S; SE2S; TTC; TTS / OE: Schrader 3003			
		225L	02/08-	Nemo	
	Kasten	143695	6805	FL 614004	Stahl
	1,4i (54 kW)/ HDi 70 (50 kW)	175/70R14		5½ J x14 H2 4x98x58 ET 44	
		Kegel sw 17 M12 x 1,25 x 26		€ 58,10	RDKS
		ASC; ASS; Huf 2.4; Huf 3.5; SE2S / OE: Schrader 3016			
		225L	02/08-	Nemo	
	Kasten	154594	7680	FL 515013	Stahl
	1,4i (54 kW)/ HDi 70 (50 kW)	185/65R15		6 J x15 H2 4x98x58 ET 44	
		Kegel sw 17 M12 x 1,25 x 26		€ 66,60	RDKS
		ASC; ASS; CUC; CUS; Huf 2.4; Huf 3.4; SE1C1; SE1C2; SE1S; TTC; TTS / OE: Schrader 3016			
		A	07/08-	Nemo Combi	
	Kombi	154594	7680	FL 515013	Stahl
	1,4i (54 kW)/ HDi 70 (50 kW)	185/65R15		6 J x15 H2 4x98x58 ET 44	
		Kegel sw 17 M12 x 1,25 x 26		€ 66,60	RDKS
		ASC; ASS; CUC; CUS; Huf 2.4; Huf 3.4; SE1C1; SE1C2; SE1S; TTC; TTS / OE: Schrader 3016			

Xsara			09/97-09/04	N6	
Stahl	PS 515022	8470	154554	Coupé	
	6 J x15 H2 4x108x65 ET 18	195/55R15		2,0i (120 kW)	
	€ 67,10	Kegel sw 19 M12 x 1,25 x 26		Ab Baujahr 09/02- Radschraube: Kegel sw 17 M12 x 1,25 x 26	
RDKS					

Xsara			10/00-09/04	N KFW, N NFU, N RHY, N RFN, N RHZ, N WJY	
Stahl	PS 515022	8470	154554	Schrägheck, Kombi, Coupé	
	6 J x15 H2 4x108x65 ET 18	195/55R15		1,4 SX/1,6 SX/1,6 16V SX/1,6 16V VTR/ 1,8 16V SX/2,0 HDi VTR/ 2,0 16V Ex./ 1,8 HDi/1,9D SX/2,0 HDi SX	
	€ 67,10	Kegel sw 19 M12 x 1,25 x 26		Ab Baujahr 09/02- Radschraube: Kegel sw 17 M12 x 1,25 x 26	
RDKS					

Xsara Picasso			02/00-	C	
Stahl	PS 515039	8475	154557	Mini-Van	
	6 J x15 CH 4x108x65 ET 18	185/65R15		1,6i SX/ 1,8i-16V SX/ 2,0-16V/ 2,0 HDi SX	
	€ 67,10	Kegel sw 19 M12 x 1,25 x 26		Ab Baujahr 09/02- Radschraube: Kegel sw 17 M12 x 1,25 x 26	
RDKS					

DACIA

Dokker			03/13-	SD	
Stahl	RE 515029	7775	154539	Kombi, Kasten	
	6 J x15 H2 4x100x60 ET 40	185/65R15		1,6 MPI (61 kW)/TcE 115 (85 kW)/ dCi 75 (55 kW)/ dCi 90 (66 kW)	
	€ 71,50	Kegel sw 17 M12 x 1,5 x 26			
RDKS			ASC; ASS; CUC; SE1C1; SE1C2; SE1S / OE: Schrader 3041		

SD		04/10-	Duster	
	SUV	163347	8873	RE 516018
	1,2i (92 kW)/ 1,6i-16V (77 kW)/ 1,6i-16V LPG (77 kW)/ dCi 80 (63 kW)/ dCi 90 (66 kW)/ dCi 110 (79/81 kW)/ 4x2/ 4x4	215/65R16		6½ J x16 H2 5x114,3x66 ET 50
		Kegel sw 17 M12 x 1,5 x 26		€ 79,80
		ASC; ASS; CUC; CUS; Huf 2.4; Huf 3.4; Huf 3.5; SE1C1; SE1C2; SE2C2; SE1S; TTC/ OE: Schrader 3041		RDKS

SD, SR		Duster		
	CS	lichtsilber-lackiert		Celsio
				CS 656 50 5 14
		ABE	215/65R16 ❄	6½ J x16 H2 5 x 114,3 ET 50
		ABE	225/60R16 ❄	
ABE	235/60R16			
	MK 217	ASC; ASS; CUC; Huf 2.4; Huf 3.4; Huf 3.5; SE1C1; SE1C2; SE1S; TTC; TTS / OE: Schrader 3041		RDKS

MAGMA

SD		06/12-	Lodgy	
	Van	154539	7775	RE 515029
	1,2 TCe (85 kW)/1,6 MPI (61 kW)/ dCi 90 (66 kW)/ dCi 110 (79 kW)	185/65R15		6 J x15 H2 4x100x60 ET 40
		Kegel sw 17 M12 x 1,5 x 26		€ 71,50
		ASC; ASS; CUC; SE1C1; SE1C2; SE1S / OE: Schrader 3041		RDKS

SD		06/05-07/10	Logan	
	Stufenheck	143673	5995	RE 514018
	1,4 MPI (55 kW)/ 1,6 MPI (64 kW)/ 1,5 dCi (50 kW)	165/80R14	185/70R14	5½ J x14 H2 4x100x60
	1,6 16V (77 kW)	185/70R14		ET 43
	Einige Fahrzeugausführungen nur 15 Zoll. Einige Fahrzeugausführungen nur 185/70R14.	Kegel sw 17 M12 x 1,5 x 26		€ 60,20
				RDKS

SD		06/05-07/10	Logan	
	Stufenheck	154573	7965	RE 515021
	1,4 MPI (55 kW)/ 1,6 MPI (64 kW)/ 1,6 16V (77 kW)/ 1,5 dCi (50/63 kW)	185/65R15		6 J x15 H2 4x100x60 ET 50
		Kegel sw 17 M12 x 1,5 x 26		€ 74,50
				RDKS

Renner



Logan Express			06/09-	FSD/USD	
Renner	RE 515021	7965	154573	Kasten	
	6 J x15 H2 4x100x60 ET 50	185/65R15		1,4 MPI (55 kW)/ 1,6 MPI (64 kW)/ 1,5 dCi (50/63 kW)	
	€ 74,50	Kegel sw 17 M12 x 1,5 x 26			
RDKS					

Logan MCV			01/07-07/13	SD	
Stahl	RE 514018	5995	143673	Kombi	
	5½ J x14 H2 4x100x60 ET 43	185/70R14		1,4 MPI (55 kW)/ 1,6 MPI (62/64 kW)/ 1,6 16V (77 kW)/ 1,5 dCi (50/63/65 kW)/ 1,6MPI LPG (62 kW)	
	€ 60,20	Kegel sw 17 M12 x 1,5 x 26		Einige Fahrzeugausführungen nur 15 Zoll.	
RDKS					

Logan MCV			01/07-07/13	SD	
Renner	RE 515021	7965	154573	Kombi	
	6 J x15 H2 4x100x60 ET 50	185/65R15		1,4 MPI (55 kW)/ 1,6 MPI (62/64 kW)/ 1,6 16V (77 kW)/ 1,5 dCi (50/63/65 kW)/ 1,6MPI LPG (62 kW)	
	€ 74,50	Kegel sw 17 M12 x 1,5 x 26			
RDKS					

Logan MCV			08/13-	SD	
Stahl	RE 515031	8932	154549	Kombi	
	6 J x15 H2 4x100x60 ET 40	185/65R15		1,2i (55 kW)/ 1,2 LPG (55 kW)/ TCe 90 (66 kW)/ dCi 90 (66 kW)	
	€ 71,50	Kegel sw 17 M12 x 1,5 x 26			
RDKS	ASC; ASS; CUC; CUS; Huf 2.4; Huf 3.4; Huf 3.5; SE1C1; SE1C2; SE2C2; SE1S; SE2S; TTC; TTS / OE: Schrader 3041				

Sandero			06/08-12/12	SD	
Stahl	RE 514018	5995	143673	Schrägheck	
	5½ J x14 H2 4x100x60 ET 43	165/80R14		1,2-16V (55 kW)/ 1,4 MPI (55 kW)/ 1,6 MPI (62/64 kW)/ 1,5 dCi (50 kW)	
	€ 60,20	Kegel sw 17 M12 x 1,5 x 26			
RDKS					

SD		06/08-12/12	Sandero	
	Schrägheck	154573	7965	RE 515021
	1,2-16V (55 kW)/ 1,4 MPI (55 kW)/ 1,6 MPI (62/64 kW)/ 1,5 dCi (50/55/63/65 kW)/ 1,2-16V LPG (55 kW)/ 1,4 MPI LPG (53 kW)	185/65R15		6 J x15 H2 4x100x60 ET 50
	Einige Ausführungen nur 16 Zoll!	Kegel sw 17 M12 x 1,5 x 26		€ 74,50
RDKS				
SD		09/09-12/12	Sandero Stepway	
	SUV	154573	7965	RE 515021
	1,6 MPI (62/64 kW)/ 1,6 MPI LPG (62/64 kW)/ 1,6 16V (77 kW)/ 1,5 dCi (50/65 kW)	185/65R15		6 J x15 H2 4x100x60 ET 50
	Einige Ausführungen nur 16 Zoll!	Kegel sw 17 M12 x 1,5 x 26		€ 74,50
RDKS				
SD		01/13-	Sandero II	
	Schrägheck	154522	7777	RE 515027
	1,2 16V (55 kW)/ TCe 90 (66 kW)/ dCi 90 (66 kW)/ 1,2 16V LPG (55 kW)	185/65R15		6 J x15 H2 4x100x60 ET 40
	Einige Ausführungen nur 16 Zoll!	Kegel sw 17 M12 x 1,5 x 26		€ 74,50
ASC; ASS; CUC; Huf 2.4; Huf 3.4; Huf 3.5; SE1C1; SE1C2; SE2C1; SE2C2; SE15; SE25; TTC / OE: Schrader 3041				
RDKS				
SD		01/13-	Stepway II	
	SUV	154522	7777	RE 515027
	TCe 90 (66 kW)/ dCi 90 (66 kW)	185/65R15		6 J x15 H2 4x100x60 ET 40
	Einige Ausführungen nur 16 Zoll!	Kegel sw 17 M12 x 1,5 x 26		€ 74,50
ASC; ASS; CUC; Huf 2.4; Huf 3.4; Huf 3.5; SE1C1; SE1C2; SE2C1; SE2C2; SE15; SE25; TTC / OE: Schrader 3041				
RDKS				

Charade		05/11-01/13	XP9F(a)	
Stahl	TO 515011	7890	154668	Schrägheck
	5½ J x15 CH 4x100x54 ET 45	185/60R15		1,3i (73 kW)
	€ 72,40	Kegel sw 21 M12 x 1,5		
RDKS				
Cuore		09/03-06/07	L2	
Stahl	DA 513005	2430	133513	Schrägheck
	4.00 B x13 H2 4x100x54 ET 40	155/65R13		1,0 Plus (43 kW)
	€ 69,20	Kegel sw 21 M12 x 1,5/H17		Einige Ausführungen nur 14 Zoll.
RDKS				
Cuore		07/07-01/13	L27	
Stahl	DA 513005	2430	133513	Schrägheck
	4.00 B x13 H2 4x100x54 ET 40	145/80R13		1,0i (51 kW)
	€ 69,20	Kegel sw 21 M12 x 1,5/H17		
RDKS				
Trevis		09/06-01/13	L65	
Stahl	DA 513005	2430	133513	Schrägheck
	4.00 B x13 H2 4x100x54 ET 40	145/80R13	155/65R13	1,0i (43 kW)
	€ 69,20	Kegel sw 21 M12 x 1,5		
RDKS				

		JC	07/08-	Journey		
	Van	163326	9517	FL 516006		
	2,4i (125 kW)/ 2,8i (136 kW)/ 2,0 CRD (103 kW)	225/65R16		6½ J x16 H2 5x127x71,5 ET 40		
		Kegel sw 21 M12 x 1,5		€ 89,20		
		ASC; ASS; CUC; CUS; Huf 2.4; Huf 3.4; Huf 3.5; SE1C1; SE1C2; SE1S; TTC / OE: Schrader 3007				RDKS

Stahl



		312	09/07-	500 / 500C		
	Schrägheck, Cabrio	143694	6315	FL 514026		
	0,9i (63/77 kW)/ 1,2i 8V (51 kW)/ 1,4i 16V (74 kW)/ 1,3 D Multijet 16V (55/70 kW)	175/65R14		5½ J x14 H2 4x98x58 ET 35		
		Kegel sw 17 M12 x 1,25 x 22		€ 56,50		
		CUC; Huf 3.5; SE1C1; SE1C2; SE1S; SE2S / OE: Schrader 3016				RDKS

Renner

		312	500 / 500C		
		lichtsilber-lackiert	Celsio	CS 554 35 4 98	
			ABE	165/65R14 ❄	5½ J x14 H2
			ABE	175/65R14 ❄	
			ABE	185/60R14	ET 35
	CS	MK 109	ASC; ASS; Huf 2.4; Huf 3.4; SE1C1; SE1C2; SE1S; TTC; TTS		

MAGMA

RDKS

		312	500 / 500C			
			lichtsilber-lackiert / mattschwarz-lackiert	Seismo	SO 604 35 4 98	
				ABE	165/65R14 ❄	6 J x14 H2
				ABE	175/65R14	
				ABE	185/60R14	ET 35
		SO	MK 109	ASC; ASS; Huf 2.4; Huf 3.4; SE1C1; SE1C2; SE1S; TTC; TTS		

MAGMA

RDKS

500 / 500C			09/07-	312	
Stahl	FL 515009	8185	154589	Schrägheck, Cabrio	
	6 J x15 H2	185/55R15		0,9i (77 kW) / 1,4i 16V (74 kW)	
	4x98x58				
	ET 40				
	€ 74,00	Kegel sw 17 M12 x 1,25 x 22			
RDKS	ASC; ASS; CUC; Huf 2.4; Huf 3.4; SE1C1; SE1S; TTC; TTS / OE: Schrader 3016				



500 / 500C			312		
MAGNUM	Interio		IN 605 35 4 98	lichtsilber-lackiert / mattschwarz-lackiert	
	6 J x15 H2	185/55R15	ABE		
	4 x 98	195/50R15	ABE		
	ET 35				
RDKS	ASC; ASS; CUS; Huf 2.4; Huf 3.4; SE1C1; SE1C2; SE1S; TTC; TTS			MK 109	IN

500 L			10/12-	199	
Stahl	FL 515024	8737	154603	Mini-Van	
	6 J x15 H2	195/65R15		0,9 TwinAir (77 kW) / 1,3 Multijet (62 kW) / 1,4i 16V (70 kW) / 1,6 Multijet (77 kW) / 0,9 CNG (59/63 kW)	
	5x98x58				
	ET 39				
	€ 66,60	Kegel sw 17 M12 x 1,25 x 22		Einige Ausführungen nur 16 Zoll!	
RDKS	ASC; ASS; CUC; CUS; Huf 2.4; Huf 3.4; Huf 3.5; SE1C1; SE1C2; SE2C2; SE1S; SE2S; TTC / OE: Schrader 3016				





500 L			10/12-	199	
Stahl	FL 516007	8053	163328	Mini-Van	
	6 J x16 H2	195/60R16C		0,9 TwinAir (77 kW) / 1,3 16V Multijet (62/77 kW)	
	5x98x58	205/55R16		0,9 TwinAir (77 kW) / 1,3 Multijet (62/77 kW) / 1,6 Multijet (77 kW) / 0,9 CNG (59/63 kW)	
	ET 36,5				
	€ 79,80	Kegel sw 17 M12 x 1,25 x 22		195/60R16C nicht für alle Versionen zulässig! Nicht 70/88 kW!	
RDKS	ASC; ASS; CUC; CUS; Huf 2.4; Huf 3.4; SE1C1; SE1C2; SE1S; TTC; TTS / OE: Schrader 3016				





500 L			10/12-	199	
Stahl	FL 616007	8049	163395	Mini-Van	
	6 J x16 H2	205/55R16		1,4i 16V (70 kW) / 1,4T (88kW) / 1,6 Multijet (88 kW)	
	5x98x58				
	ET 36,5				
	€ 79,80	Kegel sw 17 M12 x 1,25 x 22		Nur 70/88 kW!	
RDKS	ASC; ASS; CUC; Huf 2.4; Huf 3.4; Huf 3.5; SE1C1; SE1C2; SE2C1; SE2C2; SE1S; SE2S; TTC / OE: Schrader 3016				



		199	06/13-	500 L Living/Trekking		
	SUV	154603	8737	FL 515024		
	0,9 TwinAir (77 kW)/ 1,3 Multijet (62 kW)/ 1,6 Multijet (77 kW)/ 0,9 CNG (59/63 kW)	195/65R15		6 J x15 H2 5x98x58 ET 39		
Einige Ausführungen nur 16 Zoll!		Kegel sw 17 M12 x 1,25 x 22		€ 66,60		
		ASC; ASS; CUC; CUS; Huf 2.4; Huf 3.4; Huf 3.5; SE1C1; SE1C2; SE2C2; SE1S; SE2S; TTC / OE: Schrader 3016				RDKS

		199	06/13-	500 L Living/Trekking		
	SUV	163328	8053	FL 516007		
	0,9 TwinAir (77 kW)/ 1,3 Multijet (62/77 kW)/ 1,6 Multijet (77 kW)/ 0,9 CNG (63 kW)	205/55R16		6 J x16 H2 5x98x58 ET 36,5		
Nicht 70/88 kW!		Kegel sw 17 M12 x 1,25 x 22		€ 79,80		
		ASC; ASS; CUC; CUS; Huf 2.4; Huf 3.4; SE1C1; SE1C2; SE1S; TTC; TTS / OE: Schrader 3016				RDKS

		199	06/13-	500 L Living/Trekking		
	SUV	163395	8049	FL 616007		
	1,4i 16V (70 kW)/ 1,4T (88kW)/ 1,6 Multijet (88 kW)	205/55R16		6 J x16 H2 5x98x58 ET 36,5		
Ausschließlich für 70 kW und 88 kW!		Kegel sw 17 M12 x 1,25 x 22		€ 79,80		
		ASC; ASS; CUC; Huf 2.4; Huf 3.4; Huf 3.5; SE1C1; SE1C2; SE2C1; SE2C2; SE1S; SE2S; TTC / OE: Schrader 3016				RDKS

		334	01/15-	500X		
	SUV	163384	8887	FL 516008		
	1,4i (103/125 kW)/ 1,6i (82 kW)/ 1,6 D (88 kW)/ 2,0 D(103 kW)/ 4x4	215/60R16		6½ J x16 H2 5x110x65 ET 40		
		Kegel sw 24 M14 x 1,5 x 28		€ 79,80		
		Huf 3.5; SE1S; SE2S				RDKS

		334	500X		
Radabbildung in Vorbereitung					RDKS
				in Vorbereitung	

Aegea		11/15-			
Stahl	INFO			Stufenheck	Radabbildung in Vorbereitung
				INFO	
RDKS					

Bravo		04/07-07/14		198	
Stahl	FL 515012	7835	154592	Schrägheck	
	6 J x15 H2	195/65R15		1,4 16V (66 kW)/ 1,4 T-Jet 16V (88/110 kW)/	
	4x98x58			1,6 Multijet 16V (77/88 kW)/ 1,9 Multijet 16V (110 kW)	
	ET 31,5				
	€ 66,60	Kegel sw 17 M12 x 1,25 x 22			
RDKS		ASC; ASS; CUC; CUS; Huf2.4; Huf3.4; Huf3.5; SE1C1; SE1C2; SE2C2; SE1S; SE2S; TTC / OE: TRW 51839114			

Bravo		04/07-07/14		198	
Stahl	FL 516004	9087	163385	Schrägheck	
	7 J x16 H2	205/55R16		1,4 16V (66 kW)/ 1,4 T-Jet 16V (88/110 kW)/	
	4x98x58			1,6 Multijet 16V (77/88 kW)/ 1,9 Multijet 16V (110 kW)	
	ET 31				
	€ 87,70	Kegel sw 17 M12 x 1,25 x 22			
RDKS		ASC; ASS; CUC; Huf2.4; SE1C1; SE2C2; SE1S / OE: TRW 51839114			

Doblo (Facelift)		10/05-01/10		223	
Stahl	FL 615004	6815	154591	Mini-Van	
	5½ J x15 H2	185/65R15		1,4 8V (57 kW)/ 1,3 JTD 16V (62 kW)/	
	4x98x58			1,9 JTD 8V (77/88 kW)	
	ET 32				
	€ 71,90	Kegel sw 17 M12 x 1,25 x 22			
RDKS					

Doblo (Facelift)		10/05-01/10		223L	
Stahl	FL 614003	6225	143693	Kasten	
	5½ J x14 H2	175/70R14		1,4 8V (57 kW)/ 1,3 JTD 16V (55 kW)/	
	4x98x58	175/75R14		1,9 JTD 8V (74 kW)	
	ET 32	175/70R14		1,6 NaturalPower	
		Kegel sw 17 M12 x 1,25 x 22			
RDKS					

		223L	10/05-01/10	Doblo (Facelift)	
	Kasten	154591	6815	FL 615004	
	1,4 8V (57 kW)/ 1,3 JTD 16V (55 kW)/ 1,9 JTD 8V (74 kW)	185/65R15		5½ J x15 H2 4x98x58 ET 32	
		Kegel sw 17 M12 x 1,25 x 22		€ 71,90	
RDKS					
		263	02/10-	Doblo	
	Mini-Van	154595	7395	FL 615006	
	1,3-16V Multijet (66 kW)/ 1,6-16V Multijet (77 kW)	185/65R15		6 J x15 H2 5x98x58 ET 39	
		Kegel sw 17 M12 x 1,25 x 22		€ 72,40	
OE: Schrader 3016 RDKS					
		263	02/10-	Doblo	
	Kasten	154595	7395	FL 615006	
	1,3-16V Multijet (66 kW)/ 1,6-16V Multijet (74 kW)	185/65R15 195/65R15		6 J x15 H2 5x98x58 ET 39	
	Nicht zulässig für: Version MAXI, 1,4i-16V, 2,0-16V Multijet und allen Versionen mit größere Bremsscheiben vorne! Reifenabmessungen in den Fahrzeugunterlagen beachten!	Kegel sw 17 M12 x 1,25 x 22		€ 72,40	
OE: Schrader 3016 RDKS					
		263	02/10-10/14	Doblo	
	Mini-Van	163383	8048	*FL 516002	
	1,4i-16V (70/88 kW)/ 1,3-16V Multijet (66 kW)/ 1,6-16V Multijet (77 kW)/ 2,0-16V Multijet (99 kW)	195/60R16C		6 J x16 H2 5x98x58 ET 36,5	
		Kegel sw 17 M12 x 1,25 x 22		€ 79,80	
SE2S RDKS					
		263	11/14-	Doblo	
	Mini-Van	163395	8049	FL 616007	
	1,4i-16V (70/88 kW)/ 1,3-16V Multijet (66 kW)/ 1,6-16V Multijet (77 kW)/ 2,0-16V Multijet (99 kW)/ 1,4i NaturalPower (88 kW)	195/60R16C		6 J x16 H2 5x98x58 ET 36,5	
	Für TPMS modifiziertes Rad.	Kegel sw 17 M12 x 1,25 x 22		€ 79,80	
ASC ; AS5 ; CUC ; Huf 2.4 ; Huf 3.4 ; Huf 3.5 ; SE1C1 ; SE1C2 ; SE2C1 ; SE2C2 ; SE15 ; SE25 ; TTC / OE: Schrader 3016 RDKS					





Doblo / Doblo MAXI			02/10-	263	
Stahl	*FL 516002	8048	163383	Kasten	
	6 J x16 H2	195/60R16C		1,4i-16V (70/88 kW)/ 1,3-16V Multijet (66 kW)/	
	5x98x58			1,6-16V Multijet (74 kW)/ 2,0-16V Multijet (99 kW)/	
	ET 36,5			1,4i NaturalPower (88 kW)	
	€ 79,80	Kegel sw 17 M12 x 1,25 x 22			
RDKS	SE25				

Doblo / Doblo MAXI			02/10-	263	
Stahl	FL 616007	8049	163395	Kasten	
	6 J x16 H2	195/60R16C		1,4i-16V (70/88 kW)/ 1,3-16V Multijet (66 kW)/	
	5x98x58			1,6-16V Multijet (74 kW)/ 2,0-16V Multijet (99 kW)/	
	ET 36,5			1,4i NaturalPower (88 kW)	
	€ 79,80	Kegel sw 17 M12 x 1,25 x 22			
RDKS	ASC ; ASS ; CUC ; Huf 2.4 ; Huf 3.4 ; Huf 3.5 ; SE1C1 ; SE1C2 ; SE2C1 ; SE2C2 ; SE1S ; SE2S ; TTC / OE: Schrader 3016				

Ducato			03/94-02/02	230, 230D, 230L, 230M, 230P	
Stahl	*FL 615001	8875	154582	Bus, Kasten, Pritsche	
	6 J x15 H2	195/70R15		2,0i/1,9D/1,9TD/2,5D/2,5TDI, 2,8 DTI	
	5x118x71,1				
	ET 68				
	€ 94,00	Kegel sw 22 M14 x 1,5 x 30		FZG-Schein muss unbedingt beachtet werden: Je nach Ausführung und Motorisierung sind unterschiedliche Reifenabmessungen vorgeschrieben. Bei einigen Ausführungen ist ausschließlich 16 Zoll zulässig.	
RDKS					

Ducato			03/94-02/02	230, 230 D, 230L, 230M	
Stahl	*FL 616002	9600	163380	Bus, Kasten, Pritsche	
	6 J x16 H2	205/75R16		2,0i/1,9D/1,9TD/2,5D/2,5TDI	
	5x130x78,1				
	ET 68				
	€ 107,80	Kegel sw 24 M16 x 1,5 x 31		FZG-Schein muss unbedingt beachtet werden: Je nach Ausführung und Motorisierung sind unterschiedliche Reifenabmessungen vorgeschrieben. Bei einigen Ausführungen ist ausschließlich 15 Zoll zulässig.	
RDKS					

Ducato			03/02-05/06	244, 244 D, 244 L, 244 M	
Stahl	*FL 615001	8875	154582	Bus, Kasten, Pritsche	
	6 J x15 H2	195/70R15		2,0i/ 2,0 JTD/ 2,3 JTD/ 2,8 JTD/ 2,0 Bipower	
	5x118x71,1	205/70R15			
	ET 68	225/70R15			
	€ 94,00	Kegel sw 24 M14 x 1,5 x 28		FZG-Schein muss unbedingt beachtet werden: Je nach Ausführung und Motorisierung sind unterschiedliche Reifenabmessungen vorgeschrieben. Bei einigen Ausführungen ist ausschließlich 16 Zoll zulässig.	
RDKS					

		244, 244 B, 244 D, 244 L, 244 M	03/02-05/06	Ducato (Maxi)	
	Bus, Kasten, Pritsche	163380	9600	*FL 616002	Stahl
	2,0i/ 2,0 JTD/ 2,3 JTD/ 2,8 JTD/ 2,0 Bipower	205/75R16 215/75R16		6 J x16 H2 5x130x78,1 ET 68	
	FZG-Schein muss unbedingt beachtet werden: Je nach Ausführung und Motorisierung sind unterschiedliche Reifenabmessungen vorgeschrieben. Bei einigen Ausführungen ist ausschließlich 15 Zoll zulässig.	Kegel sw 24 M16 x 1,5 x 31		€ 107,80	
					RDKS
		250, 250 D, 250 L, 250 M	06/06-04/14	Ducato	
	Bus, Kasten, Pritsche	154590	8877	*FL 615002	Stahl
	100 Multijet (74 kW)/ 115 Multijet (85 kW)/ 120 Multijet (88 kW)/ 130 Multijet (96 kW)/ 150 Multijet (109 kW)/ 180 Multijet (130 kW) 160 Multijet Power (116 kW)/ 3,0 Natural Power (100 kW)	205/70R15 215/70R15 225/70R15		6 J x15 H2 5x118x71,1 ET 68	
	FZG-Schein muss unbedingt beachtet werden: Je nach Ausführung und Motorisierung sind unterschiedliche Reifenabmessungen vorgeschrieben.	Kegel sw 21 M14 x 1,5 x 27		€ 94,00	
					RDKS
		250, 250 D, 250 L, 250 M	06/06-04/14	Ducato	
	Bus, Kasten, Pritsche	154547	4011	FL 615007	Stahl
	100 Multijet (74 kW)/ 115 Multijet (85 kW)/ 120 Multijet (88 kW)/ 130 Multijet (96 kW)/ 150 Multijet (109 kW)/ 180 Multijet (130 kW) 160 Multijet Power (116 kW)/ 3,0 Natural Power (100 kW)	205/70R15 215/70R15 225/70R15		6 J x15 H2 5x118x71,1 ET 68	
	FZG-Schein muss unbedingt beachtet werden: Je nach Ausführung und Motorisierung sind unterschiedliche Reifenabmessungen vorgeschrieben. Ersetzt FL 615002. TPMS modifiziertes Rad.			€ 94,00	
					RDKS
		250, 250 B, 250 D, 250 L, 250 M	06/06-04/14	Ducato (Maxi)	
	Bus, Kasten, Pritsche	163381	9601	FL 616004	Stahl
	120 Multijet (88 kW)/ 130 Multijet (96 kW)/ 150 Multijet (109 kW)/ 160 Multijet Power (116 kW)/ 180 Multijet (130 kW)/ 3,0 Natural Power (100 kW)	215/75R16 225/75R16		6 J x16 H2 5x130x78,1 ET 68	
	FZG-Schein muss unbedingt beachtet werden: Je nach Ausführung und Motorisierung sind unterschiedliche Reifenabmessungen vorgeschrieben.	Kegel sw 21 M16 x 1,5 x 29		€ 107,80	
					RDKS
		250	05/14-	Ducato	
	Bus, Kasten, Pritsche	154547	4011	FL 615007	Stahl
	115 Multijet (85 kW)/ 130 Multijet (96 kW)/ 150 Multijet (109 kW)/ 180 Multijet Power (130 kW)	215/70R15 225/70R15		6 J x15 H2 5x118x71,1 ET 68	
	MJ 2014. FZG-Schein muss unbedingt beachtet werden: Je nach Ausführung und Motorisierung sind unterschiedliche Reifenabmessungen vorgeschrieben.			€ 94,00	
				ASC ; ASS ; CUC ; Huf 3.5 ; SE1C1 ; SE1C2 ; SE2C1 ; SE2C2 ; SE15 ; SE25 ; TTC ; TTS / OE-Schrader 3009	RDKS

Ducato		05/14-	250	
Stahl	FL 616008		163396	Bus, Kasten, Pritsche
	6 J x16 H2	215/75R16		115 Multijet (85 kW)/ 130 Multijet (96 kW)/ 150 Multijet (109 kW)/ 180 Multijet Power (130 kW)
	5x118x71,1	225/75R16		
	ET 68			
	€ 107,80			MJ 2014. Je nach Ausführung und Motorisierung sind unterschiedliche Reifenabmessungen vorgeschrieben. Für Fahrzeuge mit Anschluss: 5x118x71,1.
RDKS	OE: Schrader 3009			



Ducato (Maxi)		05/14-	250	
Stahl	FL 616009	7011	163397	Bus, Kasten, Pritsche
	6 J x16 H2	215/75R16		115 Multijet (85 kW)/ 130 Multijet (96 kW)/ 150 Multijet (109 kW)/ 180 Multijet Power (130 kW)
	5x130x78,1	225/75R16		
	ET 68			
	€ 107,80			MJ 2014. Je nach Ausführung und Motorisierung sind unterschiedliche Reifenabmessungen vorgeschrieben. Für Fahrzeuge mit Anschluss: 5x130x78,1.
RDKS	OE: Schrader 3009			



Fiorino		02/08-	225L	
Stahl	FL 614004	6805	143695	Kasten
	5½ J x14 H2	175/70R14		1,4 8V (54 kW)/ 1,3 Multijet 16V (55kW)
	4x98x58			
	ET 44			
	€ 58,10	Kegel sw 17 M12 x 1,25 x 22		
RDKS	ASC; ASS; Huf 2.4; Huf 3.5; SE2S			



Fiorino		02/08-	225L	
Stahl	FL 515013	7680	154594	Kasten
	6 J x15 H2	185/65R15		1,4 8V (54 kW)/ 1,3 Multijet 16V (55kW)
	4x98x58			
	ET 44			
	€ 66,60	Kegel sw 17 M12 x 1,25 x 22		
RDKS	ASC; ASS; CUC; CUS; Huf 2.4; Huf 3.4; SE1C1; SE1C2; SE1S; TTC; TTS			



Fiorino Adventure		04/08-	225L	
Stahl	FL 515013	7680	154594	SUV
	6 J x15 H2	185/65R15		1,4 8V (54 kW)/ 1,3 Multijet 16V (55kW)/ 1,4 8V NaturalPower (57/51 kW)
	4x98x58			
	ET 44			
	€ 66,60	Kegel sw 17 M12 x 1,25 x 22		
RDKS	ASC; ASS; CUC; CUS; Huf 2.4; Huf 3.4; SE1C1; SE1C2; SE1S; TTC; TTS			





		225	09/08-	Fiorino Qubo	
	Kombi	154594	7680	FL 515013	Stahl
	1,4 8V (54 kW)/ 1,3 Multijet 16V (55kW)/ 1,4 8V NaturalPower (57/51 kW)	185/65R15		6 J x15 H2 4x98x58 ET 44	
			Kegel sw 17 M12 x 1,25 x 22	€ 66,60	RDKS
			ASC; ASS; CUC; CUS; Huf 2.4; Huf 3.4; SE1C1; SE1C2; SE1S; TTC; TTS / OE: Schrader 3016		
		JC	09/11-	Freemont	
	Van	163326	9517	FL 516006	Stahl
	3,6i (206 kW)/ 2,0 D (103/125 kW)/ 4WD	225/65R16		6½ J x16 H2 5x127x71,5 ET 40	
	Nicht in Verbindung mit 17" Bremsen-Paket!		Kegel sw 19 M12 x 1,5	€ 89,20	RDKS
			ASC; ASS; CUC; CUS; Huf 2.4; Huf 3.4; Huf 3.5; SE1C1; SE1C2; SE1S; TTC / OE: Schrader 3016		
		350	01/04-	Idea	
	Mini-Van	154589	8185	FL 515009	Stahl
	1,2 16V (59 kW)/ 1,4 8V (57 kW)/ 1,4 16V (70 kW)/ 1,3 JTD (51/66 kW)/ 1,9 JTD (74 kW)	195/60R15		6 J x15 H2 4x98x58 ET 40	
			Kegel sw 17 M12 x 1,25 x 22	€ 74,00	RDKS
			ASC; ASS; CUC; Huf 2.4; Huf 3.4; SE1C1; SE1S; TTC; TTS / OE: Schrader 3017		
		323	07/07-10/15	Linea	
	Stufenheck	154594	7680	FL 515013	Stahl
	1,4 8V (57 kW)/ 1,4 T-Jet 16V (88 kW)/ 1,3 Multijet 16V (66/77 kW)	185/65R15 195/60R15		6 J x15 H2 4x98x58 ET 44	
			Kegel sw 17 M12 x 1,25 x 22	€ 66,60	RDKS
			ASC; ASS; CUC; CUS; Huf 2.4; Huf 3.4; SE1C1; SE1C2; SE1S; TTC; TTS / OE: Schrader 3016		
		186	04/99-02/10	Multipla	
	Mini-Van	154592	7835	FL 515012	Stahl
	1,6i (75 kW)/1,9 JTD	185/65R15		6 J x15 H2 4x98x58 ET 31,5	
			Kegel sw 17 M12 x 1,25 x 22	€ 66,60	RDKS
			ASC; ASS; CUC; CUS; Huf 2.4; Huf 3.4; Huf 3.5; SE1C1; SE1C2; SE2C2; SE1S; SE2S; TTC		

Panda			09/03-01/12	169	
Stahl	FL 513011	4450	133488	Schrägheck	
	5.00 B x13 H	155/80R13		1,1i (40 kW)/ 1,2i (44/51kW)/ 1,3 JTD (51 kW)	
	4x98x58 ET 35				
	€ 51,30	Kegel sw 17 M12 x 1,25 x 22			
RDKS					

Panda Classic			02/12-	169	
Stahl	FL 513011	4450	133488	Schrägheck	
	5.00 B x13 H	155/80R13		1,2i (51 kW)	
	4x98x58 ET 35				
	€ 51,30	Kegel sw 17 M12 x 1,25 x 22		Baureihe wird parallel zum neuen Panda (Typ: 312) weitergebaut.	
RDKS ASC; ASS; CUC; Huf 2.4; Huf 3.4; Huf 3.5; SE1C1; SE1C2; SE2C1; SE2C2; SE1S; SE2S; TTC					

Panda			02/12-	312	
Renner	FL 514026	6315	143694	Schrägheck	
	5½ J x14 H2	175/65R14		0,9i (63 kW)/ 1,2i (51 kW)/ 1,3 JTD (55 kW)	
	4x98x58 ET 35				
	€ 56,50	Kegel sw 17 M12 x 1,25 x 22			
RDKS CUC; Huf 3.5; SE1C1; SE1C2; SE1S; SE2S					

Panda 4x4			09/03-02/12	169	
Stahl	FL 514018	6165	143681	SUV	
	5½ J x14 H2	165/70R14 M+S		1,2i (44/51 kW)	
	4x98x58	175/65R14			
	ET 35	165/70R14 M+S		1,3 JTD (51 kW)	
	€ 56,50	Kegel sw 17 M12 x 1,25 x 22		FZG-Schein beachten: Einige FZG-Ausführungen nur M+S zulässig! Einigen Ausführungen auch 185/65R14 M+S.	
RDKS					

Panda 4x4 Classic			02/12-	169	
Stahl	FL 514018	6165	143681	SUV	
	5½ J x14 H2	165/70R14 M+S		1,2i (51 kW)	
	4x98x58	185/65R14			
	ET 35				
	€ 56,50	Kegel sw 17 M12 x 1,25 x 22		185/65R14 nicht bei allen Ausführungen zulässig! Baureihe wird parallel zum neuen Panda 4x4 (Typ: 312) weitergebaut.	
RDKS CUC; Huf 3.5; SE1C1; SE1C2; SE1S; SE2S					

		312	03/13-	Panda 4x4	
	SUV	154536	7355	FL 515023	
	1,2i (51 kW)/ 1,3 JTD (55 kW)	175/65R15		6 J x15 H2 4x98x58 ET 35	
		Kegel sw 17 M12 x 1,25 x 22		€ 66,60	
RDKS					

		188	09/99-01/07	Punto / Punto Start	
	Schrägheck	143681	6165	FL 514018	
	1,2i-8V (44kW)/ 1,6i-16V (59kW)/ 1,4i-16V (70 kW)/ 1,3 JTD-16V (51 kW)/ 1,9 JTD (59/ 63 kW)	165/70R14		5½ J x14 H2 4x98x58 ET 35	
Nicht für 1,8i-16V (96 kW) zulässig! FZG-Schein beachten. Einige FZG-Ausführungen nur 15 Zoll. Fahrzeug wurde parallel zum neuen „Grande Punto“ weiterproduziert.		Kegel sw 17 M12 x 1,25 x 22		€ 56,50	
RDKS					

		199	10/05-09/09	Punto (Grande)	
	Schrägheck	155101	7915	FL 515010	
	1,2i-8V (48 kW)/ 1,4i-8V (57 kW)/ 1,3 Multijet (55 kW)	175/65R15		6 J x15 H2	
	1,2i-8V (48 kW)/ 1,4i-8V (57 kW)/ 1,4i-16V (70 kW)/ 1,3 Multijet (55/66 kW)/ 1,6 Multijet (88 kW)/ 1,9 Multijet (88/96 kW)	185/65R15		4x100x56,5 ET 43	
	Grande Punto 1,2 8V (48 kW) wird parallel weitergebaut 10/09-.	Kegel sw 17 M12 x 1,5 x 22		€ 66,00	
RDKS					

		199	10/09-	Punto (Evo)	
	Schrägheck	155101	7915	FL 515010	
	1,2i-8V (48/51 kW)/ 1,4i-8V (57 kW)/ 1,3 Multijet (55 kW)	175/65R15		6 J x15 H2	
	1,2i-8V (48 kW)/ 1,4i-8V (57 kW)/ 1,4i-16V (77/99 kW)/ 1,3 Multijet (55/70/88 kW)/ 1,4 8V NaturalPower (57/51 kW)	185/65R15		4x100x56,5 ET 43	
	Grande Punto 1,2 8V (48 kW) wird parallel weitergebaut 10/09-.	Kegel sw 17 M12 x 1,5 x 22		€ 66,00	
ASS; Huf 3.5; SE1S; SE2S					
RDKS					

		199	Punto (Grande / Evo)			
		lichtsilber-lackiert / mattschwarz-lackiert	Seismo		SO 605 38 4 00	
		lichtsilber-lackiert / mattschwarz-lackiert	Interio		IN 605 38 4 00	
		ABE	175/65R15	6 J x15 H2 4 x 100 ET 38		MAGMA
		TÜV	185/65R15			
SO		MK 207		Seismo: ASC; ASS; Huf 2.4; Huf 3.4; SE1C1; SE1C2; SE1S; TTC Interio: ASC; ASS; CUS; Huf 2.4; Huf 3.4; SE1C1; SE1C2; SE1S; TTC; TTS		RDKS

Scudo		10/06-	270 L	
Stahl	PS 615002	7670	154559	Kasten
	6½ J x15 H2	215/65R15		1,6 Multijet 90 (66 kW)/ 2,0 Multijet 120 (88 kW)/ 2,0 Multijet 140 (100 kW)
	5x108x65 ET 38			
	€ 84,50	Kegel sw 17 M12 x 1,25 x 26		Bei einigen Ausführungen ist ausschließlich 16 Zoll zulässig.
RDKS	ASC; ASS; CUC; CUS; Huf 2.4; Huf 3.4; Huf 3.5; SE1C1; SE1C2; SE2C1; SE2C2 ; SE1S; SE2S; TTC / OE: Schrader 3003			



Scudo		10/06-	270 L	
Stahl	PS 616001	7780	163363	Kasten
	7 J x16 H2	215/60R16		2,0 16V (103 kW)/ 1,6 Multijet 90 (66 kW)/ 2,0 Multijet 120/130/140/165 (88/94/100/120 kW)
	5x108x65 ET 42			
	€ 90,90	Kegel sw 17 M12 x 1,25 x 26		
RDKS	ASC; ASS; CUC; CUS; Huf 2.4; Huf 3.4; Huf 3.5; SE1C1; SE1C2; SE2C1; SE2C2 ; SE1S; SE2S; TTC; TTS / OE: Schrader 3003			



Scudo		10/06-	270	
Stahl	PS 616001	7780	163363	Kombi
	7 J x16 H2	215/60R16		2,0 16V (103 kW)/ 1,6 Multijet 90 (66 kW)/ 2,0 Multijet 120/130/140/165 (88/94/100/120 kW)
	5x108x65 ET 42			
	€ 90,90	Kegel sw 17 M12 x 1,25 x 26		
RDKS	ASC; ASS; CUC; CUS; Huf 2.4; Huf 3.4; Huf 3.5; SE1C1; SE1C2; SE2C1; SE2C2 ; SE1S; SE2S; TTC; TTS / OE: Schrader 3001			





Sedici		04/06-08/14	FY	
Stahl	SU 515002	7150	154651	SUV
	6 J x15 H2	195/65R15		1,6i 16V (79 kW)/ 1,9 Multijet 8V (88 kW)
	5x114,3x60 ET 50			
	€ 71,30	Kegel sw 17 M12 x 1,5 x 22		
RDKS				



Sedici		04/06-08/14	FY	
Stahl	SU 516004	8315	163435	SUV
	6 J x16 CH	205/60R16		1,6i 16V (79 kW)/ 1,9 Multijet 8V (88 kW)
	5x114,3x60 ET 50			
	€ 78,20	Kegel sw 17 M12 x 1,5 x 22		
RDKS				



FY		Sedici			
		lichtsilber-lackiert		Celsio	CS 656 40 5 14
		lichtsilber-lackiert / mattschwarz-lackiert		Tezzo	TZ 656 40 5 14
		ABE	205/55R16 ☼	6½ J x16 H2	
		ABE	205/60R16 ☼	5 x 114,3	
MK 203		ABE	215/55R16	ET 40	
		Celsio: ASC; ASS; CUC; Huf 2.4; Huf 3.4; Huf 3.5; SE1C1; SE1C2; SE1S; TTC; TTS Tezzo: ASC; ASS; CUC; Huf 2.4; Huf 3.4; Huf 3.5; SE1C1; SE1C2; SE1S; TTC			RDKS

MAGMA

192		09/01-03/07	Stilo / Stilo MW	
	Schrägheck, Multi Wagon	154588	8085	FL 515008
	1,2 16V/1,4 16V/1,6 16V/1,8 16V/ 1,9 JTD/1,9 Multijet	195/65R15		6½ J x15 H2 4x98x58 ET 43
	Stilo MW -12/07	Kegel sw 17 M12 x 1,25 x 22		€ 67,60
				RDKS



Stahl

JK8		07/12-10/14	B-Max	
	Mini-Van	154529	7430	*FO 515016
	1,0i (74/88/92 kW)/ 1,4i (66 kW)/ 1,6i (77 kW)/ 1,5 TDCi (55 kW)/ 1,6 TDCi (70 kW)	185/60R15 195/60R15		6 J x15 H2 4x108x63,3 ET 37,5
		Kegel sw 19 M12 x 1,5/H15		€ 63,40
	SE2S			

Stahl

JK8		11/14-	B-Max	
	Mini-Van	154634	5000	FO 515017
	1,0i (74/88/92 kW)/ 1,4i (66 kW)/ 1,6i (77 kW)/ 1,5 TDCi (55 kW)/ 1,6 TDCi (70 kW)	185/60R15 195/60R15		6 J x15 H2 4x108x63 ET 37,5
	Für TPMS modifiziertes Rad.	Kegel sw 19 M12 x 1,5/H15		€ 63,40
	ASC; ASS; CUC; CUS; Huf 2.4; Huf 3.4; Huf 3.5; SE1C2; SE2C2; SE1S; SE2S; TTC; TTS / OE: Schrader 3021			

Stahl

B-Max			JK8		
MAGNUM	Interio		IN 605 38 4 08	lichtsilber-lackiert / mattschwarz-lackiert	
	6 J x15 H2	185/60R15	⊗	ABE	
	4 x 108	195/60R15	⊗	ABE	
	ET 38				
RDKS	ASC; ASS; CUS; Huf 2.4; Huf 3.4; SE1C1; SE1C2; SE1S; TTC; TTS / OE: Schrader 3021			MK 041	



C-Max (Focus C-Max)			06/03-04/07	DM2		
Renner	FO 515014	8795	154509	Mini-Van		
	6 J x15 H2	195/65R15		1,6i-16V (74 kW)/ 1,6 Ti VCT (85 kW)/ 1,8i (88 kW)/ 1,8i-16V (92 kW)/ 1,6 TDCi (66/ 80 kW)		
	5x108x63,3					
	ET 52,5					
RDKS	€ 63,40	Kegel sw 19 M12 x 1,5/H15		FZG-Schein beachten. Bei einigen Ausführungen ist FO 515014 nur für M+S Bereifung zulässig.		

C-Max (Focus C-Max)			06/03-04/07	DM2		
Stahl	FO 516005	9975	163903	Mini-Van		
	6½ J x16 H2	205/55R16		1,6i-16V (74 kW)/ 1,6 Ti VCT (85 kW)/ 1,8i (88 kW)/ 1,8i-16V (92 kW)/ 2,0i-16V (107 kW)/ 1,6 TDCi (66/ 80 kW)/ 1,8 TDCi (85 kW)/ 2,0 TDCi (100 kW)		
	5x108x63,3					
	ET 52,5					
RDKS	€ 75,50	Kegel sw 19 M12 x 1,5/H15		FZG-Schein beachten. Bei einigen Ausführungen ist FO 516005 nur für M+S Bereifung zulässig.		

C-Max			05/07-09/10	DM2		
Renner	FO 515014	8795	154509	Mini-Van		
	6 J x15 H2	195/65R15		1,6i/ 1,6 Ti/ 1,8 FlexiFuel		
	5x108x63,3					
	ET 52,5					
RDKS	€ 63,40	Kegel sw 19 M12 x 1,5/H15				



C-Max			05/07-09/10	DM2		
Stahl	FO 516005	9975	163903	Mini-Van		
	6½ J x16 H2	205/55R16		1,6i/ 1,6 Ti/ 1,8 FlexiFuel/ 2,0i/ 1,6 TDCi/ 1,8 TDCi/ 2,0 TDCi/		
	5x108x63,3					
	ET 52,5					
RDKS	€ 75,50	Kegel sw 19 M12 x 1,5/H15				

		DM2	05/07-09/10	C-Max	
	Mini-Van	163906	8325	FO 516008	Renner
	1,6i/ 1,6 Ti/ 1,8 FlexiFuel/ 2,0i/ 1,6 TDCi/ 1,8 TDCi/ 2,0 TDCi/	205/55R16		6½ J x16 H2 5x108x63,3 ET 50	
		Kegel sw 19 M12 x 1,5/H15		€ 75,00	RDKS

		DM2	C-Max		
		lichtsilber-lackiert	Celsio	CS 656 43 5 08	
		lichtsilber-lackiert / mattschwarz-lackiert	Seismo	SO 656 43 5 08	
		ABE	205/55R16	6½ J x16 H2	
		ABE	205/55R16 M+S	5 x 108 ET 43	
MK 042		Celsio: ASC; ASS; CUC; Huf 2.4; Huf 3.4; Huf 3.5; SE1C1; SE1C2; SE1S; TTC; TTS Seismo: ASC; ASS; CUC; Huf 2.4; Huf 3.4; Huf 3.5; SE1C1; SE1C2; SE1S; TTC; TTS			
		RDKS			

		DXA	10/10-	C-Max	
	Mini-Van	163906	8325	FO 516008	Renner
	1,0i (74/92 kW)/ 1,6i (63/77/92/110/134 kW)/	205/55R16		6½ J x16 H2	
	1,6 FlexiFuel (86/88 kW)/ 1,6 TDCi (70/85 kW)/ 2,0 TDCi (85 kW)	215/55R16		5x108x63,3	
	2,0 TDCi (100/103/120 kW)	215/55R16		ET 50	
Bis max. 1300 kg Achslast!		Kegel sw 19 M12 x 1,5/H15		€ 75,00	RDKS
		ASC; ASS; CUC; Huf 2.4; Huf 3.4; Huf 3.5; SE1C1; SE1C2; SE2C1; SE2C2; SE1S; SE2S / OE: Schrader 3021			



		DXA	10/10-	C-Max (Grand)	
	Mini-Van	163906	8325	FO 516008	Renner
	1,6i (77/92 kW)	205/55R16		6½ J x16 H2	
	1,0i (74/92 kW)/ 1,6i (110/134 kW)/	215/55R16		5x108x63,3	
	1,6 TDCi (70/85 kW) / 2,0 TDCi (85/100/103/120 kW)			ET 50	
Bis max. 1300 kg Achslast!		Kegel sw 19 M12 x 1,5/H15		€ 75,00	RDKS
		ASC; ASS; CUC; Huf 2.4; Huf 3.4; Huf 3.5; SE1C1; SE1C2; SE2C1; SE2C2; SE1S; SE2S / OE: Schrader 3021			

		DXA	C-Max / Grand C-Max		
		lichtsilber-lackiert / mattschwarz-lackiert	Tezzo	TZ 656 45 5 08	
		ABE	205/55R16 ❄	6½ J x16 H2	
		ABE	215/55R16 ❄	5 x 108 ET 45	
		MK 042		ASC; ASS; CUC; Huf 2.4; Huf 3.4; Huf 3.5; SE1C1; SE1C2; SE1S; TTC / OE: Schrader 3021	
		RDKS			



C-Max / Grand C-Max				DXA
MAGNUM	Celsio		CS 707 47 5 08	lichtsilber-lackiert
	7 J x17 EH2+	205/50R17	⊗	ABE
	5 x 108	215/45R17	⊗	ABE
	ET 47	225/45R17	⊗	ABE
RDKS	ASC ; ASS ; CUC ; Huf 2.4 ; Huf 3.4 ; Huf 3.5 ; SE1C1 ; SE1C2 ; SE1S ; TTC / OE: Schrader 3021			MK 042
CS				
EcoSport				
		06/14-	JK8	
Stahl	FO 515018	8442	154635	SUV
	6 J x15 H2	195/65R15		1,0i EcoBoost (92 kW)/ 1,5Ti-VCT (82 kW)/ 1,5 TDCi (66 kW)
	4x108x63			
	ET 37,5			
€ 63,40	Kegel sw 19 M12 x 1,5			
RDKS	ASC ; ASS ; CUC ; CUS ; Huf 2.4 ; Huf 3.4 ; Huf 3.5 ; SE1C1 ; SE1C2 ; SE2C2 ; SE1S ; SE2S ; TTC ; TTS / OE: Schrader 3021			
Fiesta				
		04/02-09/08	JH1, JD3	
Stahl	FO 514010	6275	143304	Schrägheck
	5½ J x14 H2	175/65R14		1,3i/1,4i-16V/1,6i-16V/1,4 TDCi/1,6 TDCi
	4x108x63,3			
	ET 47,5			
€ 57,10	Kegel sw 19 M12 x 1,5/H15			
RDKS				
Fiesta				
		04/02-09/08	JH1, JD3	
Stahl	FO 515007	8200	153802	Schrägheck
	6 J x15 H2	195/50R15		1,3i/1,4i-16V/1,6i-16V/1,4 TDCi/1,6 TDCi
	4x108x63,3	185/55R15		ST 150 (110 kW)
	ET 52,5			
€ 63,40	Kegel sw 19 M12 x 1,5/H15		FZG-Schein beachten: Bei einigen Ausführungen nur 14 Zoll zulässig.	
RDKS				
Fiesta				
		10/08-	JA8, JA8-LPG, JR8	
Renner	FO 514011	6355	143605	Schrägheck
	5½ J x14 H2	175/65R14		1,0i (48/59/74/92)/ 1,25i (44/60 kW)/ 1,4i (71 kW)/ 1,6 Ti-VCT (88/99 kW)/ 1,6i (77 kW)/ 1,4 TDCi (51/66 kW)/ 1,5 TDCi (55/70 kW)/ 1,6 TDCi (70 kW)/ 1,4 LPG (66/68/71/92 kW)
	4x108x63,3			
	ET 37,5			
€ 57,10	Kegel sw 19 M12 x 1,5/H15		Bis max. 850 kg Achslast.	
RDKS	ASC ; ASS ; CUC ; Huf 2.4 ; Huf 3.4 ; Huf 3.5 ; SE1C1 ; SE1C2 ; SE2C1 ; SE2C2 ; SE1S ; SE2S ; TTC ; TTS / OE: Schrader 3021			





JA8, JA8-LPG, JR8		Fiesta		
	lichtsilber-lackiert		Celsio	CS 554 38 4 08
		ABE	175/65R14 *	5½ J x14 H2
				4 x 108
				ET 38
CS	MK 041	ASC; ASS; Huf 2.4; Huf 3.4; SE1C1; SE1C2; SE15; TTC; TTS / OE: Schrader 3021		RDKS

JA8, JA8-LPG, JR8		Fiesta			
		lichtsilber-lackiert / mattschwarz-lackiert		Interio	IN 604 38 4 08
			ABE	175/65R14 *	6 J x14 H2
					4 x 108
					ET 38
IN	IN	MK 041	ASC; ASS; Huf 2.4; Huf 3.4; SE1C1; SE1C2; SE15; TTC; TTS / OE: Schrader 3021		RDKS

JA8, JA8-LPG, JR8		10/08-		Fiesta		
	Schrägheck	154542	7255	FO 515015		
	1,0i (48/59/74/92)/ 1,25i (44/60 kW)/ 1,4i (71 kW)/	195/50R15		6 J x15 H2		
	1,6 Ti-VCT (88/99 kW)/ 1,6i (77 kW)/ 1,4 TDCi (51/66 kW)/	195/60R15		4x108x63,3		
	1,5 TDCi (55/70 kW)/ 1,6 TDCi (70 kW)/ 1,4 LPG (66/68/71/92 kW)	Kegel sw 19 M12 x 1,5/H15		ET 47,5		
Je nach Ausführung unterschiedliche Bereifung zulässig.		Kegel sw 19 M12 x 1,5/H15		€ 63,40		
		ASC; ASS; CUC; CUS; Huf 2.4; Huf 3.4; Huf 3.5; SE1C1; SE1C2; SE2C2; SE15; SE25; TTC; TTS / OE: Schrader 3021				RDKS

JA8, JA8-LPG, JR8		Fiesta			
		lichtsilber-lackiert / mattschwarz-lackiert		Interio	IN 605 38 4 08
			ABE	175/65R15 *	6 J x15 H2
			ABE	185/55R15 *	4 x 108
			ABE	195/50R15 *	ET 38
IN	IN	MK 041	ASC; ASS; CUS; Huf 2.4; Huf 3.4; SE1C1; SE1C2; SE15; TTC; TTS / OE: Schrader 3021		RDKS

JC3		08/07-04/10		Fiesta Van		
	Kasten	143304	6275	FO 514010		
	1,3i (51 kW)/ 1,6i (74 kW)/ 1,4 TDCi (50 kW)/	175/65R14		5½ J x14 H2		
	1,6 TDCi (66 kW)			4x108x63,3		
		Kegel sw 19 M12 x 1,5/H15		ET 47,5		
				€ 57,10		
						RDKS

Fiesta Van			08/07-04/10	JC3	
Stahl	FO 515007	8200	153802	Kasten	
	6 J x15 H2	195/50R15		1,3i (51 kW)/ 1,6i (74 kW)/ 1,4 TDCi (50 kW)/	
	4x108x63,3			1,6 TDCi (66 kW)	
	ET 52,5				
	€ 63,40	Kegel sw 19 M12 x 1,5/H15			
RDKS					

Fiesta Van			05/10-	JR8	
Renner	FO 514011	6355	143605	Kasten	
	5½ J x14 H2	175/65R14		1,25i (60 kW)/ 1,4 TDCi (51 kW)/ 1,5 TDCi (55 kW)/ 1,6 TDCi (70 kW)	
	4x108x63,3				
	ET 37,5				
	€ 57,10	Kegel sw 19 M12 x 1,5/H15			
RDKS ASC; ASS; CUC; Huf 2.4; Huf 3.4; Huf 3.5; SE1C1; SE1C2; SE2C1; SE2C2; SE1S; SE2S; TTC; TTS / OE: Schrader 3021					

Fiesta Van			05/10-	JR8	
Stahl	FO 515015	7255	154542	Kasten	
	6 J x15 H2	195/50R15		1,25i (60 kW)/ 1,4 TDCi (51 kW)/ 1,5 TDCi (55 kW)/ 1,6 TDCi (70 kW)	
	4x108x63,3	195/60R15			
	ET 47,5				
	€ 63,40	Kegel sw 19 M12 x 1,5/H15			
RDKS ASC; ASS; CUC; CUS; Huf 2.4; Huf 3.4; Huf 3.5; SE1C1; SE1C2; SE2C2; SE1S; SE2S; TTC; TTS / OE: Schrader 3021					

Focus I			10/98-11/04	DAW, DBW, DAX, DBX, DFW, DNW, DNX	
Stahl	FO 514007	6880	143302	Schräg-/ Stufenheck, Turnier	
	5½ J x14 CH	175/70R14 M+S		1,4i (55 kW)/1,6i (74 kW)/1,8i/1,8Di (55/66 kW)	
	4x108x63,3	185/65R14			
	ET 47,5				
	€ 57,10	Kegel sw 19 M12 x 1,5/H15		FO 514007 nur bis 978 kg Achslast zulässig!	
RDKS					

Focus I			10/98-11/04	DAW, DBW, DFW, DAX, DBX, DNW, DNX	
Stahl	FO 515007	8200	153802	Schräg-/ Stufenheck, Turnier	
	6 J x15 H2	195/55R15		1,4i (55 kW)/1,6i (74 kW)/1,8i/2,0i (96 kW)/1,8Di (55/66 kW)	
	4x108x63,3	195/60R15			
	ET 52,5				
	€ 63,40	Kegel sw 19 M12 x 1,5/H15		FZG-Schein beachten! Je nach Ausführung sind unterschiedliche Reifenabmessungen vorgeschrieben.	
RDKS					

		DA3, DB3	12/04-01/08	Focus II	
	Schräg-/ Stufenheck, Turnier		154509	8795	FO 515014
	1,4i 16V (59 kW)/ 1,6i 16V (74 kW)/ 1,8 Flexifuel/ 1,6 Ti VCT 16V (85 kW)/ 1,6 TDCi (80 kW)		195/65R15		6 J x15 H2 5x108x63,3 ET 52,5
			Kegel sw 19 M12 x 1,5/H15		€ 63,40
RDKS					

Renner

		DA3, DB3	12/04-01/08	Focus II	
	Schräg-/ Stufenheck, Turnier, Cabrio		163903	9975	FO 516005
	1,4i 16V/ 1,6i 16V/ 1,6 Ti VCT 16V/ 2,0i 16V/ 1,8 Flexifuel/ 1,6 TDCi/1,8TDCi/2,0TDCi		205/55R16		6½ J x16 H2 5x108x63,3 ET 52,5
			Kegel sw 19 M12 x 1,5/H15		€ 75,50
RDKS					



Stahl

		DA3, DB3	02/08-02/11	Focus II	
	Schräg-/ Stufenheck, Turnier		154509	8795	FO 515014
	1,4i 16V (59 kW)/ 1,6i 16V (74 kW)/ 1,8 Flexifuel/ 1,6 Ti VCT 16V (85 kW)/ 1,6 TDCi (80 kW)		195/65R15		6 J x15 H2 5x108x63,3 ET 52,5
			Kegel sw 19 M12 x 1,5/H15		€ 63,40
RDKS					

Renner

		DA3, DB3	02/08-02/11	Focus II	
	Schräg-/ Stufenheck, Turnier, Cabrio		163906	8325	FO 516008
	1,4i 16V/ 1,6i 16V/ 1,6 Ti VCT 16V/ 2,0i 16V/ 1,8 Flexifuel/ 1,6 TDCi/1,8TDCi/2,0TDCi		205/55R16		6½ J x16 H2 5x108x63,3 ET 50
			Kegel sw 19 M12 x 1,5/H15		€ 75,00
RDKS					

Renner



		DA3, DB3	Focus II		
			lichtsilber-lackiert	Celsio	CS 656 43 5 08
			lichtsilber-lackiert / mattschwarz-lackiert	Seismo	SO 656 43 5 08
		auch Focus Coupé Cabrio	ABE	205/55R16	6½ J x16 H2
			ABE	215/50R16	5 x 108
					ET 43
MK 042		Celsio: ASC; ASS; CUC; Huf2.4; Huf3.4; Huf3.5; SE1C1; SE1C2; SE1S; TTC; TTS Seismo: ASC; ASS; CUC; Huf2.4; Huf3.4; Huf3.5; SE1C1; SE1C2; SE1S; TTC; TTS			RDKS



MAGMA

CS

SO

Focus III			03/11-	DYB, DYB-LPG, DYB-N	
Renner	FO 516008	8325	163906	Schräg-/Stufenheck, Turnier	
	6½ J x16 H2	205/55R16		1,0i (74/92 kW)/ 1,5i/1,6i (63/77/92/110/134 kW)/ 2,0i (125 kW)/	
	5x108x63,3	215/55R16		1,5 TDCi (70/77/85/88 kW) /2,0 TDCi (85/100/103/110/120 kW)/	
	ET 50			1,6 LPG (86/88 kW)/ 1,6 FlexiFuel (110 kW)	
	€ 75,00	Kegel sw 19 M12 x 1,5/H15			
RDKS	ASC; ASS; CUC; Huf 2.4; Huf 3.4; Huf 3.5; SE1C1; SE1C2; SE2C1; SE2C2; SE1S; SE2S / OE: Schrader 3021				

Focus III				DYB, DYB-LPG, DYB-N		
MAGNA	Tezzo	TZ 656 45 5 08	lichtsilber-lackiert / mattschwarz-lackiert			
	6½ J x16 H2	205/55R16	⊛	ABE		
	5 x 108	215/50R16	⊛	ABE		
	ET 45	215/55R16	⊛	ABE		
RDKS	ASC; ASS; CUC; Huf 2.4; Huf 3.4; Huf 3.5; SE1C1; SE1C2; SE1S; TTC / OE: Schrader 3021			MK 042	TZ	TZ

Focus III				DYB, DYB-LPG, DYB-N		
MAGNA	Interio	IN 706 45 5 08	lichtsilber-lackiert / mattschwarz-lackiert			
	7 J x16 EH2+	205/55R16	⊛	ABE		
	5 x 108	215/55R16		ABE		
	ET 45					
RDKS	ASC; CUC; Huf 2.4; Huf 3.4; Huf 3.5; SE1C1; SE1S / OE: Schrader 3021			MK 042	IN	IN



Focus III				DYB, DYB-LPG, DYB-N		
MAGNA	Celsio	CS 707 47 5 08	lichtsilber-lackiert			
	7 J x17 EH2+	205/50R17	⊛	ABE		
	5 x 108	215/45R17	⊛	ABE		
	ET 47	225/45R17	⊛	ABE		
RDKS	ASC; ASS; CUC; Huf 2.4; Huf 3.4; Huf 3.5; SE1C1; SE1C2; SE1S; TTC / OE: Schrader 3021			MK 042		CS

Fusion			10/02-06/12	JU2	
Stahl	FO 514010	6275	143304	Mini-Van	
	5½ J x14 H2	185/60R14 M+S		1,2-16V (55 kW)/ 1,4i-16V (59 kW)/ 1,6i-16V (74 kW)/	
	4x108x63,3			1,4TDCi (50 kW)/ 1,6 TDCi (66 kW)	
	ET 47,5				
	€ 57,10	Kegel sw 19 M12 x 1,5/H15			
RDKS					

		JU2	10/02-06/12	Fusion	
	Mini-Van	153802	8200	FO 515007	
	1,4i-16V (59 kW)/ 1,6i-16V (74 kW)/ 1,4TDCi (50 kW)	185/60R15		6 J x15 H2	
		195/60R15		4x108x63,3	
	1,2i-16V (55 kW)/ 1,6 TDCi (66 kW)	195/60R15		ET 52,5	
FZG-Schein beachten. Je nach Ausführung unterschiedliche Reifenabmessungen zulässig!		Kegel sw 19 M12 x 1,5/H15		€ 63,40	
RDKS					

		WGR	05/01-06/06	Galaxy I	
	Van	163801		VO 516010	
	2,0i (85 kW)/2,3i 16V (103 kW)/ 1,9TDI (66-110 kW)	195/60R16		6 J x16 H2	
		205/55R16		5x112x57	
	2,0i/ 2,3i/ 2,8 CD V6 24V (150kW)/ 1,9 TDI	215/55R16		ET 53	
2,8 CD V6 24V (150kW) auch 195/60R16 M+S möglich. Bei einige Ausführungen des 2,8 V6 150 kW nur Reinforced Reifen. Nur zulässig an Fahrzeugen mit 16 Zoll Bremse!		Kugel sw 19 M14 x 1,5 x 34		€ 79,70	
RDKS					

		WA6	07/06-06/15	Galaxy II	
	Van	163414	8465	FO 516007	
	1,6i (118 kW)/ 2,0i (107/149 kW)/ 2,3i (118 kW)/ 1,8 TDCi (74/92 kW)/ 2,0 TDCi (85/96/103/120 kW)/ 2,2 TDCi (129 kW)/ 2,0 FlexiFuel (107 kW)	215/60R16		6½ J x16 H2	
				5x108x63,3	
				ET 50	
Bis EGBe e13*2001/116*0185*23		Kegel sw 21 M14 x 1,5/H15		€ 80,30	
RDKS					

		WA6	Galaxy II			
		lichtsilber-lackiert / mattschwarz-lackiert	Tezzo	TZ 656 45 5 08		
			ABE	215/60R16 ❄	6½ J x16 H2	
			ABE	225/55R16 ❄		5 x 108
			ABE	235/55R16		ET 45
MK 070		ASC; ASS; CUC; Huf 2.4; Huf 3.4; Huf 3.5; SE1C1; SE1C2; SE1C2; SE2C2; SE15; SE25; TTC; TTS; OE: VDO S180084730Z				
RDKS						

		WA6	Galaxy II			
		lichtsilber-lackiert	Celsio	CS 707 47 5 08		
			ABE	215/55R17	7 J x17 EH2+	
			ABE	225/50R17		5 x 108
						ET 47
MK 070		ASC; ASS; CUC; Huf 2.4; Huf 3.4; Huf 3.5; SE1C1; SE1C2; SE15; TTC / OE: VDO S180084730Z				
RDKS						

Galaxy III		07/15-	WA6	
Stahl	FO 517004	9001	175304	Van
	7½ J x17 H2	235/55R17		1,5i (118 kW)/ 2,0 TDCi (88/110/132/154 kW)
	5x108x63,3			
	ET 55			
	€ 90,50			Ab EGBE e13*2001/116*0185*24 Nicht 4x4
RDKS	ASC; ASS; CUC; CUS; Huf 2.4; Huf 3.4; Huf 3.5; SE2S / OE: Schrader 3023			Radabbildung in Vorbereitung

Galaxy III		WA6	
MAGMA			
	in Vorbereitung		
RDKS			Radabbildung in Vorbereitung



Ka		02/09-	RU8	
Renner	FL 514026	6315	143694	Schrägheck
	5½ J x14 H2	165/65R14		1,2i (51 kW)/ 1,3 TDCi (55 kW)
	4x98x58	175/65R14		
	ET 35			
	€ 56,50	Kegel sw 17 M12 x 1,25 x 22		
RDKS	CUC; Huf 3.5; SE1C1; SE1C2; SE1S; SE2S			

Ka		RU8	
Celsio		CS 554 35 4 98	lichtsilber-lackiert
MAGMA	5½ J x14 H2	165/65R14 ☼	ABE
	4 x 98	175/65R14 ☼	ABE
	ET 35	185/60R14 ☼	ABE
RDKS	ASC; ASS; Huf 2.4; Huf 3.4; SE1C1; SE1C2; SE1S; TTC; TTS		MK 109 CS 

Ka		02/09-	RU8	
Stahl	FL 515009	8185	154589	Schrägheck
	6 J x15 H2	195/50R15		1,2i (51 kW)/ 1,3 TDCi (55 kW)
	4x98x58			
	ET 40			
	€ 74,00	Kegel sw 17 M12 x 1,25 x 22		
RDKS	ASC; ASS; CUC; Huf 2.4; Huf 3.4; SE1C1; SE1S; TTC; TTS			

		DM2	06/08-12/12	Kuga	
	SUV		163906	8325	FO 516008
	2,5i (147 kW)/ 2,0TDCi (100/120 kW)/ 4x2/ 4x4		235/60R16		6½ J x16 H2 5x108x63,3 ET 50
	Nicht zulässig für Kuga II ab 01/13-		Kegel sw 19 M12 x 1,5/H15		€ 75,00
RDKS					

Renner

		DM2	Kuga I				
		lichtsilber-lackiert / mattschwarz-lackiert	Tezzo	TZ 656 45 5 08			
			ABE	235/60R16 *	6½ J x16 H2		
					5 x 108		
					ET 45		
TZ	TZ	MK 042	ASC; ASS; CUC; Huf 2.4; Huf 3.4; Huf 3.5; SE1C1; SE1C2; SE1S; TTC				
RDKS							



KRONPRINZ
MAGMA

		DM2	Kuga I				
		lichtsilber-lackiert	Celsio	CS 707 47 5 08			
			ABE	215/55R17 *	7 J x17 EH2+		
			ABE	225/55R17 *	5 x 108		
			ABE	235/55R17 *	ET 47		
CS	MK 042	ASC; ASS; CUC; Huf 2.4; Huf 3.4; Huf 3.5; SE1C1; SE1C2; SE1S; TTC					
RDKS							



KRONPRINZ
MAGMA

		DM2	01/13-	Kuga II	
	SUV		163340	9232	FO 616010
	1,5i (110/134 kW)/ 2,0TDCi (88/103/110/120/132 kW)/ 4x4		215/65R16 235/60R16		6½ J x16 H2 5x108x63 ET 50
			Kegel sw 19 M12 x 1,5		€ 79,80
ASC; ASS; CUC; CUS; Huf 2.4; Huf 3.4; Huf 3.5; SE1C1; SE1C2; SE2C2; SE1S; SE2S; TTC; TTS / OE: Schrader 3021					
RDKS					

Stahl



		DM2	Kuga II				
		lichtsilber-lackiert / mattschwarz-lackiert	Tezzo	TZ 656 45 5 08			
			ABE	215/65R16 *	6½ J x16 H2		
			ABE	225/60R16 *	5 x 108		
			ABE	235/60R16 *	ET 45		
TZ	TZ	MK 042	ASC; ASS; CUC; Huf 2.4; Huf 3.4; Huf 3.5; SE1C1; SE1C2; SE1S; TTC / OE: Schrader 3021				
RDKS							



KRONPRINZ
MAGMA

Kuga II				DM2			
MAGNA	Tezzo		TZ 757 45 5 08	lichtsilber-lackiert / mattschwarz-lackiert			
	7½ J x17 H2	215/60R17	☼	ABE			
	5 x 108	225/55R17	☼	ABE			
	ET 45	225/60R17		ABE			
RDKS	ASC; ASS; CUC; Huf 2.4; Huf 3.4; Huf 3.5; SE1C1; SE1C2; SE1S			MK 042	TZ	TZ	

Mondeo II			12/00-05/07	B4Y, B5Y, BWY			
Stahl	FO 516005		9975	163903	Stufenheck, Turnier		
	6½ J x16 H2		205/50R16		1,8i-16V (81/92/96 kW)/ 2,0i-16V (107kW)/ 2,5i V6 (125kW)/3,0i V6 (150kW)/ST 220 (166kW)/ 2,0 TDDi (66 kW)/ 2,0 TDCi (85/96 kW)/ 2,2 TDCi (114 kW)		
	5x108x63,3		205/55R16				
	ET 52,5						
€ 75,50		Kegel sw 19 M12 x 1,5/H15		FZG-Schein beachten, bei einigen Ausführungen ist FO 516005 nur mit 205/55 R16 M+S Bereifung zulässig.			
RDKS							

Mondeo III			06/07-01/15	BA7			
Renner	FO 516008		8325	163906	Fließheck, Stufenheck, Turnier		
	6½ J x16 H2		205/55R16		1,6 Ti-VCT/ 1,8 TDCi		
	5x108x63,3		215/55R16				
	ET 50		215/55R16		2,0i/ 2,2i/ 2,3i/ 2,5i / 1,6 TDCi (85 kW)/ 2,0 TDCi/ 2,2 TDCi/ 2,0 LPG		
€ 75,00		Kegel sw 19 M12 x 1,5/H15		FZG-Schein beachten! Je nach Ausführung sind unterschiedliche Reifenabmessungen vorgeschrieben. Bis EGBE Nachtrag *25			
RDKS	ASC; ASS; CUC; Huf 2.4; Huf 3.4; Huf 3.5; SE1C1; SE1C2; SE2C1; SE2C2; SE1S; SE2S / OE: VDO S180084730Z						



Mondeo III				BA7			
MAGNA	Tezzo		TZ 656 45 5 08	lichtsilber-lackiert / mattschwarz-lackiert			
	6½ J x16 H2	205/55R16	☼	ABE			
	5 x 108	215/55R16	☼	ABE			
	ET 45						
RDKS	ASC; ASS; CUC; Huf 2.4; Huf 3.4; Huf 3.5; SE1C1; SE1C2; SE1S; TTC / OE: VDO S180084730Z			MK 042	TZ	TZ	

Mondeo III				BA7			
MAGNA	Interio		IN 706 45 5 08	lichtsilber-lackiert / mattschwarz-lackiert			
	7 J x16 EH2+	205/55R16	☼	ABE			
	5 x 108	215/55R16	☼	ABE			
	ET 45						
RDKS	ASC; CUC; Huf 2.4; Huf 3.4; Huf 3.5; SE1C1; SE1S			MK 042	IN	IN	

BA7, BA7-HEV		02/15-	Mondeo IV	
	Stufenheck	163906	8325	FO 516008
	1,0i (92 kW) / 1,5i (118 kW) / 2,0i (149/177 kW) / 1,5 TDCi (88 kW) / 1,6 TDCi (85 kW) / 2,0 TDCi (110/132 kW) / 2,0 Hybrid (103 kW)	215/60R16		6½ J x16 H2 5x108x63,3 ET 50
Ab EGBE Nachtrag *26		Kegel sw 19 M12 x 1,5/H15		€ 75,00
		ASC; ASS; CUC; Huf 2.4; Huf 3.4; Huf 3.5; SE1C1; SE1C2; SE2C1; SE2C2; SE15; SE25 / OE: Schrader 3021		RDKS

BA7		Mondeo IV	
Radabbildung in Vorbereitung			in Vorbereitung
		RDKS	



WA6		06/06-06/15	S-Max I	
	Sportvan	163414	8465	FO 516007
	1,6i (118 kW) / 2,0i (107/149 kW) / 2,3i (118 kW) / 2,5i (162 kW) / 1,8 TDCi (74/92 kW) / 2,0 TDCi (85/96/103/120 kW) / 2,2 TDCi (129 kW) / 2,0 FlexiFuel (107 kW)	215/60R16		6½ J x16 H2 5x108x63,3 ET 50
Bis EGBE e13*2001/116*0185*23		Kegel sw 21 M14 x 1,5/H15		€ 80,30
		ASC; ASS; CUC; Huf 2.4; Huf 3.4; Huf 3.5; SE1C1; SE1C2; SE2C1; SE2C2; SE15; SE25; TTC; TTS / OE: VDO S180084730Z		RDKS

WA6		S-Max I	
		lichtsilber-lackiert / mattschwarz-lackiert	
		Tezzo	TZ 656 45 5 08
TZ	TZ	ABE	215/60R16 ❄
		ABE	225/55R16 ❄
		ABE	235/55R16
MK 070		ASC; ASS; CUC; Huf 2.4; Huf 3.4; Huf 3.5; SE1C1; SE1C2; SE15; TTC / OE: VDO S180084730Z	
		RDKS	

WA6		S-Max I	
	lichtsilber-lackiert		Celsio
			CS 707 47 5 08
CS	MK 070	ABE	215/55R17
		ABE	225/50R17
		7 J x17 EH2+ 5 x 108 ET 47	
		ASC; ASS; CUC; Huf 2.4; Huf 3.4; Huf 3.5; SE1C1; SE1C2; SE15; TTC / OE: VDO S180084730Z	
		RDKS	





S-Max II			07/15-	WA6	
Stahl	FO 517004	9001	175304	Sportvan	Radabbildung in Vorbereitung
	7½ J x17 H2	235/55R17		1,5i (118 kW)/ 2,0TDCi (88/110/132/154 kW)	
	5x108x63,3				
	ET 55				
	€ 90,50			Ab EGBE e13*2001/116*0185*24 Nicht 4x4	
RDKS	ASC; ASS; CUC; CUS; Huf 2.4; Huf 3.4; Huf 3.5; SE2S / OE: Schrader 3023				

S-Max II			WA6	
MAGNUM	in Vorbereitung			Radabbildung in Vorbereitung
RDKS				

Street Ka			RL2		
MAGNUM	Interio	IN 604 38 4 08	lichtsilber-lackiert / mattschwarz-lackiert		 
	6 J x14 H2	155/65R14 M+S ❄	ABE		
	4 x 108	165/65R14 M+S	ABE		
	ET 38				
RDKS	ASC; ASS; Huf 2.4; Huf 3.4; SE1C1; SE1C2; SE1S; TTC; TTS		MK 041	IN	IN

Touneo Connect		03/03-12/13	PH2, PJ2		
Stahl	FO 615006	8525	154508	Kombi	
	6 J x15 H2	195/65R15		1,8i (85 kW)/ 1,8TDCi (66/81 kW)	
	5x108x63,3				
	ET 52,5				
	€ 71,30	Kegel sw 19 M12 x 1,5/H15			
RDKS					

Touneo Connect		01/14-	PJ2, PU2		
Stahl	FO 616010	9232	163340	Kombi	
	6½ J x16 H2	205/60R16		1,0 EcoBoost (74 kW)/ 1,6 EcoBoost (110 kW)/	
	5x108x63	215/55R16		1,5TDCi (55/74/88 kW)/ 1,6TDCi (55/70/85 kW)	
	ET 50				
	€ 79,80	Kegel sw 19 M12 x 1,5			
RDKS	ASC; ASS; CUC; CUS; Huf 2.4; Huf 3.4; Huf 3.5; SE1C1; SE1C2; SE2C2; SE1S; SE2S; TTC; TTS / OE: Schrader 3021				

		JU2	03/14-	Tourneo Courier		
	Kombi	154636	5005	FO 615010		
	1,0 EcoBoost (74 kW) / 1,5 TDCi (55 kW) / 1,6 TDCi (70 kW)	185/60R15		6 J x15 H2		
		195/60R15		4x108x63		
				ET 37,5		
				€ 71,30		
		Kegel sw 19 M12 x 1,5				Stahl
		ASC; ASS; CUC; CUS; Huf 2.4; Huf 3.4; Huf 3.5; SE1C2; SE2C2; SE1S; SE2S; TTC; TTS / OE: Schrader 3021				
						RDKS
		FAC	12/12-	Tourneo Custom		
	Bus	154545	8337	FO 615009		
	2,2 TDCi (74/92/114 kW)	215/65R15C		6½ J x15 H2		
				5x160x65		
				ET 60		
				€ 87,60		
		ASC; ASS; CUC; CUS; Huf 2.4; Huf 3.4; Huf 3.5; SE1C1; SE1C2; SE2C2; SE1S; SE2S; TTC; TTS / OE: Schrader 3020				Stahl
						RDKS
		FAC	12/12-	Tourneo Custom		
	Bus	163337	9118	FO 616009		
	2,2 TDCi (74/92/114 kW)	215/65R16C		6½ J x16 H2		
				5x160x65		
				ET 60		
				€ 95,00		
		ASC; ASS; CUC; CUS; Huf 2.4; Huf 3.4; Huf 3.5; SE1C1; SE1C2; SE2C2; SE1S; SE2S; TTC; TTS / OE: Schrader 3020				Stahl
						RDKS
		F*BEY/DEY/DFY/DGY/SEY/SFY/SGY/ZEY/AFY/AEY/AGY/NFY		01/01-05/06	Transit	
	Bus/Kasten	154507	8505	FO 615005		
	FT260/280/300/2,0TD/2,0TDE	195/70R15		5½ J x15 H2		
				5x160x65		
				ET 60		
				€ 86,60		
		Typ: F*BEY/DEY/DFY/DGY/SEY/SFY/SGY/ZEY/AFY/AEY/AGY/NFY FO 615005 nur für FZG mit Frontantrieb!				Stahl
		Flachb. sw 21 M14 x 2				
						RDKS
		F*ACY/BEY/DEY/DFY/DGY/SEY/SFY/SGY/ZEY		10/02-05/06	Transit	
	Bus/Kasten/Pritsche	163313	9597	FO 616006		
	2,0 D (55/63/74/92 kW)	205/65R16		5½ J x16 H2		
		205/75R16		5x160x65		
		215/75R16		ET 56		
				€ 94,00		
		Für Fahrzeuge mit Singlebereifung (V 184). FZG-Schein beachten. Einige Ausführungen nur 205/65R16 zulässig.				Stahl
		Flachb. sw 21 M14 x 2				
						RDKS

Transit		06/06-04/14	F*AE6/AF6/AG6/BE6/DE6/DF6/DG6/NF6/SE6/SF6/SG6/ZE6
Stahl	FO 615005	8505	154507
	5½ J x15 H2	195/70R15	
	5x160x65 ET 60		
€ 86,60		Flachb. sw 21 M14 x 2	
RDKS		FZG-Schein muss unbedingt beachtet werden: Je nach Ausführung und Motorisierung sind unterschiedliche Reifenabmessungen vorgeschrieben. Bei einigen Ausführungen ist ausschließlich 16 Zoll zulässig. Für Fahrzeuge mit Frontantrieb.	



Transit		06/06-04/14	F*AD6/MA6/MB6/MC6/MD6/NB6/NC6/ND6
Stahl	FO 616007	9037	163314
	5 J x16 H2	185/75R16	
	6x180x138 ET 107	195/75R16	
€ 101,40		Flachb. sw 21 M14 x 2	
RDKS		Für Zwillingbereifung. Auch Vorderachse. FZG-Schein und Unterlagen beachten. Je nach Fahrzeugausführung unterschiedliche Rad-/Reifenkombinationen zulässig.	



Transit		06/06-04/14	F*AA6/AB6/AC6/AD6/AE6/AF6/AG6/BE6/DA6/DB6/DC6/DE6/DF6/DG6/MA6/MB6/MC6/MD6/ME6/MF6/MG6/MH6/NB6/NC6/ND6/NF6/SA6/SB6/SC6/SE6/SF6/SG6/ZE6
Stahl	FO 616006	9597	163313
	5½ J x16 H2	185/75R16	
	5x160x65	205/75R16	
	ET 56	215/75R16	
€ 94,00		Flachb. sw 21 M14 x 2	
RDKS		FZG-Schein muss unbedingt beachtet werden: Je nach Ausführung und Motorisierung sind unterschiedliche Reifenabmessungen vorgeschrieben. Einige Ausführungen des 2,2 TDCi nur 205/65R16. Für Fahrzeuge mit Heckantrieb. Einige auch 205/65R16.	









Transit		05/14-	FCD
Stahl	FO 615009	8337	154545
	6½ J x15 H2	215/65R15C	
	5x160x65 ET 60		
€ 87,60			
RDKS		Einige Ausführungen nur 16 Zoll! ASC; ASS; CUC; CUS; Huf 2.4; Huf 3.4; Huf 3.5; SE1C1; SE1C2; SE2C2; SE1S; SE2S; TTC; TTS / OE: Schrader 3020	



Transit		05/14-	FBD, FCD, FDD, FED, FFD
Stahl	FO 616009	9118	163337
	6½ J x16 H2	215/65R16C	
	5x160x65	235/65R16C	
	ET 60		
€ 95,00			
RDKS		FZG-Schein muss unbedingt beachtet werden: Je nach Ausführung und Motorisierung sind unterschiedliche Reifenabmessungen vorgeschrieben.	





		FBD, FCD, FDD, FED, FFD	05/14-	Transit	
	Bus/Kasten/Pritsche	163345	9197	FO 616011	Stahl
	2,2 TDCi (74/92/114 kW)	195/75R16C		6 J x16 H2 6x180x138,8 ET 109,5	
	Rad für Zwillingbereifung. Auch Vorderachse. FZG-Schein muss unbedingt beachtet werden: Je nach Ausführung und Motorisierung sind unterschiedliche Reifenabmessungen vorgeschrieben.			€ 101,40	RDKS
		PU2, PT2	03/03-12/13	Transit Connect	
	Kasten	154508	8525	FO 615006	Stahl
	1,8i (85 kW) / 1,8 TDDi (55 kW) / 1,8 TDCi (66/81 kW)	195/65R15		6 J x15 H2 5x108x63,3 ET 52,5	
			Kegel sw 19 M12 x 1,5/H15	€ 71,30	RDKS
		PJ2, PU2	01/14-	Transit Connect	
	Kasten	163340	9232	FO 616010	Stahl
	1,0 EcoBoost (74 kW) / 1,6 EcoBoost (110 kW) / 1,5 TDCi (74/88 kW) / 1,6 TDCi (55/70/85 kW)	205/60R16 215/55R16		6½ J x16 H2 5x108x63 ET 50	
			Kegel sw 19 M12 x 1,5	€ 79,80	RDKS
			ASC; ASS; CUC; CUS; Huf 2.4; Huf 3.4; Huf 3.5; SE1C1; SE1C2; SE2C2; SE1S; SE2S; TTC; TTS / OE: Schrader 3021		
		JN8	03/14-	Transit Courier	
	Kasten	154636	5005	FO 615010	Stahl
	1,0 EcoBoost (74 kW) / 1,5 TDCi (55 kW) / 1,6 TDCi (70 kW)	185/60R15 195/60R15		6 J x15 H2 4x108x63 ET 37,5	
			Kegel sw 19 M12 x 1,5	€ 71,30	RDKS
			ASC; ASS; CUC; CUS; Huf 2.4; Huf 3.4; Huf 3.5; SE1C2; SE2C2; SE1S; SE2S; TTC; TTS / OE: Schrader 3021		
		FCC	12/12-	Transit Custom	
	Kombi, Kasten	154545	8337	FO 615009	Stahl
	2,2 TDCi (74/92/114 kW)	215/65R15C		6½ J x15 H2 5x160x65 ET 60	
				€ 87,60	RDKS
			ASC; ASS; CUC; CUS; Huf 2.4; Huf 3.4; Huf 3.5; SE1C1; SE1C2; SE2C2; SE1S; SE2S; TTC; TTS / OE: Schrader 3021		

Transit Custom		12/12-	FCC	
Stahl	FO 616009	9118	163337	Kombi, Kasten
	6½ J x16 H2	215/65R16C		2,2 TDCi (74/92/114 kW)
	5x160x65			
	ET 60			
	€ 95,00			
RDKS	ASC; ASS; CUC; CUS; Huf 2.4; Huf 3.4; Huf 3.5; SE1C1; SE1C2; SE2C2; SE1S; SE2S; TTC; TTS / OE: Schrader 3021			

HONDA



Accord		08/07-06/15	CU1, CU3, CW1, CW3	
Stahl	HO 516007	9527	163452	Stufenheck
	6½ J x16 H2	205/60R16		2,0i-VTEC (115 kW)
	5x114,3x64	215/60R16		2,2i-DTEC
	ET 50			
	€ 90,30	Kugel sw 19 M12 x 1,5/H17		
RDKS	ASC; ASS; CUC; CUS; Huf 2.4; Huf 3.4; Huf 3.5; SE1C1; SE1C2; SE2C2; SE1S; SE2S / OE: VDO S180052059Z			



Accord		CU1, CU3, CW1, CW3				
MAGMA	Celsio	CS 656 40 5 14	lichtsilber-lackiert			
	Tezzo	TZ 656 40 5 14	lichtsilber-lackiert / mattschwarz-lackiert			
	6½ J x16 H2	205/60R16	* ABE			
	5 x 114,3	215/55R16	* ABE			
	ET 40	215/60R16	* ABE			
RDKS	Celsio: ASC; ASS; CUC; Huf 2.4; Huf 3.4; Huf 3.5; SE1C1; SE1C2; SE1S; TTC; TTS Tezzo: ASC; ASS; CUC; Huf 2.4; Huf 3.4; Huf 3.5; SE1C1; SE1C2; SE1S; TTC / OE: VDO S180052059Z		MK 044		CS	TZ

Civic		03/06-01/12	FK1, FK2, FK3, FN1, FN3, FN4	
Stahl	HO 516006	8005	163451	Schrägheck
	6½ J x16 H2	205/55R16		1,4i (61/73 kW) / 1,8i (103 kW) / 2,2 CDTi (103 kW) / Type-5
	5x114,3x64			
	ET 55			
	€ 83,50	Kugel sw 19 M12 x 1,5/H17		
RDKS				

		FK1, FK2, FK3, FN1, FN2, FN3, FN4		Civic	
	lichtsilber-lackiert		Celsio	CS 656 50 5 14	
		ABE	205/55R16 * 225/50R16	6½ J x16 H2 5 x 114,3 ET 50	
	MK 044		ASC; ASS; CUC; Huf 2.4; Huf 3.4; Huf 3.5; SE1C1; SE1C2; SE1S; TTC; TTS		RDKS
					MAGNA

		FK1, FK2, FK3	02/12-	Civic		
	Schrägheck	163317	8067	HO 516009		
	1,4i (73 kW) / 1,8i (104 kW) / 2,2 D (110 kW)	205/55R16		6½ JJ x16 H2 5x114,3x64 ET 45		
	MK 044		Kugel sw 19 M12 x 1,5/H17		€ 83,50	
			ASC; ASS; CUC; CUS; Huf 2.4; Huf 3.4; Huf 3.5; SE1C1; SE1C2; SE1S; SE2S		RDKS	

		FK1, FK2, FK3		Civic (Modelljahr 2012)		
		lichtsilber-lackiert		Celsio	CS 656 40 5 14	
		lichtsilber-lackiert / mattschwarz-lackiert		Tezzo	TZ 656 40 5 14	
			ABE	205/55R16	6½ J x16 H2 5 x 114,3 ET 40	
		MK 044		Celsio: ASC; ASS; CUC; Huf 2.4; Huf 3.4; Huf 3.5; SE1C1; SE1C2; SE1S; TTC; TTS Tezzo: ASC; ASS; CUC; Huf 2.4; Huf 3.4; Huf 3.5; SE1C1; SE1C2; SE1S; TTC		RDKS

		RES, RE6 ab Nachtrag 6		CR-V		
		lichtsilber-lackiert / mattschwarz-lackiert		Tezzo	TZ 757 40 5 14	
		Auflagen beachten!	TÜV	225/65R17 * 235/60R17 *	7½ J x17 H2 5 x 114,3 ET 40	
		MK 044		ASC; ASS; CUC; Huf 2.4; Huf 3.4; Huf 3.5; SE1C1; SE1C2; SE1S		RDKS
						MAGNA

		ZF1	CR-Z			
		lichtsilber-lackiert		Celsio	CS 656 40 5 14	
		lichtsilber-lackiert / mattschwarz-lackiert		Tezzo	TZ 656 40 5 14	
			ABE	195/50R16 * 195/55R16 205/50R16	6½ J x16 H2 5 x 114,3 ET 40	
		MK 044		Celsio: ASC; ASS; CUC; Huf 2.4; Huf 3.4; Huf 3.5; SE1C1; SE1C2; SE1S; TTC; TTS Tezzo: ASC; ASS; CUC; Huf 2.4; Huf 3.4; Huf 3.5; SE1C1; SE1C2; SE1S; TTC		RDKS

HR-V		09/15-	RU	
Stahl	INFO		SUV	Radabbildung in Vorbereitung
			1,5i (96 kW)/ 1,6 D (88 kW)	
RDKS				

HR-V		RU	
KRONPRINZ MAGNUM	in Vorbereitung		Radabbildung in Vorbereitung
RDKS			

Insight		04/09-	ZE2	
Stahl	HO 515016	7805	154615	
	5½ J x15 H2	175/65R15	Schrägheck	
4x100x56		1,3 (65 kW)		
ET 45				
RDKS	€ 72,40	Kugel sw 19 M12 x 1,5/H17		
	ASC ; ASS ; CUC ; CUS ; Huf 2.4 ; Huf 3.4 ; Huf 3.5 ; SE1C1 ; SE2C2 ; SE1S ; SE2S ; TTC			

Jazz		03/04-10/08	GD1, GD5, GE2, GE3	
Stahl	HO 514012	6885	143719	
	5½ JJ x14 H2	175/65R14	Schrägheck	
4x100x56		1,3i (57 kW)/ 1,4i-DSi (61 kW)		
ET 45		Ab Modelljahr 2004 zulässig.		
RDKS	€ 68,20	Kugel sw 19 M12 x 1,5/H17		

Jazz		11/08-08/15	GG1, GG2, GG3, GP1	
Stahl	HO 515016	7805	154615	
	5½ J x15 H2	175/65R15	Schrägheck	
4x100x56		1,2i (66 kW)/ 1,4i (73 kW)/ 1,4 Hybrid (65 kW)		
ET 45				
RDKS	€ 72,40	Kugel sw 19 M12 x 1,5/H17		
	ASC ; ASS ; CUC ; CUS ; Huf 2.4 ; Huf 3.4 ; Huf 3.5 ; SE1C1 ; SE2C2 ; SE1S ; SE2S ; TTC / OE: Schrader 4064			

		GK	09/15-	Jazz	
Radabbildung in Vorbereitung	Schrägheck	154647	4025	HO 515019	
	1,3i (75 kW)			5½ J x15 H2	
	Vorläufige Daten, Änderungen möglich!			4x100x56	
				ET 45	
				€ 72,90	
RDKS					

		LC	01/00-05/06	Accent	
	Schrägheck	133575	4375	HY 513007	
	1,3 (55/63 kW)/1,5i (66 kW)	175/70R13		5 J x13 CH	
		Kegel sw 21 M12 x 1,5/H17		4x100x54	
				ET 46	
				€ 63,90	
RDKS					

		LC	01/00-05/06	Accent	
	Schrägheck	143773	5220	HY 514005	
	1,3 (55/63 kW)/1,5i (66 kW)	185/60R14		5 J x14 CH	
		Kegel sw 21 M12 x 1,5/H17		4x100x54	
				ET 46	
				€ 71,90	
RDKS					

		MC, MCT	06/06-	Accent	
	Schrägheck	143777	7230	KI 514005	
	1,4i (71 kW)/ 1,6i (82 kW)/ 1,5 CRDi (81 kW)	175/70R14		5½ J x14 H2	
		185/65R14		4x100x54	
				ET 46	
				€ 72,90	
RDKS					



Atos			02/01-02/04	MX	
Stahl	HY 513007	4375	133575	Mini-Van	
	5 J x13 CH	155/70R13		1,0i (43 kW)	
	4x100x54	175/60R13			
	ET 46				
	€ 63,90	Kegel sw 21 M12 x 1,5/H17			
RDKS					

Atos			03/04-02/08	MXI	
Stahl	HY 513007	4375	133575	Mini-Van	
	5 J x13 CH	175/60R13		1,1 (43 kW)	
	4x100x54				
	ET 46				
	€ 63,90	Kegel sw 21 M12 x 1,5/H17			
RDKS					

Getz			09/02-	TB	
Stahl	HY 513007	4375	133575	Schrägheck	
	5 J x13 CH	155/80R13		1,1 (46 kW)	
	4x100x54				
	ET 46				
	€ 63,90	Kegel sw 21 M12 x 1,5/H17			
RDKS					

Getz			09/02-	TB	
Stahl	HY 514005	5220	143773	Schrägheck	
	5 J x14 CH	165/65R14		1,1 (46 kW)/ 1,3 GLS (60 kW)/ 1,4i (71 kW)/ 1,5 CRDi GLS (60 kW)	
	4x100x54	175/65R14			
	ET 46	175/65R14		1,6 GLS (77 kW)	
	€ 71,90	Kegel sw 21 M12 x 1,5/H17		Einige Ausführungen nur 175/65R14.	
RDKS					

Getz			01/07-	TBI	
Stahl	HY 514005	5220	143773	Schrägheck	
	5 J x14 CH	165/65R14		1,1i (49 kW)/ 1,4i (71 kW)	
	4x100x54	175/65R14		1,6i (78 kW)	
	ET 46				
	€ 71,90	Kegel sw 21 M12 x 1,5/H17		Einige Ausführungen nur 5½ x 14 ET46.	
RDKS					

		TQ	06/08-	H1-Cargo		
	Kasten	163467	9207	HY 616001		
	2,5 CRDi (85/125 kW)	215/70R16C		6½ J x16 CH 6x139,7x92,5 ET 56		
		Kegel sw 21 M12 x 1,5/H17		€ 105,10		
		ASS; CUC; CUS; Huf 2.4; Huf 3.4; Huf 3.5; SE1C2; SE2C2; SE1S; SE2S / OE: VDO				RDKS
		TQ	11/07-	H1-Travel		
	Van	163467	9207	HY 616001		
	2,5 CRDi (125 kW)	215/70R16C		6½ J x16 CH 6x139,7x92,5 ET 56		
		Kegel sw 21 M12 x 1,5/H17		€ 105,10		
		ASS; CUC; CUS; Huf 2.4; Huf 3.4; Huf 3.5; SE1C2; SE2C2; SE1S; SE2S / OE: VDO				RDKS
		EU(B), EU(V)	06/15-	H350		
Radabbildung in Vorbereitung	Transporter	163438	6503	HY 616002		
	2,2 CRDi (125 kW)/ 2,5 CRDi (110/125 kW)	235/65R16C		6½ J x16 H2 6x139,7x92,3 ET 50		
				€ 105,10		
						RDKS
		PA	03/08-11/13	i10		
	Schrägheck	133579	2490	KI 513003		
	1,0i (49/51 kW)/ 1,1i (49/51kW)/ 1,2i (63 kW)/ 1,3i (57 kW)	155/70R13		4.00 B x13 H2 4x100x54 ET 46		
		Kegel sw 21 M12 x 1,5/H17		€ 62,90		
						RDKS
		PA	03/08-11/13	i10		
	Schrägheck	143778	5490	KI 514004		
	1,0i (49 kW)/ 1,1i (49/51kW)/ 1,2i (63 kW)/ 1,3i (57 kW)	165/60R14	5 J x14 H2 4x100x54 ET 46			
		175/60R14				
	1,1 CRDi (55 kW)	175/60R14	€ 71,90			
Fahrzeugschein beachten. Je nach Ausführung unterschiedliche Reifenabmessungen vorgeschrieben!		Kegel sw 21 M12 x 1,5/H17				
						RDKS

i10		12/13-	IA	
Stahl	HY 513009	4275	133405	Schrägheck
	4½ J x13 H2	155/70R13		1,0i (49 kW)
	4x100x54 ET 35 € 59,90			
RDKS	ASC ; ASS ; CUC ; CUS ; Huf 2.4 ; Huf 3.4 ; Huf 3.5 ; SE1C1 ; SE1C2 ; SE1S ; SE2S ; TTC / TTS / OE: Schrader 3059			

i10		12/13-	IA	
Stahl	HY 514010	5335	143608	Schrägheck
	5½ J x14 H2	175/65R14		1,0i (49 kW) / 1,2i (64kW) / 1,0 LPG (49 kW)
	4x100x54 ET 47 € 63,50			
RDKS	ASC ; ASS ; CUC ; CUS ; Huf 2.4 ; Huf 3.4 ; Huf 3.5 ; SE1C2 ; SE2C2 ; SE1S ; SE2S ; TTC / OE: Schrader 3059			

i20		01/09-12/14	PB	
Stahl	HY 514008	6675	143774	3-Türer
	5 J x14 CH	175/70R14		1,2i (57 kW) / 1,4i (74 kW) / 1,6i (93 kW)
	4x100x54 ET 45 € 69,20			1,4D (54/66 kW) / 1,6D (85/94 kW)
RDKS	ASS ; CUS ; Huf 3.5 ; SE1S ; SE2S			In Indien (IND) produzierte Fahrzeuge.

i20		01/09-12/14	PB	
Stahl	HY 515013	7405	154674	3-Türer
	5½ J x15 H2	185/60R15		1,2i (57 kW) / 1,4i (74 kW) / 1,6i (93 kW)
	4x100x54 ET 51 € 72,40			1,4D (54/66 kW) / 1,6D (85/94 kW)
RDKS	Kegel sw 21 M12 x 1,5/H17			In Indien (IND) produzierte Fahrzeuge.
RDKS	ASC ; ASS ; CUC ; CUS ; Huf 2.4 ; Huf 3.4 ; Huf 3.5 ; SE2C2 ; SE2S ; TTC / OE: VDO S180084710Z			



i20		05/10-12/14	PBT	
Stahl	HY 514009	6625	143786	5-Türer
	5½ J x14 H2	175/70R14		1,2i (57 kW) / 1,4i (74 kW) / 1,6i (93 kW)
	4x100x54 ET 46 € 69,70			1,4D (55 kW) / 1,6D (94 kW)
RDKS	Kegel sw 21 M12 x 1,5/H17			In der Türkei (TR) produzierte Fahrzeuge.
RDKS	ASC ; ASS ; CUC ; CUS ; Huf 2.4 ; Huf 3.4 ; Huf 3.5 ; SE1C1 ; SE1C2 ; SE2S / OE: VDO S180084710Z			

		PBT	05/10-12/14	i20	
	5-Türer	154677	7770	HY 515016	
	1,2i (57 kW)/ 1,4i (74 kW)/ 1,6i (93 kW) 1,4D (55 kW)/ 1,6D (94 kW)	185/60R15		6 J x15 H2 4x100x54 ET 52	
In der Türkei (TR) produzierte Fahrzeuge.		Kegel sw 21 M12 x 1,5/H17		€ 72,90	
		ASC; ASS; CUC; CUS; Huf 2.4; Huf 3.4; Huf 3.5; SE1C1; SE1S; SE2S; TTC / OE: VDO S180084710Z		RDKS	

		GB	01/15-	i20 II	
	Schrägheck	154679	5015	HY 515020	
	1,2i (55/62 kW)/ 1,4i (74 kW)/ 1,1 CRDi (55 kW)/ 1,4 CRDi (66 kW)	185/65R15		6 J x15 CH 4x100x54 ET 47	
				€ 72,90	
		ASC; ASS; CUC; CUS; Huf 2.4; Huf 3.4; Huf 3.5; SE1C1; SE1C2; SE2C2; SE2S; TTC / OE: Schrader 3060		RDKS	



		FD	08/07-02/12	i30 / i30cw	
	Steilheck, Kombi	154673	7475	HY 515012	
	1,4i (77/80 kW)/ 1,6i (90/93 kW)/ 1,6 CRDi (66/85 kW)/ 1,4 LPG (76 kW)/ 1,6 LPG (88 kW)	185/65R15 195/65R15		5½ J x15 CH 5x114,3x67 ET 47	
Nur für in Korea (ROK) produzierte Fahrzeuge!		Kegel sw 21 M12 x 1,5/H17		€ 72,40	
				RDKS	

		FDH	12/08-02/12	i30 / i30cw	
	Steilheck, Kombi	154695	8077	KI 515006	
	1,4i (77/80 kW)/ 1,6i (90/93 kW)/ 1,6 CRDi (66/85 kW)/ 1,4 LPG (76 kW)/ 1,6 LPG (88 kW)	185/65R15 195/65R15		5½ J x15 CH 5x114,3x67 ET 47	
Nur für in Tschechien (CZ) produzierte Fahrzeuge!		Kegel sw 21 M12 x 1,5/H17		€ 72,40	
				RDKS	

		FD, FDH, FDHG	i30 / i30cw	
		lichtsilber-lackiert / mattschwarz-lackiert	Seismo	SO 605 45 5 14
		lichtsilber-lackiert / mattschwarz-lackiert	Interio	IN 605 45 5 14
		ABE	185/65R15 ❄	6 J x15 H2
		ABE	195/65R15 ❄	
		ABE	205/60R15 ❄	5 x 114,3
		MK 047		ET 45
		Seismo: ASC; ASS; Huf 2.4; Huf 3.4; SE1C1; SE1C2; SE1S; TTC / OE: VDO S180014820Z Interio: ASC; ASS; CUS; Huf 2.4; Huf 3.4; SE1C1; SE1C2; SE1S; TTC; TTS / OE: VDO S180014820Z		RDKS

i30 / i30cw			08/07-02/12	FD	
Stahl	KI 516003	7790	163471	Steilheck, Kombi	
	6 J x16 CH	205/55R16		1,4i (77/80 kW) / 1,6i (90/93 kW) / 2,0i (105 kW) /	
	5x114,3x67			1,6 CRDi (66/85 kW) / 2,0 CRDi (100/103 kW) /	
	ET 51			1,4 LPG (76 kW) / 1,6 LPG (88 kW) / 2,0 LPG (100 kW)	
	€ 83,50	Kegel sw 21 M12 x 1,5/H17		Nur für in Korea (ROK) produzierte Fahrzeuge!	
RDKS					

i30 / i30cw			12/08-02/12	FDH	
Stahl	HY 516007	9617	163468	Steilheck, Kombi	
	6 J x16 H2	205/55R16		1,4i (77/80 kW) / 1,6i (90/93 kW) / 2,0i (105 kW) /	
	5x114,3x67			1,6 CRDi (66/85 kW) / 2,0 CRDi (100/103 kW) /	
	ET 50			1,4 LPG (76 kW) / 1,6 LPG (88 kW) / 2,0 LPG (100 kW)	
	€ 83,50	Kegel sw 21 M12 x 1,5/H17		Nur für in Tschechien (CZ) produzierte Fahrzeuge!	
RDKS					



i30 / i30cw			FD, FDH, FDHG				
MAGNNA	Celsio	CS 656 40 5 14		lichtsilber-lackiert			
	Tezzo	TZ 656 40 5 14		lichtsilber-lackiert / mattschwarz-lackiert			
	6½ J x16 H2	195/60R16	☼	ABE			
	5 x 114,3	205/55R16	☼	ABE			
	ET 40						
RDKS						CS	TZ
			Celsio: ASC; ASS; CUC; Huf 2.4; Huf 3.4; Huf 3.5; SE1C1; SE1C2; SE1S; TTIC; TTS / OE VDO S180014820Z Tezzo: ASC; ASS; CUC; Huf 2.4; Huf 3.4; Huf 3.5; SE1C1; SE1C2; SE1S; TTC / OE VDO S180014820Z		MK 047		



i30 / i30cw			03/12-	GDH		
Stahl	HY 515018	8147	154524	Steilheck, Kombi, Coupé		
	6 J x15 CH	195/65R15		1,4i (73/74 kW) / 1,6i (88/99 kW) /		
	5x114,3x67			1,4 CRDi (66 kW) / 1,6 CRDi (81/94/100 kW)		
	ET 46					
	€ 72,90	Kegel sw 21 M12 x 1,5/H17		Einige Ausführungen nur 16 Zoll!		
RDKS						
			ASC; ASS; CUC; CUS; Huf 2.4; Huf 3.4; Huf 3.5; SE1S; SE2S; TTC; TTS / OE: VDO S180052092Z			

i30 / i30cw			03/12-	GDH		
Stahl	HY 516011	9147	163318	Steilheck, Kombi, Coupé		
	6½ J x16 CH	205/55R16		1,4i (73/74 kW) / 1,6i (88/99 kW) /		
	5x114,3x67			1,4 CRDi (66 kW) / 1,6 CRDi (81/94 kW)		
	ET 51					
	€ 84,00	Kegel sw 21 M12 x 1,5/H17				
RDKS						
			ASC; ASS; CUC; CUS; Huf 2.4; Huf 3.4; Huf 3.5; SE1C1; SE1C2; SE2C2; SE1S; SE2S / OE: VDO S180052092Z			

		GDH	i30 / i30cw	
		lichtsilber-lackiert	Celsio	CS 656 50 5 14
		ABE	195/55R16 * 205/55R16	6½ J x16 H2 5 X 114,3
		ABE	215/50R16 *	ET 50
CS	MK 047	ASC; ASS; CUC; Huf 2.4; Huf 3.4; Huf 3.5; SE1C1; SE1C2; SE1S; TTC; TTS		RDKS

		VF	09/11-	i40 / i40cw	
	Stufenheck, Kombi	163474	9317	HY 516010	Stahl
	1,6i (99 kW) / 2,0i (130 kW) / 1,7D (85/100 kW)	205/60R16		7 J x16 H2 5x114,3x67 ET 40	
		Kegel sw 21 M12 x 1,5/H17		€ 86,10	
		ASC; ASS; CUC; Huf 2.4; Huf 3.4; Huf 3.5; SE1C1; SE2C2; SE2S / OE: TRW 52933-3V600		RDKS	



		VF	i40 / i40cw		
		lichtsilber-lackiert / mattschwarz-lackiert	Interio	IN 706 45 5 14	
			ABE	205/60R16 * 225/55R16	7 J x16 EH2+ 5 X 114,3
					ET 45
IN	MK 047	ASC; CUC; Huf 2.4; Huf 3.4; Huf 3.5; SE1C1; SE1S		RDKS	

		VF	i40 / i40cw		
		lichtsilber-lackiert / mattschwarz-lackiert	Tezzo	TZ 757 40 5 14	
			ABE	205/55R17 215/50R17	7½ J x17 H2 5 x 114,3
					ET 40
TZ	MK 047	ASC; ASS; CUC; Huf 2.4; Huf 3.4; Huf 3.5; SE1C1; SE1C2; SE1S		RDKS	

		JC	10/10-	ix20	
	Mini-Van	154678	8503	HY 515017	Stahl
	1,4i (66/ 92 kW) / 1,4 CRDi (66 kW)	195/65R15		6 J x15 H2 5x114,3x67 ET 48	
	KI 515009 kann nicht verwendet werden!	Kegel sw 21 M12 x 1,5/H17		€ 72,90	
		ASC; ASS; CUC; CUS; Huf 2.4; Huf 3.4; Huf 3.5; SE1C1; SE1C2; SE2C2; SE1S; SE2S; TTC / OE: VDO S180052092Z		RDKS	



ix35			03/10-08/13	EL, ELH	
Stahl	HY 516009	8756	163469	SUV	
	6½ J x16 H2	215/70R16		1,6i (99 kW)/ 2,0i (120 kW)/ 2,0 CRDi (100/135 kW)/ 2WD/ 4WD	
	5x114,3x67 ET 45				
€ 86,10		Kegel sw 21 M12 x 1,5/H17		Sonderrad mit ABE!	
RDKS					

ix35 (Facelift)			09/13-08/15	ELH	
Stahl	HY 516012	8758	163425	SUV	
	6½ J x16 H2	215/70R16		1,6i (99 kW)/ 2,0i (122 kW)/ 1,7 CRDi (85 kW)/ 2,0 CRDi (100/135 kW)/ 2WD/ 4WD	
	5x114,3x67 ET 48				
€ 86,10				Modelljahr 2014 Ab EGBE: e11*2007/46*0192*06 Sonderrad mit ABE	
RDKS ASC; ASS; CUC; Huf 2.4; Huf 3.4; Huf 3.5; SE1C1; SE1C2; SE2C2; SE15					

ix35			EL, ELH, LM					
MAGNA	Celsio		CS 656 40 5 14	lichtsilber-lackiert				
	Tezzo		TZ 656 40 5 14	lichtsilber-lackiert / mattschwarz-lackiert				
	6½ J x16 H2	215/70R16		ABE				
	5 x 114,3 ET 40							
RDKS Celsio: ASC; ASS; CUC; Huf 2.4; Huf 3.4; Huf 3.5; SE1C1; SE1C2; SE15; TTC; TTS Tezzo: ASC; ASS; CUC; Huf 2.4; Huf 3.4; Huf 3.5; SE1C1; SE1C2; SE15; TTC						MK 047	CS	TZ



Santa-Fe (2WD)			01/01-02/06	SM	
Stahl	HY 515001	9520	154671	SUV	
	6 J x15 CH	215/70R15		2,0i (99 kW)/ 2,4i (107 kW)/ 2,0 CRDi (83 kW)	
	5x114,3x67 ET 46				
€ 103,00		Kegel sw 21 M12 x 1,5/H17		Nicht für 4x4. Einige FZG-Ausführungen nur 16 Zoll.	
RDKS					

Santa-Fe (2WD/4WD)			03/06-05/13	CM	
Stahl	HY 517001	8265	175471	SUV	
	7 J x17 H2	235/65R17		2,7 V6 (139 kW)/ 2,2 CRDi (110 kW)	
	5x114,3x67 ET 41				
€ 117,30		Kegel sw 21 M12 x 1,5/H17		Sonderrad mit ABE! Gutachten kann angefordert werden.	
RDKS					

		CM	Santa-Fe		
		lichtsilber-lackiert / mattschwarz-lackiert		Tezzo	TZ 757 40 5 14
			ABE	235/65R17 ✱	7½ J x17 H2 5 x 114,3 ET 40
	ABE	245/60R17			
TZ	TZ	MK 047	ASC; ASS; CUC; Huf 2.4; Huf 3.4; Huf 3.5; SE1C1; SE1C2; SE1S		



KRONPRINZ
MAGMA

RDKS

		DM	Santa-Fe		
		lichtsilber-lackiert / mattschwarz-lackiert		Interio	IN 807 45 5 14
			ABE	235/65R17 ✱	8 J x17 EH2+ 5 x 114,3 ET 45
	ABE	245/60R17 ✱			
	ABE	255/60R17			
IN	IN	MK 047	ASC; CUC; Huf 3.5; SE1C1; SE1S		

KRONPRINZ
MAGMA

RDKS

		JM, JMG	Tucson		
		lichtsilber-lackiert / mattschwarz-lackiert		Tezzo	TZ 656 40 5 14
			ABE	205/65R16 M+S ✱	6½ J x16 H2 5 x 114,3 ET 40
	ABE	205/70R16 M+S ✱			
TZ	TZ	MK 047	ASC; ASS; CUC; Huf 2.4; Huf 3.4; Huf 3.5; SE1C1; SE1C2; SE1S; TTC		

KRONPRINZ
MAGMA

RDKS

TL, TLE		09/15-	Tucson	
	SUV	163469	8756	HY 516009
	1,6i (97/130 kW)/ 1,7 CRDi (85 kW)/ 2,0 CRDi (100/136 kW)	215/70R16		6½ J x16 H2 5x114,3x67 ET 45 € 86,10
Nur in Verbindung mit 16 Zoll Bremsanlage! Nicht in Verbindung mit elektronischer Parkbremse!		ASC; ASS; CUC; Huf 2.4; Huf 3.4; Huf 3.5; SE1C1; SE1S		

Stahl

RDKS

TL, TLE		Tucson		
Radabbildung in Vorbereitung				in Vorbereitung

KRONPRINZ
MAGMA

RDKS

Daily S2000		07/99-	S2, S3
Stahl	IV 616011	163387	Transporter
	5 JK x16 H 6x170x130 ET 109	195/75R16	35C.../35-.../40C.../40-.../45C.../45-.../50C.../ 50-...; 63-122 kW
	€ 99,40		Für Zwillingbereifung. Auch Vorderachse. FZG-Schein und Unterlagen beachten. Je nach Fahrzeugausführung unterschiedliche Rad-/Reifenkombinationen zulässig.
RDKS	Huf 3.5; SE1S; SE2S		



Daily S2000		07/99-	S2
Stahl	IV 616012	163386	Transporter
	5½ J x16 H2 6x170x130 ET 107	185/75R16 195/65R16	35C.../35-.../40C.../40-...; 63-122 kW
	€ 99,40		Für Zwillingbereifung. Auch Vorderachse. FZG-Schein und Unterlagen beachten. Je nach Fahrzeugausführung unterschiedliche Rad-/Reifenkombinationen zulässig.
RDKS	ASC; ASS; CUC; Huf 2.4; Huf 3.4; Huf 3.5; SE1C1; SE1C2; SE2C1; SE2C2; SE1S; SE2S; TTC; TTS		



Daily S2000		07/99-	S4
Stahl	IV 616014	165501	Transporter
	6 J x16 H2 6x205x161 ET 124	225/75R16	65C...; (100-122 kW)
	€ 105,10		Für Zwillingbereifung. Auch Vorderachse. FZG-Schein und Unterlagen beachten. Je nach Fahrzeugausführung unterschiedliche Rad-/Reifenkombinationen zulässig.
RDKS	ASS; Huf 3.5; SE1S; SE2S		



Daily S2000		03/07-	C25C, C25V
Stahl	IV 616013	163389	Transporter
	6½ J x16 H2 6x125x74,1 ET 68	205/65R16 215/65R16	29L...; (71-100 kW)
	€ 105,10		Für Singlebereifung. FZG-Schein und Unterlagen beachten. Je nach Fahrzeugausführung unterschiedliche Rad-/Reifenkombinationen zulässig.
RDKS	ASS; Huf 3.5; SE2C2		



Daily S2000		03/07-	C30C, C30V
Stahl	IV 616013	163389	Transporter
	6½ J x16 H2 6x125x74,1 ET 68	225/65R16 235/65R16	35S...; (71-130 kW)
	€ 105,10		Für Singlebereifung. FZG-Schein und Unterlagen beachten. Je nach Fahrzeugausführung unterschiedliche Rad-/Reifenkombinationen zulässig.
RDKS	ASS; Huf 3.5; SE2C2		



		ML1	01/02-	Eurocargo			
	Transporter		165501			IV 616014	
	ML65E.../ ML75E...; (95-134 kW)		225/75R16			6 J x16 H2 6x205x161 ET 124 € 105,10	
		ASS; Huf 3.5; SE1S; SE2S					Stahl
							RDKS

JAGUAR

					XE	
Radabbildung in Vorbereitung					in Vorbereitung	MAGMA
					RDKS	

		CC9, N3	XF, XJ, XJR			
		lichtsilber-lackiert / mattschwarz-lackiert	Tezzo	TZ 757 45 5 08		MAGMA
		XJ / XJR Typ N3 nur Bereifung 235/55R17 / ABE ohne Schneekette	ABE	235/55R17 ❄	7½ J x17 H2 5 x 108 ET 45	
			ABE	245/50R17 ❄		
			ABE	255/50R17		
TZ	TZ	MK 042	ASC; ASS; CUC; Huf 2.4; Huf 3.4; Huf 3.5; SE1C1; SE1C2; SE1S			RDKS



Carens			08/02-08/06	FC	
Stahl	*KI 515003	8045	154697	Van	
	6 JJ x15 H2	195/60R15		1,8 LX (93 kW)/ 2,0 CDRI LX (83 kW)	
	4x114,3x67	205/60R15			
	ET 45				
	€ 91,80	Kegel sw 21 M12 x 1,5/H17		15 Zoll nur ab EGBE e11*98/14*0121*07 zulässig!	
RDKS					

Carens			09/06-02/13	FG	
Stahl	KI 515007	7660	154696	Van	
	6 J x15 H2	205/65R15		2,0 CRDi (103 kW)/ 2,0 CVVT (106 kW)	
	5x114,3x67				
	ET 41				
	€ 89,80	Kegel sw 21 M12 x 1,5/H17			
RDKS					

Carens			03/13-	RP	
Stahl	KI 516006	7765	163341	Van	
	6½ J x16 H2	205/55R16		1,6 GDI (99 kW)/ 2,0 GDI (122/130 kW)/ 1,7 CRDi (85/100 kW)	
	5x114,3x67				
	ET 48,5				
	€ 86,10	Kegel sw 21 M12 x 1,5			
RDKS ASC ; ASS ; CUC ; CUS ; Huf 2.4 ; Huf 3.4 ; Huf 3.5 ; SE1C1 ; SE1C2 ; SE2C2 ; SE1S ; SE2S ; TTC / OE: VDO 5180052092Z					

Carnival			06/06-	MB	
Stahl	KI 516002	7925	163470	Van	
	6½ J x16 H2	225/70R16		2,7 V6 (139 kW)/ 2,9 CRDi (136 kW)	
	6x139,7x92,5				
	ET 46				
	€ 102,50	Kegel sw 21 M12 x 1,5/H17			
RDKS					

Cee´d / Cee´d Sporty Wagon / Pro Cee´d			02/07-05/12	ED	
Stahl	KI 515006	8077	154695	Schrägheck, Kombi	
	5½ J x15 CH	185/65R15		1.4 CVVT/ 1.6 CVVT/ 2.0 CVVT/	
	5x114,3x67	195/65R15		1.6 CRDi 90/ 1.6 CRDi 115	
	ET 47	195/65R15		2,0 CRDi	
	€ 72,40	Kegel sw 21 M12 x 1,5/H17		Sporty Wagon -08/12 Pro Cee´d -05/13	
RDKS					

		ED, EDG, EDI	Cee'd / Cee'd Sporty Wagon / Pro Cee'd			
		lichtsilber-lackiert / mattschwarz-lackiert	Seismo	SO 605 45 5 14		
		lichtsilber-lackiert / mattschwarz-lackiert	Interio	IN 605 45 5 14		
			ABE	185/65R15 ☼	6 J x15 H2	
			ABE	195/65R15 ☼	5 x 114,3	
		ABE	205/60R15 ☼	ET 45		
SO	IN	MK 047	Seismo: ASC; ASS; Huf 2.4; Huf 3.4; SE1C1; SE1C2; SE1S; TTC Interio: ASC; ASS; CUS; Huf 2.4; Huf 3.4; SE1C1; SE1C2; SE1S; TTC; TTS			



MAGNA

RDKS

		ED	02/07-05/12	Cee'd / Cee'd Sporty Wagon / Pro Cee'd	
	Schrägheck, Kombi	163471	7790	KI 516003	
	1.4 CVT/ 1.6 CVT/ 2.0 CVT/ 1.6 CRDi 90/ 1.6 CRDi 115/ 2,0 CRDi	205/55R16		6 J x16 CH	
				5x114,3x67	
				ET 51	
	Sporty Wagon -08/12 Pro Cee'd -05/13	Kegel sw 21 M12 x 1,5/H17		€ 83,50	

Stahl

RDKS

		ED, EDG, EDI	Cee'd / Cee'd Sporty Wagon / Pro Cee'd			
		lichtsilber-lackiert	Celsio	CS 656 40 5 14		
		lichtsilber-lackiert / mattschwarz-lackiert	Tezzo	TZ 656 40 5 14		
			ABE	195/60R16 ☼	6½ J x16 H2	
			ABE	205/55R16 ☼	5 x 114,3	
				ET 40		
CS	TZ	MK 047	Celsio: ASC; ASS; CUC; Huf 2.4; Huf 3.4; Huf 3.5; SE1C1; SE1C2; SE1S; TTC; TTS Tezzo: ASC; ASS; CUC; Huf 2.4; Huf 3.4; Huf 3.5; SE1C1; SE1C2; SE1S; TTC			



MAGNA

RDKS

		JD	06/12-	Cee'd / Cee'd Sporty Wagon / Pro Cee'd	
	Schrägheck, Kombi	154524	8147	HY 515018	
	1,4 CVT (73 kW) / 1,6 GDI (99 kW) / 1,4 CRDi (66 kW) / 1,6 CRDi (94 kW)	195/65R15		6 J x15 CH	
				5x114,3x67	
				ET 46	
	Nicht in Verbindung mit elektronischer Parkbremse / Performance-Paket. Einige Ausführungen nur 16 Zoll. Sporty Wagon 09/12-; Pro Cee'd: 06/13-	Kegel sw 21 M12 x 1,5/H17		€ 72,90	
		ASC; ASS; CUC; CUS; Huf 2.4; Huf 3.4; Huf 3.5; SE1S; SE2S; TTC; TTS / OE: VDO S180052092Z			

Stahl

RDKS

		JD	Cee'd, Cee'd Sporty Wagon, Pro Cee'd			
		lichtsilber-lackiert / mattschwarz-lackiert	Tezzo	TZ 655 45 5 14		
		Achtung / Bremsanlage beachten	ABE	195/65R15	6½ J x15 H2	
			ABE	205/60R15	5 x 114,3	
					ET 45	
TZ	TZ	MK 047	ASC; ASS; CUC; Huf 2.4; Huf 3.4; Huf 3.5; SE1C1; SE1C2; SE1S; TTC / OE: VDO S180052092Z			

MAGNA

RDKS

Cee´d / Cee´d Sporty Wagon / Pro Cee´d		06/12-	JD	
Stahl	HY 516011	9147	163318	Schrägheck, Kombi
	6½ J x16 CH	205/55R16		1,4 CVVT (73 kW) / 1,6 GDI (99 kW) / 1,4 CRDi (66 kW) / 1,6 CRDi (94 kW)
	5x114,3x67			
	ET 51			
	€ 84,00	Kegel sw 21 M12 x 1,5/H17		Sporty Wagon 09/12- Pro Cee´d 06/13-
RDKS	ASC; ASS; CUC; CUS; Huf 2.4; Huf 3.4; Huf 3.5; SE1C1; SE1C2; SE2C2; SE1S; SE2S / OE: VDO S180052092Z			



Cee´d, Cee´d Sporty Wagon, Pro Cee´d			JD	
MAGMA	Celsio	CS 656 50 5 14	lichtsilber-lackiert	
	6½ J x16 H2	195/55R16 *	ABE	Achtung / Bremsanlage beachten
	5 x 114,3	205/55R16	ABE	
	ET 50	215/50R16	ABE	
RDKS	ASC; ASS; CUC; Huf 2.4; Huf 3.4; Huf 3.5; SE1C1; SE1C2; SE1S; TTC; TTS			MK 047



CS

Optima			TF			
MAGMA	Tezzo	TZ 656 40 5 14	lichtsilber-lackiert / mattschwarz-lackiert			
	6½ J x16 H2	205/60R16 *	ABE	Achtung / Bremsanlage beachten		
	5 x 114,3	205/65R16	ABE			
	ET 40	215/60R16	ABE			
RDKS	ASC; ASS; CUC; Huf 2.4; Huf 3.4; Huf 3.5; SE1C1; SE1C2; SE1S; TTC / OE: VDO S180052092Z			MK 047	TZ	TZ

Optima II (Neues Modell)				
MAGMA	in Vorbereitung			Radabbildung in Vorbereitung
RDKS				

Picanto		04/04-12/07	BA	
Stahl	KI 513003	2490	133579	Schrägheck
	4.00 B x13 H2	155/70R13		1,0i (45 kW) / 1,1i (48 kW)
	4x100x54			
	ET 46			
	€ 62,90	Kegel sw 21 M12 x 1,5/H17		
RDKS				

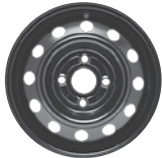

		BA	04/04-12/07	Picanto	
	Schrägheck	143778	5490	KI 514004	Stahl
	1,0i (45 kW)/ 1,1i (48 kW)/	165/60R14		5 J x14 H2	
	1,1 CRDi (55 kW)	175/60R14		4x100x54 ET 46	
		Kegel sw 21 M12 x 1,5/H17		€ 71,90	
RDKS					

		BA	01/08-02/11	Picanto	
	Schrägheck	133579	2490	KI 513003	Stahl
	1,1i (48 kW)	155/70R13		4.00 B x13 H2	
				4x100x54 ET 46	
		Kegel sw 21 M12 x 1,5/H17		€ 62,90	
RDKS					

		BA	01/08-02/11	Picanto	
	Schrägheck	143778	5490	KI 514004	Stahl
	1,1i (48 kW)/ 1,1 CRDi (55 kW)	175/60R14		5 J x14 H2	
				4x100x54 ET 46	
		Kegel sw 21 M12 x 1,5/H17		€ 71,90	
RDKS					



		TA	03/11-	Picanto II	
	Schrägheck	133579	2490	KI 513003	Stahl
	1,0i (51 kW)/ 1,3i (63 kW)/ 1,0 LPG (60 kW)	155/70R13		4.00 B x13 H2	
				4x100x54 ET 46	
		Kegel sw 21 M12 x 1,5/H17		€ 62,90	
RDKS					

		TA	03/11-	Picanto II	
	Schrägheck	143781	5965	KI 514006	Stahl
	1,0i (51 kW)/ 1,3i (63 kW)/ 1,0 LPG (60 kW)	165/60R14		5 J x14 H2	
				4x100x54 ET 49	
		Kegel sw 21 M12 x 1,5/H17		€ 71,90	
RDKS					

ASC ; ASS ; CUC ; CUS ; Huf 2.4 ; Huf 3.4 ; Huf 3.5 ; SE2S ; TTC / OE: VDO S180052092Z

Rio		08/05-08/11	DE	
Stahl	KI 514005	7230	143777	Steilheck
	5½ J x14 H2	185/65R14		1,4i (71 kW) / 1,6i (82 kW) / 1,5 CRDi (81 kW)
	4x100x54			
	ET 46			
RDKS	€ 72,90	Kegel sw 21 M12 x 1,5/H17		

Rio		09/11-	UB	
Stahl	KI 515010	7530	154578	Schrägheck
	5½ J x15 H2	185/65R15		1,2i (63 kW) / 1,4i (80 kW) / 1,1D (55 kW) / 1,4D (66 kW)
	4x100x54			
	ET 36			
RDKS	€ 75,50	Kegel sw 21 M12 x 1,5/H17		
RDKS	ASC; ASS; CUC; CUS; Huf 2.4; Huf 3.4; Huf 3.5; SE1C1; SE1C2; SE1C2; SE1S; SE2S; TTC / OE: TRW 52933-3X300			

Rio		UB				
MAGNA	Celsio	CS 655 35 4 00	lichtsilber-lackiert			
	Tezzo	TZ 655 35 4 00	lichtsilber-lackiert / mattschwarz-lackiert			
	6½ J x15 H2	185/65R15	ABE			
	4 x 100					
RDKS	ET 35			CS	TZ	
RDKS	Celsio: ASC; ASS; CUC; Huf 2.4; Huf 3.4; Huf 3.5; SE1C1; SE1C2; SE1S; TTC; TTS Tezzo: ASC; ASS; CUC; Huf 2.4; Huf 3.4; Huf 3.5; SE1C1; SE1C2; SE1S; TTC				MK 030	



Sorento II		XM, XMG, XM FL				
MAGNA	Tezzo	TZ 757 40 5 14	lichtsilber-lackiert / mattschwarz-lackiert			
	7½ J x17 H2	235/65R17	ABE	Typ XM FL nur Bereifung 235/65R17 / Tüev Auflagen beachten		
	5 x 114,3	245/60R17	ABE			
	ET 40					
RDKS	ASC; ASS; CUC; Huf 2.4; Huf 3.4; Huf 3.5; SE1C1; SE1C2; SE1S / OE: VDO S180052092Z				MK 047	



Sorento II		XM, XMG, XM FL				
MAGNA	Celsio	CS 808 38 5 14	lichtsilber-lackiert			
	8 J x18 EH2+	235/55R18 *	ABE	Typ XM FL nur Bereifung 245/55R18 / Tüev Auflagen beachten		
	5 x 114,3	235/60R18	ABE			
	ET 38	245/55R18	TÜV			
RDKS	ASC; ASS; CUC; Huf 2.4; Huf 3.4; Huf 3.5; SE1C1; SE1C2; SE1S; TTC / OE: VDO S180052092Z				MK 047	CS

		UM	Sorento III	
Radabbildung in Vorbereitung				in Vorbereitung
RDKS				

		AM	02/09-02/14	Soul	
	Steilheck	154577	7610	KI 515008	Stahl
	1,6 CVVT (93 kW)/ 1,6 CRDI (94 kW)	195/65R15		6 J x15 H2	
	Einige Ausführungen nur LM-Räder!	Kegel sw 21 M12 x 1,5/H17		5x114,3x67 ET 44	
				€ 75,50	RDKS

		PS, PSEV	03/14-	Soul II	
	Steilheck	163426	8787	KI 516007	Stahl
	1,6 GDI (97 kW)/ 2,0 CVVT (113 kW)/ 1,6 CRDI (94 kW)/ Elektro	205/60R16		6½ J x16 H2	
				5x114,3x67 ET 47	
				€ 86,10	RDKS
<small>ASC; ASS; CUC; CUS; Huf 2.4; Huf 3.5; SE1C1; SE1C2; SE2C2; SE1S; SE2S; TTS / OE: Schrader 3059</small>					

		PS	Soul II			
		lichtsilber-lackiert / mattschwarz-lackiert	Tezzo	TZ 656 40 5 14		Stahl
			ABE	205/60R16	6½ J x16 H2	
					5 x 114,3 ET 40	
MK 047		<small>ASC; ASS; CUC; Huf 2.4; Huf 3.4; Huf 3.5; SE1C1; SE1C2; SE1S; TTC / OE: Schrader 3059</small>				RDKS

		JE, JES, JESG	Sportage			
		lichtsilber-lackiert	Celsio	CS 656 40 5 14		Stahl
		lichtsilber-lackiert / mattschwarz-lackiert	Tezzo	TZ 656 40 5 14		
			ABE	215/65R16 ❄️	6½ J x16 H2	
			ABE	225/60R16	5 x 114,3	
			ABE	235/60R16	ET 40	
MK 047		<small>Celsio: ASC; ASS; CUC; Huf 2.4; Huf 3.4; Huf 3.5; SE1C1; SE1C2; SE1S; TTC; TTS Tezzo: ASC; ASS; CUC; Huf 2.4; Huf 3.4; Huf 3.5; SE1C1; SE1C2; SE1S; TTC</small>				RDKS

Sportage		09/10-02/14	SL, SLS	
Stahl	KI 516004	8987	163473	SUV
	6½ J x16 H2	215/65R16		1,6 GDI (99 kW)/ 2,0 CVVT (120 kW)/ 1,7 CRDi (85 kW)/ 2,0 CRDi (100/135 kW)/ 2WD
	5x114,3x67	215/70R16		
	ET 31,5	225/65R16		2,0 CVVT (120 kW)/ 2,0 CRDi (100/135 kW)/ 4WD
RDKS	€ 86,10	Kegel sw 21 M12 x 1,5/H17		Sonderrad mit ABE! Auflagen im Gutachten beachten! 225/65R16 nur 4WD!



Sportage (Facelift)		03/14-05/16	SL, SLS	
Stahl	KI 516008	8837	163427	SUV
	6½ J x16 CH	215/70R16		1,6i (99 kW)/ 2,0i (122 kW)/ 1,7 CRDi (85 kW)/ 2,0 CRDi (100/135 kW)
	5x114,3x67			
	ET 36			
RDKS	€ 86,10			
RDKS	ASC; ASS; CUC; Huf 2.4; Huf 3.4; Huf 3.5; SE1C1; SE1C2; SE2C2; SE1S; SE2S			





Sportage		SL, SLS			
MAGNA	Celsio	CS 656 40 5 14	lichtsilber-lackiert		
	Tezzo	TZ 656 40 5 14	lichtsilber-lackiert / mattschwarz-lackiert		
	6½ J x16 H2	215/70R16	ABE	Typ SL/SLS: Räder auch frei für Modelle ab Baujahr 2014.	
	5 x 114,3	225/65R16	ABE		
ET 40					
RDKS	Celsio: ASC; ASS; CUC; Huf 2.4; Huf 3.4; Huf 3.5; SE1C1; SE1C2; SE1S; TTC; TTS Tezzo: ASC; ASS; CUC; Huf 2.4; Huf 3.4; Huf 3.5; SE1C1; SE1C2; SE1S; TTC		MK 047	CS	TZ



Sportage		06/16-	QL
Stahl	INFO		SUV
			INFO
RDKS			Radabbildung in Vorbereitung

Sportage (2016)		QL
MAGNA		
	in Vorbereitung	
RDKS		Radabbildung in Vorbereitung

YN, YNS		03/10-	Venga		
	Mini-Van	154676	6505	KI 515009	
	1,4 CVVT (66 kW) / 1,6 CVVT (93 kW) / 1,4 CRDi (55/66 kW) / 1,6 CRDi (94 kW)	195/65R15		6 J x15 H2 5x114,3x67 ET 48	
		Kegel sw 21 M12 x 1,5/H17		€ 72,90	
		ASC; ASS; CUC; CUS; Huf 2.4; Huf 3.4; Huf 3.5; SE1C1; SE1C2; SE2C2; SE1S; SE2S; TTC / OE: VDO S180052092Z			RDKS

YN, YNS		Venga		
		lichtsilber-lackiert / mattschwarz-lackiert		Interio
				IN 605 45 5 14
IN		ABE	195/60R15 ✱	6 J x15 H2
		ABE	195/65R15 ✱	5 x 114,3
		ABE	205/60R15 ✱	ET 45
	MK 047	ASC; ASS; CUS; Huf 2.4; Huf 3.4; SE1C1; SE1C2; SE1S; TTC; TTS		

		Granta (2015)	
Radabbildung in Vorbereitung			in Vorbereitung

111 / 217		Kalina / Priora		
		lichtsilber-lackiert / mattschwarz-lackiert		Seismo
				SO 604 35 4 98
SO		ABE	175/65R14	6 J x14 H2
		ABE	185/60R14	4 x 98
				ET 35
	MK 106	ASC; ASS; Huf 2.4; Huf 3.4; SE1C1; SE1C2; SE1S; TTC; TTS		

Vesta (2015)			
MAGNA	in Vorbereitung		
RDKS			

Radabbildung
in
Vorbereitung



LANCIA

Delta		04/08-12/14	844
Stahl	FL 516004	9087	163385
	7 J x16 H2	195/55R16	Schrägheck
	4x98x58	205/55R16	1,4 T-Jet 16V (88/110 kW)/ 1,6 Multijet 16 V (88 kW)/ 1,9 Multijet TwinTurbo (140 kW)/ 2,0 Multijet 16 V (121 kW)
	ET 31		
	€ 87,70	Kegel sw 17 M12 x 1,25 x 22	
RDKS		ASC; ASS; CUC; Huf 2.4; SE1C1; SE2C2; SE1S / OE: TRW 51839114	
Musa		10/04-	350 (LANCIA)
Stahl	FL 515009	8185	154589
	6 J x15 H2	195/60R15	Mini-Van
	4x98x58		1,4 16V (57/66/70kW)/ 1,3 16V Multijet (51 kW)/ 1,9 Multijet (74 kW)
	ET 40		
	€ 74,00	Kegel sw 17 M12 x 1,25 x 22	
RDKS		ASC; ASS; CUC; Huf 2.4; Huf 3.4; SE1C1; SE1S; TTC; TTS / OE: Schrader 3017	
Ypsilon		09/03-05/11	843, 843 (Lancia)
Stahl	FL 515009	8185	154589
	6 J x15 H2	195/55R15	Schrägheck
	4x98x58		1,2 (44 kW)/ 1,2 16V (59 kW)/ 1,4 16V (57/70 kW) 1,3 Multijet 16V (51/55/66/77 kW)
	ET 40		
	€ 74,00	Kegel sw 19 M12 x 1,25 x 22	
RDKS			













		312	06/11-	Ypsilon	
	Schrägheck	154596	8753	FL 515021	
	0,9i (63 kW) / 1,2i (51 kW) / 1,2D (70 kW)	185/55R15		6 J x15 H2	
		195/50R15		4x98x58	
				ET 30	
			Kegel sw 17 M12 x 1,25 x 22	€ 77,30	
					Stahl
					RDKS

LAND ROVER

		LV, LV-A	Range Rover Evoque		
		lichtsilber-lackiert / mattschwarz-lackiert	Tezzo	TZ 757 45 5 08	
					7½ J x17 H2
TZ	TZ	MK 070	ABE	225/65R17 ❄	5 x 108
			ABE	235/65R17 ❄	ET 45
			ABE	245/60R17 ❄	
			ASC ; ASS ; CUC ; Huf 2.4 ; Huf 3.4 ; Huf 3.5 ; SE1C1 ; SE1C2 ; SE1S / OE-VDO S180052028Z		
					MAGMA
					RDKS

		LF	03/07-	Freelander II	
	SUV	163414	8465	FO 516007	
	2,2TD4 (112 kW)	215/75R16		6½ J x16 H2	
				5x108x63,3	
				ET 50	
			Kegel sw 21 M14 x 1,5/H15	€ 80,30	
			ASC ; ASS ; CUC ; Huf 2.4 ; Huf 3.4 ; Huf 3.5 ; SE1C1 ; SE1C2 ; SE2C1 ; SE2C2 ; SE1S ; SE2S ; TTC ; TTS / OE-VDO S180052028Z		
					Renner
					RDKS

		LF	Freelander II		
		lichtsilber-lackiert / mattschwarz-lackiert	Tezzo	TZ 656 45 5 08	
					6½ J x16 H2
TZ	TZ	MK 070	ABE	215/75R16	5 x 108
			ABE	225/70R16	ET 45
			ABE	225/75R16	
			ASC ; ASS ; CUC ; Huf 2.4 ; Huf 3.4 ; Huf 3.5 ; SE1C1 ; SE1C2 ; SE1S ; TTC / OE-VDO S180052028Z		
					MAGMA
					RDKS

CT 200h				A10(a)			
KRONPRINZ MAGNA	Interio		IN 706 38 5 00		lichtsilber-lackiert / mattschwarz-lackiert		
	7 J x16 EH2+	205/55R16	☼	ABE			
	5 x 100	215/50R16	☼	ABE			
ET 38							
RDKS	ASC; CUC; Huf 2.4; Huf 3.4; Huf 3.5; SE1C1; SE1S				MK 032	IN	IN
SC430 / IS-F				S19 (a), HS19 (a), UXE2(a), Z4			
KRONPRINZ MAGNA	Celsio		CS 808 38 5 14		lichtsilber-lackiert		
	8 J x18 EH2+	225/40R18	ABE	Bereifung 225/40R18 nur für IS-F.			
	5 x 114,3	245/40R18	ABE				
ET 38							
RDKS	ASC; ASS; CUC; Huf 2.4; Huf 3.4; Huf 3.5; SE1C1; SE1C2; SE1S; TTC				MK 040	CS	
GS				HL10(a), L10(a)			
KRONPRINZ MAGNA	Tezzo		TZ 757 40 5 14		lichtsilber-lackiert / mattschwarz-lackiert		
	7½ J x17 H2	225/50R17	☼	ABE			
	5 x 114,3	235/45R17	☼	ABE			
ET 40	245/45R17	☼	ABE				
RDKS	ASC; ASS; CUC; Huf 2.4; Huf 3.4; Huf 3.5; SE1C1; SE1C2; SE1S				MK 040	TZ	TZ
IS 200D / IS220D / IS250				XE2 (a)			
KRONPRINZ MAGNA	Interio		IN 706 45 5 14		lichtsilber-lackiert / mattschwarz-lackiert		
	7 J x16 EH2+	205/55R16	ABE	Rad nur für Modelle bis Nachtrag 09			
	5 x 114,3	215/55R16	ABE				
ET 45	225/50R16	ABE					
RDKS	ASC; CUC; Huf 2.4; Huf 3.4; Huf 3.5; SE1C1; SE1S				MK 040	IN	IN
RX 350, RX450h				AL1 (a), HAL1 (a)			
KRONPRINZ MAGNA	Celsio		CS 808 38 5 14		lichtsilber-lackiert		
	8 J x18 EH2+	235/55R18	☼	ABE			
	5 x 114,3	235/60R18	☼	ABE			
ET 38	245/55R18	ABE					
RDKS	ASC; ASS; CUC; Huf 2.4; Huf 3.4; Huf 3.5; SE1C1; SE1C2; SE1S; TTC				MK 040	CS	

		DY	04/03-09/07	2	
	Steilheck	143304	6275	FO 514010	Stahl
	MZI 1,25 (55 kW)/ MZI 1,4 (59 kW)/ MZI 1,6 (74 kW) MZ-CD 1,4 (50 kW)	175/65R14		5½ J x14 H2 4x108x63,3 ET 47,5	
			Kegel sw 19 M12 x 1,5/H15	€ 57,10	
RDKS					
		DE, DEE, DE1	10/07-01/15	2	
	Steilheck	143726	5270	MA 514009	Stahl
	1,3 MZR (55/63 kW)/ 1,5 MZR (76 kW)/ 1,4 MZ-CD (50 kW)	175/65R14		6 J x14 H2 4x100x54 ET 45	
			Kegel sw 21 M12 x 1,5/H17	€ 68,70	
ASC ; ASS ; CUC ; SE1C1 ; SE1C2 ; SE1S RDKS					
		DE, DE1	10/07-01/15	2	
	Steilheck	154627	7190	MA 515011	Stahl
	1,3 MZR (55/63 kW)/ 1,5 MZR (76 kW)/ 1,4 MZ-CD (50 kW)	185/55R15		6 J x15 H2 4x100x54 ET 45	
			Kegel sw 21 M12 x 1,5/H17	€ 75,50	
ASC ; ASS ; CUC ; CUS ; Huf 2.4 ; Huf 3.4 ; Huf 3.5 ; SE1C1 ; SE1C2 ; SE2C2 ; SE1S ; SE2S ; TTC ; TTS RDKS					
		DJ1	02/15-	2	
	Steilheck	154637	7225	MA 515014	Stahl
	1,5i (55/66 kW)	185/60R15		5½ J x15 H2 4x100x54 ET 40	
Nicht 85 kW.				€ 72,40	
RDKS					
		BK	09/03-03/09	3	
	Schräg-/Stufenheck	163422	9980	MA 516001	Stahl
	1,6 MZR (77 kW)/ 2,0 MZR (110 kW) 1,6 MZ-CD (80 kW)	205/55R16		6½ J x16 H2 5x114,3x67 ET 52,5	
			Kegel sw 21 M12 x 1,5/H17	€ 83,50	
RDKS					

3			BK		
MAGNA	Celsio		CS 656 50 5 14		lichtsilber-lackiert
	6½ J x16 H2	205/55R16	☼	ABE	
	5 x 114,3				
ET 50					
RDKS	ASC; ASS; CUC; Huf 2.4; Huf 3.4; Huf 3.5; SE1C1; SE1C2; SE1S; TTC; TTS				MK 047

CS

3			04/09-09/13	BL	
Stahl	MA 515012	7223	154628	4-/5-Türer	
	6 J x15 H2	195/65R15		1,6 MZR (77 kW)/ 1,6 MZ-CD (80 kW)	
	5x114,3x67				
	ET 50				
	€ 72,40	Kegel sw 21 M12 x 1,5/H17		Bis EGBE e11*2001/116*0262*09	
RDKS					

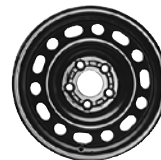

3			BL, BLE		
MAGNA	Celsio		CS 656 50 5 14		lichtsilber-lackiert
	6½ J x16 H2	195/55R16	ABE		
	5 x 114,3	205/50R16	ABE		
ET 50	205/55R16	ABE			
RDKS	ASC; ASS; CUC; Huf 2.4; Huf 3.4; Huf 3.5; SE1C1; SE1C2; SE1S; TTC; TTS				MK 047

CS

3			10/13-	BL	
Stahl	MA 516007	9062	163342	4-/5-Türer	
	6½ J x16 H2	205/60R16		2.0 MZR (88 kW)/ 2.2 MZR-CD (110 kW)	
	5x114,3x67				
	ET 50				
	€ 82,40	Kegel sw 21 M12 x 1,5		Ab EGBE e11*2001/116*0262*10	
RDKS	ASC; ASS; CUC; CUS; Huf 2.4; Huf 3.4; Huf 3.5; SE1C1; SE1C2; SE2C2; SE2S; TTC				



3 (Neues Modell)			BL			
MAGNA	Tezzo		TZ 656 40 5 14		lichtsilber-lackiert / mattschwarz-lackiert	
	6½ J x16 H2	205/60R16	ABE			
	5 x 114,3	215/55R16	ABE			
ET 40						
RDKS	ASC; ASS; CUC; Huf 2.4; Huf 3.4; Huf 3.5; SE1C1; SE1C2; SE1S; TTC				MK 047	

TZ

TZ

		BL	3 (Neues Modell)		
	IN	lichtsilber-lackiert / mattschwarz-lackiert	Interio		IN 706 45 5 14
			ABE	205/60R16	
			ABE	215/55R16	
		MK 047	ASC; CUC; Huf 2.4; Huf 3.4; Huf 3.5; SE1C1; SE1S		
					RDKS

		CR1	5		
	CS	lichtsilber-lackiert	Celsio		CS 656 50 5 14
			ABE	205/55R16	
		MK 047	ASC; ASS; CUC; Huf 2.4; Huf 3.4; Huf 3.5; SE1C1; SE1C2; SE1S; TTC; TTS		
					RDKS

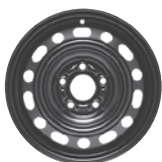
		CW	09/10-	5	
		Mini-Van	154625	7975	MA 515009
		1,8i (85 kW)/ 2,0i (106/110 kW)/ 1,6D (85 kW)	195/65R15		6 J x15 H2 5x114,3x67 ET 52,5
			205/60R15		
			Kegel sw 21 M12 x 1,5		€ 75,50
			ASS; CUS; Huf 3.5; SE1S; SE2S		
					RDKS



		CW	5		
	CS	lichtsilber-lackiert	Celsio		CS 656 50 5 14
			ABE	195/55R16	
			ABE	195/60R16	
			ABE	205/55R16	
		MK 047	ASC; ASS; CUC; Huf 2.4; Huf 3.4; Huf 3.5; SE1C1; SE1C2; SE1S; TTC; TTS		
					RDKS

		GG/GY, GG1	06/02-01/08	6	
		Fließheck, Stufenheck, Kombi	154622	8735	MA 515006
		1,8 MZR (88 kW)/ 2,0 MZR (104 kW)/ 2,0 MZR-CD (89/100 kW)	195/65R15		6 JJ x15 H2 5x114,3x67 ET 50
		1,8 MZR/ 2,0 MZR/ 2,0 MZR-CD/ 2,3 MZR (122 kW)	195/65R15 M+S		
			Kegel sw 21 M12 x 1,5/H17		€ 78,70
					RDKS

6			02/08-01/13	GH, GHE	
Stahl	MA 516004	9532	163421	Fließheck, Stufenheck, Kombi	
	6 J x16 H2	195/65R16		1,8 MZR (88kW)/ 2,0 MZR (108 kW)/	
	5x114,3x67	205/60R16		2,5 MZR (125 kW) / 2,0 MZR-CD (103 kW)/ 2,2 MZR-CD (120 kW)	
	ET 50				
	€ 84,00	Kegel sw 21 M12 x 1,5/H17		Typ GH: bis EGBE e1*2001/116*0448*13	
RDKS					

6			GH, GHE		
MAGNA	Celsio	CS 656 50 5 14	lichtsilber-lackiert		
	6½ J x16 H2	195/65R16 M+S	ABE		
	5 x 114,3	205/60R16	ABE		
	ET 50				
RDKS			ASC; ASS; CUC; Huf 2.4; Huf 3.4; Huf 3.5; SE1C1; SE1C2; SE1S; TTC; TTS	MK 047	CS



6			02/13-	GH, GJ	
Stahl	MA 516006	9127	163329	Stufenheck, Kombi	
	6½ J x16 H2	215/65R16		2,0i (107/121/141 kW)/ 2,2D (110/129 kW)	
	5x114,3x67				
	ET 42				
	€ 84,50	Kegel sw 21 M12 x 1,5		Typ GH: ab EGBE e1*2001/116*0448*14	
RDKS			ASC; ASS; CUC; CUS; Huf 2.4; Huf 3.4; Huf 3.5; SE1C1; SE1C2; SE2C2; SE1S; SE2S; TTC / OE: VDO 5180052054Z		



6 (Neues Modell)			GH, GEHE, GJ		
MAGNA	Interio	IN 706 45 5 14	lichtsilber-lackiert / mattschwarz-lackiert		
	7 J x16 EH2+	215/60R16 M+S	ABE		
	5 x 114,3	215/65R16 M+S	ABE		
	ET 45	225/60R16 M+S	ABE		
RDKS			ASC; CUC; Huf 2.4; Huf 3.4; Huf 3.5; SE1C1; SE1S	MK 047	IN

CX-3			06/15-	DJ1	
Stahl	MA 516007	9062	163342	SUV	
	6½ J x16 H2	215/60R16		2,0i (88/110 kW)	
	5x114,3x67				
	ET 50				
	€ 82,40				
RDKS			ASC; ASS; CUC; CUS; Huf 2.4; Huf 3.4; Huf 3.5; SE1C1; SE1C2; SE2C2; SE2S; TTC		



		DJ1	CX-3	
Radabbildung in Vorbereitung				in Vorbereitung
				RDKS

		KE	04/12-	CX-5	
	SUV		175302	9993	MA 517001
	2,0i (118/121 kW) / 2,0D (118 kW) / 2,2D (110/129 kW)		225/65R17		7 J x17 H2 5x114,3x67 ET 50
			Kegel sw 21 M12 x 1,5		€ 107,80
ASC; ASS; CUC; CUS; Huf 2.4; Huf 3.4; Huf 3.5; SE1C1; SE1C2; SE2C2; SE1S; SE2S; TTC; TTS					
				RDKS	



		KE, GH, GEH		CX-5	
		lichtsilber-lackiert / mattschwarz-lackiert		Tezzo	TZ 757 40 5 14
		Serienbereifung beachten	ABE	225/65R17 ❄	7½ J x17 H2
			ABE	235/60R17 ❄	5 x 114,3 ET 40
TZ	TZ	MK 047	ASC; ASS; CUC; Huf 2.4; Huf 3.4; Huf 3.5; SE1C1; SE1C2; SE1S		
				RDKS	

		KE, GH, GEH		CX-5	
		lichtsilber-lackiert / mattschwarz-lackiert		Interio	IN 807 45 5 14
		Serienbereifung beachten	ABE	225/65R17 ❄	8 J x17 EH2+
			ABE	235/60R17 ❄	5 x 114,3 ET 45
IN	IN	MK 047	ASC; CUC; Huf 3.5; SE1C1; SE1S		
				RDKS	

		NC1, NC1E	10/05-08/15	MX-5	
	Roadster		163420	9646	MA 516003
	1,8i (93 kW) / 2,0i (103 kW)		205/50R16		6½ J x16 H2 5x114,3x67 ET 55
	Einige Fahrzeugausführungen nur 205/50R16 M+S.		Kegel sw 21 M12 x 1,5/H17		€ 83,50
ASS; Huf 3.5; SE2S					
				RDKS	

MX-5			NC1, NC1E	
MAGMA	Celsio		CS 656 50 5 14	lichtsilber-lackiert
	6½ J x16 H2	205/50R16	TÜV	Auflagen beachten!
	5 x 114,3	205/50R16 M+S	TÜV	
	ET 50			
RDKS	ASC; ASS; CUC; Huf 2.4; Huf 3.4; Huf 3.5; SE1C1; SE1C2; SE1S; TTC; TTS			MK 047
				
CS				
MX-5 (Neues Modell)			ND	
MAGMA				
	in Vorbereitung			
RDKS				
				
Radabbildung in Vorbereitung				

MCC / SMART

Smart ForFour		04/04-07/06	454
Stahl	MC 514001	6670	143635
	5½ J x14 H2	175/65R14	
	4x114,3x67		
	ET 46		
€ 66,00	Kegel sw 21 M12 x 1,5/H17		
RDKS			
			
Smart ForFour		04/04-07/06	454
Stahl	MC 515005	7960	154632
	6 J x15 H2	195/50R15	
	4x114,3x67		
	ET 46		
€ 79,20	Kegel sw 21 M12 x 1,5/H17		
RDKS			
			

		451	11/14-	Smart ForFour II	
	Steilheck 1,0i (52 kW)	154608	4003	MC 515008	Stahl
	Nur für Vorderachse zulässig!	165/65R15		5 J x15 H2 4x100x60 ET 32 € 68,90	
		ASC; ASS; Huf 2.4; Huf 3.4; SE1C1; SE1C2; SE1S; TTC; TTS / OE: Schrader 3041			RDKS
		451	11/14-	Smart ForFour II	
	Steilheck 1,0i (52 kW)	154609	4004	MC 515009	Stahl
	Nur für Hinterachse zulässig!	185/60R15		5½ J x15 H2 4x100x60 ET 42 € 69,90	
		ASC; ASS; CUC; CUS; Huf 2.4; Huf 3.4; SE1C1; SE1C2; SE1S; TTC; TTS / OE: Schrader 3041			RDKS
		MC 01	10/98-01/04	Smart ForTwo	
	City-Coupé, Cabrio 0,6i (33/40 kW)/0,8 CDI (30 kW)	154510	7800	MC 515001	Stahl
	Nur für Vorderachse zulässig!	135/70R15		3½ J x15 H 3x112x57 ET 20,5 € 64,30	
		Kugel sw 17 M12 x 1,5 x 25			RDKS
		MC 01	10/98-01/04	Smart ForTwo	
	City-Coupé, Cabrio 0,6i (33/40 kW)/ 0,7i (37/45 kW)	154518	7850	MC 515003	Stahl
	Nur für Vorderachse zulässig!	145/65R15		4 J x15 H2 3x112x57 ET 27 € 62,90	
		Kugel sw 17 M12 x 1,5 x 25			RDKS
		MC 01	10/98-01/04	Smart ForTwo	
	City-Coupé, Cabrio 0,6i (33/40 kW)/ 0,7i (37/45 kW) 0,8 cdi (30 kW)	154511	7900	MC 515002	Stahl
	Nur für Hinterachse zulässig!	175/55R15		5½ J x15 H2 3x112x57 ET -1 € 63,90	
		Kugel sw 17 M12 x 1,5 x 25			RDKS



Smart ForTwo			02/04-03/07	MC 01	
Stahl	MC 515001	7800	154510	Coupé, Cabrio	
	3½ J x15 H	135/70R15		0,8 CDI (30 kW)	
	3x112x57 ET 20,5				
€ 64,30		Kugel sw 17 M12 x 1,5 x 25		Nur für Vorderachse zulässig! FZG-Schein beachten, Radgröße muss eingetragen sein!	
RDKS					

Smart ForTwo			02/04-03/07	MC 01	
Stahl	MC 515003	7850	154518	Coupé, Cabrio	
	4 J x15 H2	145/65R15		0,7i (37/45 kW)/ 0,8 CDI (30 kW)	
	3x112x57 ET 27				
€ 62,90		Kugel sw 17 M12 x 1,5 x 25		Nur für Vorderachse zulässig! FZG-Schein beachten, Radgröße muss eingetragen sein!	
RDKS					



Smart ForTwo			02/04-03/07	MC 01	
Stahl	MC 515002	7900	154511	Coupé, Cabrio	
	5½ J x15 H2	175/55R15		0,7i (37/45 kW)/ 0,8 CDI (30 kW)	
	3x112x57 ET -1				
€ 63,90		Kugel sw 17 M12 x 1,5 x 25		Nur für Hinterachse zulässig! FZG-Schein beachten, Radgröße muss eingetragen sein!	
RDKS					



Smart ForTwo			04/07-10/14	451, 451E	
Stahl	MC 515006	7820	154520	Coupé, Cabrio	
	4½ J x15 H2	155/60R15		1,0i (40/45/52/62/72/75 kW)/ 0,8 CDI (33 kW)/ 1,0 mhd (52 kW)	
	3x112x57 ET 23,5				
€ 62,90		Kugel sw 17 M12 x 1,5 x 25		Nur für Vorderachse zulässig!	
RDKS					

Smart ForTwo			04/07-10/14	451, 451E	
Stahl	MC 515007	7830	154521	Coupé, Cabrio	
	5½ J x15 H2	175/55R15		1,0i (40/45/52/62/72/75 kW)/ 0,8 CDI (33 kW)/ 1,0 mhd (52 kW)	
	3x112x57 ET 22				
€ 63,90		Kugel sw 17 M12 x 1,5 x 25		Nur für Hinterachse zulässig!	
RDKS					



		451	11/14-	Smart ForTwo II		
	Coupé, Cabrio	154608	4003	MC 515008		
	0,9T (66 kW)/ 1,0i (45/52 kW)	165/65R15		5 J x15 H2 4x100x60 ET 32		
	Nur für die Vorderachse zulässig!			€ 68,90		
		ASC; ASS; Huf 2.4; Huf 3.4; SE1C1; SE1C2; SE15; TTC; TTS / OE: Schrader 3041				RDKS
		451	11/14-	Smart ForTwo II		
	Coupé, Cabrio	154609	4004	MC 515009		
	0,9T (66 kW)/ 1,0i (45/52 kW)	185/60R15		5½ J x15 H2 4x100x60 ET 42		
	Nur für die Hinterachse zulässig!			€ 69,90		
		ASC; ASS; CUC; CUS; Huf 2.4; Huf 3.4; SE1C1; SE1C2; SE15; TTC; TTS / OE: Schrader 3041				RDKS

MERCEDES-BENZ

		168	10/97-08/04	A-Klasse / A-Klasse-L		
	Steilheck	153501	8220	ME 515036		
	A140/A140-L/A160/A160-L/A160CDI/ A160CDI-L/A170CDI/A170CDI-L	175/65R15 M+S 185/55R15 M+S 195/50R15		5½ J x15 H2 5x112x66,5 ET 54		
	A 190 (92 kW) und A 210 (103 kW) nur LM-GuBräder zulässig! FZG-Schein beachten! Je nach Ausführung unterschiedliche Reifengrößen zulässig. 195/50R15 und 195/55R15 bei einigen Ausf. nur als Sommerbereifung zulässig.	Kugel sw 17 M12 x 1,5 x 20		€ 62,90		
						RDKS
		169	09/04-09/12	A-Klasse		
	Steilheck	153902	8245	ME 515049		
	A 150/ A 170/ A160 CDI/ A 180 CDI	185/65R15		6 J x15 H2 5x112x66,5 ET 44		
		Kugel sw 17 M14 x 1,5 x 26		€ 65,50		
						RDKS



A-Klasse			169		
MAGNA	Interio		IN 605 45 5 12	lichtsilber-lackiert / mattschwarz-lackiert	
	6 J x15 H2	185/65R15	ABE		
	5 x 112	195/60R15	ABE		
	ET 45	205/60R15	ABE		
RDKS	ASC; ASS; CUS; Huf 2.4; Huf 3.4; SE1C1; SE1C2; SE15; TTC; TTS		MK 307	IN	IN

A-Klasse			09/04-09/12	169		
Renner	ME 516017	8595	163322	Steilheck		
	6 J x16 H2	195/55R16		A 150/ A170/ A 200/ A 160 CDI/ 180 CDI/ A 200 CDI		
	5x112x66,5					
	ET 46					
RDKS	€ 76,60	Kugel sw 17 M14 x 1,5 x 26				



A-Klasse			169		
MAGNA	Celsio		CS 656 50 5 12	lichtsilber-lackiert	
	Tezzo		TZ 656 50 5 12	lichtsilber-lackiert / mattschwarz-lackiert	
	6½ J x16 H2	195/55R16	ABE		
	5 x 112	205/50R16	ABE		
ET 50					
RDKS	Celsio: ASC; ASS; CUC; Huf 2.4; Huf 3.4; Huf 3.5; SE1C1; SE1C2; SE15; TTC; TTS Tezzo: ASC; ASS; CUC; Huf 2.4; Huf 3.4; Huf 3.5; SE1C1; SE1C2; SE15; TTC		MK 307	CS	TZ

A-Klasse			10/12-	176, 245 G		
Renner	ME 515052	7620	155501	Steilheck		
	6½ J x15 H2	195/65R15		A 180/ A 160 CDI/ A 180 CDI		
	5x112x66,5					
	ET 47					
RDKS	€ 65,50	Kugel sw 17 M14 x 1,5 x 26		Serienrad mit Flow-Form-Felge. Nicht A 250!		



A-Klasse			10/12-	176, 245 G		
Renner	ME 516025	9732	166001	Steilheck		
	6½ J x16 H2	205/55R16		A 180/ A 200/ A220/ A 160 CDI/ A 180 CDI/ A 200 CDI/ A 220 CDI		
	5x112x66,5					
	ET 49					
RDKS	€ 76,60	Kugel sw 17 M14 x 1,5 x 26		Serienrad mit Flow-Form-Felge. Nicht A 250!		

		176, 245 G	A-Klasse		
		lichtsilber-lackiert		Celsio	CS 656 50 5 12
		lichtsilber-lackiert / mattschwarz-lackiert		Tezzo	TZ 656 50 5 12
		ABE	205/55R16	6½ J x16 H2	
				5 x 112	
				ET 50	
CS	TZ	MK 307	Celsio: ASC; ASS; CUC; Huf 2.4; Huf 3.4; Huf 3.5; SE1C1; SE1C2; SE15; TTC; TTS / OE: Schrader 3013 Tezzo: ASC; ASS; CUC; Huf 2.4; Huf 3.4; Huf 3.5; SE1C1; SE1C2; SE15; TTC / OE: Schrader 3013		RDKS

KRONPRINZ
MAGMA

		176, 245 G	A-Klasse		
		lichtsilber-lackiert / mattschwarz-lackiert		Interio	IN 706 45 5 12
		ABE	205/55R16	7 J x16 EH2+	
				5 x 112	
				ET 45	
IN	IN	MK 307	ASC; CUC; Huf 2.4; Huf 3.4; Huf 3.5; SE1C1; SE15 / OE: Schrader 3013		RDKS



KRONPRINZ
MAGMA

		176, 245 G	A-Klasse		
		lichtsilber-lackiert / mattschwarz-lackiert		Tezzo	TZ 757 50 5 12
		ABE	205/50R17 M+S	7½ J x17 H2	
		ABE	225/45R17	5 x 112	
		ABE	235/45R17	ET 50	
TZ	TZ	MK 307	ASC; ASS; CUC; Huf 2.4; Huf 3.4; Huf 3.5; SE1C1; SE1C2; SE15 / OE: Schrader 3013		RDKS

KRONPRINZ
MAGMA



		245	06/05-09/11	B-Klasse	
	Steilheck B 150/ B 170	153902	8245	ME 515049	
		195/65R15		6 J x15 H2	
		Kugel sw 17 M14 x 1,5 x 26		5x112x66,5	
				ET 44	
				€ 65,50	
				RDKS	

Renner

		245	B-Klasse		
		lichtsilber-lackiert / mattschwarz-lackiert		Interio	IN 605 45 5 12
		ABE	195/65R15 ❄	6 J x15 H2	
		ABE	205/60R15 ❄	5 x 112	
				ET 45	
IN	IN	MK 307	ASC; ASS; CUS; Huf 2.4; Huf 3.4; SE1C1; SE1C2; SE15; TTC; TTS		RDKS



KRONPRINZ
MAGMA

B-Klasse			06/05-09/11	245	
Renner	ME 516017	8595	163322	Steilheck	
	6 J x16 H2	205/55R16		B 150/ B 170/ B 200/ B 200 T/ B 180 CDI/ B 200 CDI	
	5x112x66,5				
	ET 46				
RDKS	€ 76,60	Kugel sw 17 M14 x 1,5 x 26			

B-Klasse				245		
MAGNA	Celsio	CS 656 50 5 12	lichtsilber-lackiert			
	Tezzo	TZ 656 50 5 12	lichtsilber-lackiert / mattschwarz-lackiert			
	6½ J x16 H2	205/55R16	⊛	ABE		
	5 x 112					
RDKS	ET 50					
RDKS	Celsio: ASC; ASS; CUC; Huf 2.4; Huf 3.4; Huf 3.5; SE1C1; SE1C2; SE15; TTC; TTS Tezzo: ASC; ASS; CUC; Huf 2.4; Huf 3.4; Huf 3.5; SE1C1; SE1C2; SE15; TTC			MK 307	CS	TZ

B-Klasse			10/11-	246, 245 G	
Renner	ME 515052	7620	155501	Steilheck	
	6½ J x15 H2	195/65R15		B 180 / B 160 CDI/ B 180 CDI	
	5x112x66,5				
	ET 47				
RDKS	€ 65,50	Kugel sw 17 M14 x 1,5 x 26		Serienrad mit Flow-Form-Felge. Nicht B 250! Nicht Electric Drive!	
RDKS	CUC; Huf 2.4; Huf 3.4; SE1C1; SE2C1; SE2C2; SE15 / OE: Schrader 3013				

B-Klasse			10/11-	246, 245 G	
Renner	ME 516025	9732	166001	Steilheck	
	6½ J x16 H2	205/55R16		B 180 / B 200/ B 220/ B 160 CDI/ B 180 CDI/ B 200 CDI/ B 220 CDI/ B 200 Natural Gas Drive	
	5x112x66,5				
	ET 49				
RDKS	€ 76,60	Kugel sw 17 M14 x 1,5 x 26		Serienrad mit Flow-Form-Felge. Nicht B 250! Nicht Electric Drive!	
RDKS	CUC; Huf 2.4; Huf 3.4; SE1C1; SE2C1; SE2C2 / OE: Schrader 3013				

B-Klasse				246, 245 G		
MAGNA	Celsio	CS 656 50 5 12	lichtsilber-lackiert			
	Tezzo	TZ 656 50 5 12	lichtsilber-lackiert / mattschwarz-lackiert			
	6½ J x16 H2	205/55R16	⊛	ABE		
	5 x 112					
RDKS	ET 50					
RDKS	Celsio: ASC; ASS; CUC; Huf 2.4; Huf 3.4; Huf 3.5; SE1C1; SE1C2; SE15; TTC; TTS / OE: Schrader 3013 Tezzo: ASC; ASS; CUC; Huf 2.4; Huf 3.4; Huf 3.5; SE1C1; SE1C2; SE15; TTC / OE: Schrader 3013			MK 307	CS	TZ



		246, 245 G	B-Klasse	
	IN	lichtsilber-lackiert / mattschwarz-lackiert	Interio	
			IN 706 45 5 12	
			ABE	205/55R16
		5 x 112		
				ET 45
		MK 307	ASC; CUC; Huf 2.4; Huf 3.4; Huf 3.5; SE1C1; SE1S / OE: Schrader 3013	
				RDKS

		246, 245 G	B-Klasse	
	TZ	lichtsilber-lackiert / mattschwarz-lackiert	Tezzo	
			TZ 757 50 5 12	
			ABE	205/50R17
	215/45R17 ❄	5 x 112		
				ET 50
		MK 307	ASC; ASS; CUC; Huf 2.4; Huf 3.4; Huf 3.5; SE1C1; SE1C2; SE1S / OE: Schrader 3013	
				RDKS

		X	09/12-	Citan	
	Transporter	108 CDI (55 kW) / 109 CDI (66 kW)	143675	6335	RE 514019
			185/70R14	5½ J x14 H2	
					4x100x60
	Für Fahrzeuge mit 4-Loch Anschluss.		Kegel sw 17 M14 x 1,5 x 25		€ 64,50
			ASS; CUC; Huf 3.5; SE1C1; SE1C2; SE2C1; SE1S; SE2S; TTS / OE: Schrader 3041		RDKS

		X	09/12-	Citan	
	Transporter	108 CDI (55 kW) / 109 CDI (66 kW) / 111 CDI (81 kW)	154574	7215	RE 515023
			195/65R15	6 J x15 H2	
					5x108x60
	Für Fahrzeuge mit 5-Loch Anschluss.		Kegel sw 17 M14 x 1,5 x 25		€ 75,00
			ASC; ASS; CUC; Huf 2.4; Huf 3.4; Huf 3.5; SE1C1; SE1C2; SE2C1; SE2C2; SE1S; SE2S; TTC / OE: Schrader 3041		RDKS

		203, 203 K, 203 CL	05/00-02/07	C-Klasse	
	Stufenheck, T-Modell, Sportcoupé	C 160 Sportcoupé/ C 180/ C 180 K/ C 200 K/ C 200 CGI K/ C 200 CDI/ C 220 CDI	152801	9005	ME 515013
			195/65R15	6½ J x15 H2	
					5x112x66,5
	Auch für Facelit ab 04/04-, wenn Radgröße in den FZG-Papieren eingetragen ist. Nur verwendbar, wenn 6½ x 15 ET 37 in den FZG-Papieren eingetragen ist! Einige Ausführungen nur 16 Zoll und einige Ausführungen nur LM-Räder.		Kugel sw 17 M12 x 1,5 x 20		€ 67,60
					RDKS



C-Klasse / CLC			203, 203 K, 203 CL	
MAGMA	Seismo		SO 706 38 5 12	lichtsilber-lackiert / matschwarz-lackiert
	Interio		IN 706 38 5 12	lichtsilber-lackiert / matschwarz-lackiert
	7 J x16 H2	205/55R16	ABE	
	5 x 112	225/45R16	ABE	
ET 38				
RDKS			Seismo: ASC; ASS; CUC; Huf 2.4; Huf 3.4; SE1C2; SE15; TTC; TTS Interio: ASC; CUC; Huf 2.4; Huf 3.4; Huf 3.5; SE1C1; SE15	
			MK 215	



C-Klasse (W204)			03/07-02/14	204
Stahl	ME 516022	8597	163324	Stufenheck
	6 J x16 H2	195/60R16		C 180 (115 kW)/ C 180 CDI (88 kW)/ C 200 CDI (100 kW)
	5x112x66,5			
	ET 39			
€ 76,60		Kugel sw 17 M14 x 1,5 x 26		Bis EGBE Nachtrag *28.
RDKS				



C-Klasse (W204)			03/07-02/14	204, 204K
Renner	ME 516024	9892	163004	Stufenheck, T-Modell
	7 J x16 H2	205/55R16		C 180 (115 kW)/ C 200 (135 kW)/ C 230 (150 kW)/ C 250 (150 kW)/ C 280 (170 kW)/ C 180 CDI (88 kW)/ C 200 CDI (100 kW)/ C 220 CDI (125 kW)/ C 250 CDI (150 kW)
	5x112x66,5			
	ET 43			
€ 80,30		Kugel sw 17 M14 x 1,5 x 26		Bis EGBE Nachtrag *28.
RDKS				

C-Klasse Coupé (W204)			03/11-11/15	204
Stahl	ME 516022	8597	163324	Coupé
	6 J x16 H2	195/60R16		C 180 (115 kW)
	5x112x66,5			
	ET 39			
€ 76,60		Kugel sw 17 M14 x 1,5 x 26		
RDKS				

C-Klasse Coupé (W204)			03/11-11/15	204
Renner	ME 516024	9892	163004	Coupé
	7 J x16 H2	205/55R16		C 180 (115 kW)/ C 200 (135 kW)/ C 250 (150 kW)/ C 220 CDI (120/125 kW)/ C 250 CDI (150 kW)
	5x112x66,5			
	ET 43			
€ 80,30		Kugel sw 17 M14 x 1,5 x 26		
RDKS			CUC; Huf 2.4; Huf 3.4	



		204, 204 K	C-Klasse / C-Klasse Combi / C-Klasse Coupé					
	CS		lichtsilber-lackiert	Celsio	CS 706 45 5 12	MAGMA		
				lichtsilber-lackiert / mattschwarz-lackiert	Interio		IN 706 45 5 12	
				204K nur Bereifung 205/55R16 / Achtung Bremsanlage beachten	ABE		195/60R16 ❄	7 J x16 EH2+
					ABE		205/55R16 ❄	
		MK 302	Celsio: ASC; CUC; Huf 3.4; Huf 3.5; SE1C1; SE15 Interio: ASC; CUC; Huf 2.4; Huf 3.4; Huf 3.5; SE1C1; SE15			RDKS		

		204, 204 K	C-Klasse / C-Klasse Combi / C-Klasse Coupé					
	TZ		lichtsilber-lackiert / mattschwarz-lackiert	Tezzo	TZ 756 42 5 12	MAGMA		
				Achtung / Bremsanlage beachten	ABE		205/55R16	7½ J x16 H2
							MK 302	ASC; ASS; CUC; Huf 2.4; Huf 3.4; Huf 3.5; SE1C1; SE1C2; SE15; TTC

		204, 204 K	C-Klasse / C-Klasse Combi / C-Klasse Coupé						
	TZ		lichtsilber-lackiert / mattschwarz-lackiert	Tezzo	TZ 757 50 5 12	MAGMA			
				Achtung / Bremsanlage beachten	ABE		205/50R17	7½ J x17 H2	
					ABE		215/45R17		5 x 112
					ABE		225/45R17		ET 50
		MK 302	ASC; ASS; CUC; Huf 2.4; Huf 3.4; Huf 3.5; SE1C1; SE1C2; SE15			RDKS			

		204	03/14-	C-Klasse (W205)		
	Stufenheck C160 (95 kW)/ C180 d (85 kW)/ C 180 (115 kW)/ C200 d (100 kW)	166201	8952	ME 516026		Stahl
		195/65R16		6 J x16 H2		
		205/60R16		5x112x66,5		
		Kugel sw 17 M14 x 1,5 x 26		€ 76,60		
		CUC; SE1C1; SE2C1 / OE: Schrader 3013				RDKS



		204	C-Klasse (Neues Modell)						
	CS		lichtsilber-lackiert	Celsio	CS 706 38 5 12	MAGMA			
				Baureihe W205 / Rad nur für Limousine	ABE		205/60R16	7 J x16 H2	
					ABE		205/60R16M+S		5 x 112
							ET 38		
		MK 302	ASC; CUC; Huf 3.4; Huf 3.5; SE1C1; SE15 / OE: Schrader 3013			RDKS			



C-Klasse (Neues Modell)				204, 204 K			
MAGNA	Tezzo		TZ 757 50 5 12		lichtsilber-lackiert / mattschwarz-lackiert		
	7½ J x17 H2	205/55R17 *	ABE	Baureihe W205			
	5 x 112	215/50R17 *	ABE				
	ET 50	225/50R17 *	ABE				
RDKS	ASC; ASS; CUC; Huf 2.4; Huf 3.4; Huf 3.5; SE1C1; SE1C2; SE15 / OE: Schrader 3013			MK 302	TZ	TZ	

C-Klasse Coupé (Neues Modell)					
MAGNA	in Vorbereitung			Baureihe W205	Radabbildung in Vorbereitung
RDKS					



CLA		04/13-	117, 245 G		
Renner	ME 515052	7620	155501	Coupé	
	6½ J x15 H2	195/65R15		CLA 180 BlueEFFICIENCY	
	5x112x66,5				
	ET 47				
	€ 65,50	Kugel sw 17 M14 x 1,5 x 26			
RDKS	CUC; Huf 2.4; Huf 3.4; SE1C1; SE2C1; SE2C2; SE15 / OE: Schrader 3013				



CLA		04/13-	117, 245 G		
Renner	ME 516025	9732	166001	Coupé	
	6½ J x16 H2	205/55R16		CLA 180/ CLA 180 BlueEFFICIENCY/ CLA 200/ CLA 200 CDI/ CLA 220 CDI	
	5x112x66,5				
	ET 49				
	€ 76,60	Kugel sw 17 M14 x 1,5 x 26		CLA 220 CDI nicht in Verbindung mit Sportpaket.	
RDKS	CUC; Huf 2.4; Huf 3.4; SE1C1; SE2C1; SE2C2 / OE: Schrader 3013				



CLA				117, 245 G				
MAGNA	Celsio		CS 706 45 5 12		lichtsilber-lackiert			
	Interio		IN 706 45 5 12					lichtsilber-lackiert / mattschwarz-lackiert
	7 J x16 EH2+	205/55R16	ABE					
	5 x 112	215/50R16 *	ABE					
	ET 45							
RDKS	Celsio: ASC; CUC; Huf 3.4; Huf 3.5; SE1C1; SE15 / OE: Schrader 3013 Interio: ASC; CUC; Huf 2.4; Huf 3.4; Huf 3.5; SE1C1; SE15 / OE: Schrader 3013			MK 307	CS	IN		

		117, 245 G	CLA		
		lichtsilber-lackiert / mattschwarz-lackiert		Tezzo	TZ 757 50 5 12
			ABE	205/50R17 M+S	7½ J x17 H2 5 x 112 ET 50
			ABE	215/45R17 ❄	
			ABE	225/45R17	
TZ	TZ	MK 307	ASC; ASS; CUC; Huf 2.4; Huf 3.4; Huf 3.5; SE1C1; SE1C2; SE1S; OE: Schrader 3013		RDKS

		209	08/05-03/09	CLK	
	Coupé, Cabrio	152801	9005	ME 515013	
	200K (120 kW) / 220 CDI (100/110 kW) / 200 CGI (125 kW)	195/65R15		6½ J x15 H2 5x112x66,5 ET 37	
	FZG-Schein beachten! Rad nicht für alle Ausführungen verwendbar!	Kugel sw 17 M12 x 1,5 x 20		€ 67,60	
					RDKS

		208, 209	CLK		
		lichtsilber-lackiert / mattschwarz-lackiert		Seismo	SO 706 38 5 12
		lichtsilber-lackiert / mattschwarz-lackiert		Interio	IN 706 38 5 12
			ABE	205/55R16	7 J x16 H2 5 x 112 ET 38
			ABE	225/45R16	
SO	IN	MK 215	Seismo: ASC; ASS; CUC; Huf 2.4; Huf 3.4; SE1C2; SE1S; TTC; TTS Interio: ASC; CUC; Huf 2.4; Huf 3.4; Huf 3.5; SE1C1; SE1S		RDKS

		216	CL-Klasse		
		lichtsilber-lackiert		Celsio	CS 807 35 5 12
		lichtsilber-lackiert / mattschwarz-lackiert		Interio	IN 807 35 5 12
			ABE	235/55R17	8 J x17 EH2+ 5 x 112 ET 35
			ABE	255/50R17	
CS	IN	MK 307	Celsio: ASC; ASS; CUC; Huf 2.4; Huf 3.4; Huf 3.5; SE1C1; SE1S; OE: Schrader 3011 Interio: ASC; CUC; Huf 3.5; SE1C1; SE1S; OE: Schrader 3011		RDKS

		218, 219, 219 AMG	CLS-Klasse		
		lichtsilber-lackiert / mattschwarz-lackiert		Tezzo	TZ 858 30 5 12
		Typ 219 mit 350/378KW nur mit Bereifung 245/40R18M+S	ABE	245/40R18	8½ J x18 H2 5 x 112 ET 30
			ABE	245/40R18 M+S	
TZ	TZ	MK 307	ASC; ASS; CUC; Huf 2.4; Huf 3.4; Huf 3.5; SE1C1; SE1C2; SE1S; TTC		RDKS

E-Klasse		03/02-03/09	211, 211 K	
Stahl	*ME 516012	9865	163202	Stufenheck, T-Modell E200K/E240/E320/E200CDi/E220CDi/ E270CDi/E320CDi/E200NGT
	7½ J x16 H2	225/55R16		
	5x112x66,5 ET 42			
RDKS	€ 88,70	Kugel sw 17 M14 x 1,5 x 26		RDKS BERU, kurzer Kopf (grün/RDV002) nur bis Baujahr 04/2005.



E-Klasse / E-Klasse Combi			212, 212 K		
MAGNA	Tezzo	TZ 756 42 5 12	lichtsilber-lackiert / mattschwarz-lackiert		
	7½ J x16 H2	205/60R16 *	ABE	Bereifung 205/60R16 + 215/55R16 nur für Modell Limousine (Typ 212)	
	5 x 112	215/55R16 *	ABE		
	ET 42	225/55R16 *	ABE		
RDKS	ASC; ASS; CUC; Huf 2.4; Huf 3.4; Huf 3.5; SE1C1; SE1C2; SE1S; TTC / OE: Schrader 3013			MK 307	



E-Klasse / E-Klasse Combi			212, 212 K		
MAGNA	Seismo	SO 807 48 5 12	lichtsilber-lackiert / mattschwarz-lackiert		
	8 J x17 H2	205/50R17 *	ABE	Bereifung 205/50R17 nur für Modell Limousine (Typ 212)	
	5 x 112	225/50R17 *	ABE		
	ET 48	245/45R17	ABE		
RDKS	ASC; ASS; CUC; Huf 2.4; Huf 3.4; Huf 3.5; SE1C1; SE1C2; SE1S; TTC / OE: Schrader 3013			MK 313	





E-Klasse Coupé / E-Klasse Cabrio			207		
MAGNA	Celsio	CS 706 38 5 12	lichtsilber-lackiert		
	Interio	IN 706 38 5 12	lichtsilber-lackiert / mattschwarz-lackiert		
	7 J x16 EH2+	205/55R16 *	ABE		
	5 x 112	215/55R16 *	ABE		
ET 38	225/50R16 *	ABE			
RDKS	Celsio: ASC; CUC; Huf 3.4; Huf 3.5; SE1C1; SE1S Interio: ASC; CUC; Huf 2.4; Huf 3.4; Huf 3.5; SE1C1; SE1S			MK 302	



E-Klasse		03/16-	
Stahl	INFO		Stufenheck
			INFO
RDKS			Radabbildung in Vorbereitung



		E-Klasse (W213)		
Radabbildung in Vorbereitung				in Vorbereitung
				RDKS



245 G		03/14-	GLA	
	SUV	176102	9787	ME 517006
	GLA 180/ GLA 200/ GLA 250/ GLA 200 CDI/ GLA 220 CDI/ 4-matic	215/60R17		6½ J x17 H2 5x112x66,5 ET 38
	Serienrad mit Flow-Form-Felge.	Kugel sw 17 M14 x 1,5 x 26		€ 95,70
		CUC; Huf 2.4; Huf 3.4; SE1C1; SE2C1; SE2C2 / OE: Schrader 3013		
				RDKS

245 G		GLA		
		lichtsilber-lackiert	Celsio	CS 808 45 5 12
	CS		ABE	225/50R18
			ABE	235/50R18
			ABE	245/45R18
	MK 307	ASC; ASS; CUC; Huf 2.4; Huf 3.4; Huf 3.5; SE1C1; SE1C2; SE1S; TTC / OE: Schrader 3013		
				RDKS



204X		GLC		
Radabbildung in Vorbereitung				in Vorbereitung
				RDKS



204X		GLK		
		lichtsilber-lackiert	Celsio	CS 808 45 5 12
	CS		ABE	235/50R18
	MK 302	ASC; ASS; CUC; Huf 2.4; Huf 3.4; Huf 3.5; SE1C1; SE1C2; SE1S; TTC / OE: Schrader 3011		
				RDKS



M-Klasse				164	
MAGNA	Interio		IN 808 50 5 12	lichtsilber-lackiert / mattschwarz-lackiert	
	8 J x18 EH2+	235/60R18	ABE		
	5 x 112	245/55R18	ABE		
	ET 50				
RDKS	CUC; Huf 3.4; SE1C1; SE1S		MK 307	IN	IN



M-Klasse				166	
MAGNA	Interio		IN 807 50 5 12	lichtsilber-lackiert / mattschwarz-lackiert	
	8 J x17 EH2+	235/65R17	ABE		
	5 x 112	245/65R17	ABE		
	ET 50				
RDKS	ASC; CUC; Huf 3.5; SE1C1; SE1S / OE: Schrader 3013		MK 307	IN	IN



M-Klasse				166	
MAGNA	Celsio		CS 808 45 5 12	lichtsilber-lackiert	
	8 J x18 EH2+	235/60R18	ABE		CS
	5 x 112				
	ET 45				
RDKS	ASC; ASS; CUC; Huf 2.4; Huf 3.4; Huf 3.5; SE1C1; SE1C2; SE1S; TTC / OE: Schrader 3013		MK 307		



R-Klasse				251	
MAGNA	Interio		IN 808 50 5 12	lichtsilber-lackiert / mattschwarz-lackiert	
	8 J x18 EH2+	235/55R18	ABE		
	5 x 112				
	ET 50				
RDKS	CUC; Huf 3.4; SE1C1; SE1S / OE: Schrader 3011 Wall II		MK 307	IN	IN

S-Klasse				221	
MAGNA	Celsio		CS 808 35 5 12	lichtsilber-lackiert	
	Interio		IN 808 35 5 12	lichtsilber-lackiert / mattschwarz-lackiert	
	8 J x18 EH2+	235/50R18	ABE		
	5 x 112	255/45R18	ABE		
	ET 35				
RDKS	Celsio: ASC; ASS; CUC; Huf 2.4; Huf 3.4; Huf 3.5; SE1C1; SE1C2; SE1S; TTC Interio: CUC; Huf 3.4; SE1C1; SE1S		MK 307	CS	IN



		221	S-Klasse (Neues Modell)			
 TZ	 TZ	lichtsilber-lackiert / mattschwarz-lackiert		Tezzo	TZ 858 30 5 12	
		Baureihe W222 / Achtung Bremsanlage beachten		ABE	255/45R18	8½ J x18 H2 5 x 112 ET 30
		MK 307		ASC; ASS; CUC; Huf 2.4; Huf 3.4; Huf 3.5; SE1C1; SE1C2; SE1S; TTC / OE: Schrader 3013		
					MAGMA	
					RDKS	

		170, 171	SLK		
 SO	 IN	lichtsilber-lackiert / mattschwarz-lackiert		Seismo	SO 706 38 5 12
		lichtsilber-lackiert / mattschwarz-lackiert		Interio	IN 706 38 5 12
		Achtung / Bremsanlage beachten		ABE	205/55R16 *
MK 215		Seismo: ASC; ASS; CUC; Huf 2.4; Huf 3.4; SE1C2; SE1S; TTC; TTS Interio: ASC; CUC; Huf 2.4; Huf 3.4; Huf 3.5; SE1C1; SE1S			
					MAGMA
					RDKS

		172	SLK			
 IN	 IN	lichtsilber-lackiert / mattschwarz-lackiert		Interio	IN 706 38 5 12	
				ABE	205/55R16 *	7 J x16 EH2+ 5 x 112 ET 38
				ABE	215/50R16 *	
		ABE	225/50R16			
MK 302		ASC; CUC; Huf 2.4; Huf 3.4; Huf 3.5; SE1C1; SE1S / OE: Schrader 3013			MAGMA	
					RDKS	

		172	SLK		
 IN	 TZ	lichtsilber-lackiert / mattschwarz-lackiert		Interio	IN 807 35 5 12
		lichtsilber-lackiert / mattschwarz-lackiert		Tezzo	TZ 807 35 5 12
				ABE	205/50R17 *
		ABE	215/45R17 *		
		ABE	225/45R17 *		
MK 302		Interio: ASC; CUC; Huf 3.5; SE1C1; SE1S / OE: Schrader 3013 Tezzo: ASC; ASS; CUC; Huf 2.4; Huf 3.4; Huf 3.5; SE1C1; SE1C2; SE1S; TTC / OE: Schrader 3013			MAGMA
					RDKS

		SLC			
Radabbildung in Vorbereitung				in Vorbereitung	MAGMA
					RDKS





SL-Klasse			231		
MAGNUM	Tezzo		TZ 858 30 5 12	lichtsilber-lackiert / mattschwarz-lackiert	
	8½ J x18 H2	255/40R18	☼	ABE	
	5 x 112				
	ET 30				
RDKS	ASC; ASS; CUC; Huf 2.4; Huf 3.4; Huf 3.5; SE1C1; SE1C2; SE15; TTC / OE: Schrader 3013			MK 307	

Sprinter			01/00-04/06	902, 903, C, D	
Stahl	ME 615016	8555	154517	Transporter	
	6 J x15 H2	195/70R15		208CDI/211CDI/213CDI/214/216CDI/308CDI/	
	5x130x84	225/70R15		311CDI/313CDI/314/316CDI	
	ET 75				
€ 84,50	Kugel sw 19 M14 x 1,5 x 34		Für Singlebereifung		
RDKS					

Sprinter			05/06-06/13	906*	
Stahl	ME 616013	9487	163323	Transporter	
	6½ J x16 H2	205/75R16C		216/ 224/ 209 CDI/ 210 CDI/ 211 CDI/ 213 CDI /215 CDI/ 216 CDI/	
	6x130x84	225/75R16C		218 CDI/ 219 CDI/ 314/ 316/ 324/ 309 CDI/ 310 CDI/ 311 CDI/ 313	
	ET 62	235/65R16C		CDI/ 315 CDI/ 316 CDI/ 318 CDI/ 319 CDI/ 316 NGT	
€ 92,40	Kugel sw 19 M14 x 1,5 x 25		FZG-Schein muss unbedingt beachtet werden: Je nach Ausführung und Motorisierung sind unterschiedliche Reifenabmessungen vorgeschrieben.		
RDKS					

Sprinter			07/13-	906*	
Stahl	ME 616037		163398	Transporter	Radabbildung in Vorbereitung
	5½ J x16 H2	205/75R16C		210 CDI/ 213 CDI/ 216 CDI/ 219 BlueTEC/ 216	
	6x130x84				
	ET 51				
€ 92,40			Rad für Singlebereifung.		
RDKS	OE: Schrader 3011				

Sprinter			07/13-	906*	
Stahl	ME 616036	7870	163373	Transporter	
	5½ J x16 H2	195/75R16C		516/ 524/ 509 CDI/ 510 CDI/ 511 CDI/ 513 CDI/ 515 CDI/ 516 CDI/	
	6x205x161	205/75R16C		518 CDI/ 519 CDI/ 519 BlueTEC/ 516/ 516 NGT	
	ET 109,5				
€ 142,80			HMA 117. Rad für Zwillingsbereifung. Auch Vorderachse. FZG-Schein muss unbedingt beachtet werden: Je nach Ausführung und Motorisierung sind unterschiedliche Reifenabmessungen vorgeschrieben.		
RDKS	OE: Schrader 3011				

		906*	07/13-	Sprinter	
	Transporter	163323	9487	ME 616013	Stahl
	216/ 224/ 209 CDI/ 210 CDI/ 211 CDI/ 213 CDI/ 215 CDI/ 216 CDI/ 218 CDI/ 219 CDI/ 219 BlueTEC/ 314/ 316/ 324/ 309 CDI/ 310 CDI/ 311 CDI/ 313 CDI/ 315 CDI/ 316 CDI/ 318 CDI/ 319 CDI/ 319 BlueTEC/ 316 NGT	205/75R16C		6½ J x16 H2	
		225/75R16C		6x130x84	
		235/65R16C		ET 62	
		Kugel sw 19 M14 x 1,5 x 25		€ 92,40	
		CUC; Huf 2.4; Huf 3.4 / OE: Schrader 3011			RDKS
		639, 639/4, 639/5	09/03-	Viano	
	Van	163320	9095	ME 616016	Stahl
	3,0i (140 kW)/ 3,2i (160kW)/ 2,0 CDI (80 kW)/ 2,2 CDI (110 kW)	195/65R16		6 J x16 H2	
				5x112x66,5	
				ET 54	
		Kugel sw 17 M14 x 1,5 x 26,5		€ 92,40	
		ASC; ASS; CUC; Huf 3.5; SE1C1; SE1C2; SE2C1; SE2C2; SE1S; SE2S; TTC			RDKS
		639, 639/4, 639/5	09/03-	Viano	
	Van	163321	9897	ME 616017	Stahl
	3,0i (140 kW)/ 3,2i (160 kW)/ 2,0 CDI (80 kW)/ 2,2 CDI (85/110 kW)	205/65R16		6½ J x16 H2	
	3,5i (170 kW)	225/60R16		5x112x66,5	
		205/65R16 M+S		ET 60	
		Kugel sw 17 M14 x 1,5 x 26,5		€ 98,80	
		ASC; ASS; CUC; Huf 3.5; SE1C1; SE1C2; SE2C1; SE2C2; SE1S; SE2S			RDKS
		639, 639/4, 639/5	09/03-09/14	Vito II	
	Kombi, Transporter	163320	9095	ME 616016	Stahl
	119 (140 kW)/ 109 CDI (65 kW)/ 111 CDI (80/85 kW)/ 115 CDI (110 kW)	195/65R16		6 J x16 H2	
				5x112x66,5	
				ET 54	
	FZG-Schein beachten. Vito 122 (160 kW) Kastenwagen und Mixto nur ME 616017.	Kugel sw 17 M14 x 1,5 x 26,5		€ 92,40	
		ASC; ASS; CUC; Huf 3.5; SE1C1; SE1C2; SE2C1; SE2C2; SE1S; SE2S; TTC			RDKS
		639, 639/4, 639/5	09/03-09/14	Vito II	
	Kombi, Transporter	163321	9897	ME 616017	Stahl
	119 (140 kW)/ 122 (160 kW)/ 109 CDI (65 kW)/ 111 CDI (80 kW)/ 113 CDI (100 kW)/ 115 CDI (110 kW)/ 120 CDI/ 4x4	205/65R16		6½ J x16 H2	
	123 (170 kW)	225/60R16		5x112x66,5	
		205/65R16 M+S		ET 60	
	FZG-Schein beachten. Nur zulässig bis max. 1800 kg Achlast.	Kugel sw 17 M14 x 1,5 x 26,5		€ 98,80	
		ASC; ASS; CUC; Huf 3.5; SE1C1; SE1C2; SE2C1; SE2C2; SE1S; SE2S			RDKS

Vito II / Viano			639, 639/2, 639/4, 639/5	
MAGNUM	Celsio	CS 656 50 5 12	lichtsilber-lackiert	
	Tezzo	TZ 656 50 5 12	lichtsilber-lackiert / mattschwarz-lackiert	
	6½ J x16 H2	195/65R16C ❄	ABE	Achslast beachten !
	5 x 112	205/65R16C ❄	ABE	
ET 50	225/60R16 ❄	ABE		
RDKS	Celsio: ASC; ASS; CUC; Huf 2.4; Huf 3.4; Huf 3.5; SE1C1; SE1C2; SE1S; TTC; TTS Tezzo: ASC; ASS; CUC; Huf 2.4; Huf 3.4; Huf 3.5; SE1C1; SE1C2; SE1S; TTC			MK 307



CS



TZ

Vito III			10/14-	639/2, 639/4
Stahl	ME 516027	6501	163429	Kastenwagen, Mixto, Tourer
	6½ J x16 H2	195/65R16C		109 CDI/ 111 CDI/ 114 CDI
	5x112x66,5	205/65R16C		109 CDI/ 111 CDI/ 114 CDI/ 116 CDI
	ET 52	225/60R16C		
	€ 98,80	FZG-Schein muss unbedingt beachtet werden: Je nach Ausführung und Motorisierung sind unterschiedliche Reifenabmessungen vorgeschrieben. Einige Ausführungen nur 17 Zoll.		
RDKS	ASC; ASS; CUC; CUS; Huf 2.4; Huf 3.4; Huf 3.5; SE1C1; SE1C2; SE2C2; SE1S; SE2S; TTC			



Vito III			10/14-	639/2, 639/4, 639/5
Stahl	ME 517007	9002	175303	Kastenwagen, Mixto, Tourer
	6½ J x17 H2	225/55R17		109 CDI/ 111 CDI/ 114 CDI/ 116 CDI/ 119 BlueTEC
	5x112x66,5			
	ET 50			
	€ 109,00	FZG-Schein muss unbedingt beachtet werden: Je nach Ausführung und Motorisierung sind unterschiedliche Reifenabmessungen vorgeschrieben.		
RDKS	ASC; ASS; CUC; Huf 2.4; SE1C1; SE1C2; SE1S; TTC; TTS			





V-Klasse			05/14-	639/2, 639/4
Stahl	ME 516027	6501	163429	Van
	6½ J x16 H2	195/65R16C		V 200 d (100 kW)
	5x112x66,5	205/65R16C		V 200 d (100 kW)/ V 220 d (120 kW)
	ET 52	225/60R16C		V 250 d (140 kW)/ V 200 d (100 kW)/ V 220 d (120 kW)
	€ 98,80	FZG-Schein muss unbedingt beachtet werden: Je nach Ausführung und Motorisierung sind unterschiedliche Reifenabmessungen vorgeschrieben. Einige Ausführung nur 17 Zoll.		
RDKS	ASC; ASS; CUC; CUS; Huf 2.4; Huf 3.4; Huf 3.5; SE1C1; SE1C2; SE2C2; SE1S; SE2S; TTC			



V-Klasse			05/14-	639/2, 639/4, 639/5
Stahl	ME 517007	9002	175303	Van
	6½ J x17 H2	225/55R17		V 200 d (100 kW)/ V 220 d (120 kW)/ V 250 d (140 kW)
	5x112x66,5			
	ET 50			
	€ 109,00			
RDKS	ASC; ASS; CUC; Huf 2.4; SE1C1; SE1C2; SE1S; TTC; TTS			



		639/2	V-Klasse (Neues Modell)		
		lichtsilber-lackiert / mattschwarz-lackiert		Tezzo	TZ 757 50 5 12
		Achslasten / Bremsanlage und Serienbereifung beachten		ABE	225/55R17
		MK 307		ASC ; ASS ; CUC ; Huf 2.4 ; Huf 3.4 ; Huf 3.5 ; SE1C1 ; SE1C2 ; SE1S	

**KRONPRINZ
MAGMA**

RDKS

MINI



R50, MINI, MINI-N, UKL-C, UKL-K, UKL-L		10/01-02/14	One / Cooper	
	Schrägheck, Cabrio	154541	8155	BM 515015
	1,4i (70 kW) / 1,6i (55/66/72/85/88/90 kW) / 1,4 D (55 kW) / 1,6 D (66/80/82 kW)	175/65R15		5½ J x15 H2 4x100x56 ET 45 € 70,80

Stahl

RDKS

MINI-N, UKL-K		11/07-	Clubman	
	Kombi	154541	8155	BM 515015
	1,4i (70 kW) / 1,6i (72/85/88/90 kW) / 1,6 D (66/80/82 kW)	175/65R15		5½ J x15 H2 4x100x56 ET 45 € 70,80
		ASC ; CUC ; Huf 2.4 ; Huf 3.4 / 0E: Huf		RDKS

Stahl

R50, Mini, Mini-N, UKL-C, UKL-L, UKL-K, UKLB-L		One / Cooper / Cabrio / Clubman			
		lichtsilber-lackiert / mattschwarz-lackiert		Seismo	SO 605 38 4 00
		lichtsilber-lackiert / mattschwarz-lackiert		Interio	IN 605 38 4 00
ab 09/2006 MK 503		ABE	175/65R15	6 J x15 H2 4 x 100 ET 38	RDKS
		ABE	185/60R15		
MK 211 / MK 503		Seismo: ASC ; ASS ; Huf 2.4 ; Huf 3.4 ; SE1C1 ; SE1C2 ; SE1S ; TTC Interio: ASC ; ASS ; CUS ; Huf 2.4 ; Huf 3.4 ; SE1C1 ; SE1C2 ; SE1S ; TTC ; TTS			

**KRONPRINZ
MAGMA**

Clubman (Neues Modell)			
KRONPRINZ MAGMA	in Vorbereitung		Radabbildung in Vorbereitung
RDKS			

One / Cooper / Cabrio / Coupé / Clubman / Cooper S / Roadster		R50, Mini, Mini-N, UKL-C, UKL-L, UKL-K, UKLB-L	
KRONPRINZ MAGMA	Interio	IN 706 45 4 00	lichtsilber-lackiert / mattschwarz-lackiert
	7 J x16 EH2+	195/50R16	TÜV
	4 x 100	195/55R16	TÜV
	ET 45		
RDKS		ASC; CUC; Huf 2.4; Huf 3.4; Huf 3.5; SE1C1; SE1S	MK 211 / MK 503



One / Cooper		03/14-	UKL-L
Renner	BM 515019	7605	155701
	5½ J x15 H2	175/65R15	Schrägheck
	5x112x66,5		1,2i (55/75 kW)/ 1,5i (100 kW)/ 1,5D (70/85 kW)
	ET 46		
RDKS		€ 70,80	Nicht Cooper S/ SD/ JCW!
RDKS		ASS; CUC; Huf 2.4; Huf 3.4; Huf 3.5; SE1C1; SE1C2; SE2C1; SE2C2; SE1S; SE2S / OE: VDO S180052056Z	





One / Cooper (Neues Modell)		UKL-L	
KRONPRINZ MAGMA	Tezzo	TZ 656 50 5 12	lichtsilber-lackiert / mattschwarz-lackiert
	6½ J x16 H2	185/55R16	ABE
	5 X 112	185/55R16 M+S	ABE
	ET 50	195/55R16	TÜV
RDKS		ASC; ASS; CUC; Huf 2.4; Huf 3.4; Huf 3.5; SE1C1; SE1C2; SE1S; TTC / OE: VDO S180052056Z	MK 504



Countryman		09/10-	UKL-N1, UKL-X
Stahl	BM 516024	8157	163327
	6½ J x16 H2	195/60R16 M+S	SUV
	5x120x72,5		1,6i (72/85/88/90/120/135/140/160 kW)/ 1,6 D (66/82/105 kW)/ 2,0 D (82/100/105 kW)
	ET 46	205/60R16	1,6i (72/85/88/90 kW)/ 1,6 D (66/82 kW)/ 2,0 D (82 kW)
RDKS		€ 80,80	
RDKS		ASC; ASS; CUC; CUS; Huf 2.4; Huf 3.4; Huf 3.5; SE2S; TTC / OE: Huf 100055	





		UKL-C/X	03/13-	Paceman	
	SUV	163327	8157	BM 516024	Stahl
	1,6i (90/140/160 kW)/ 1,6 D (82/105 kW)/ 2,0 D (105 kW)	195/60R16 M+S		6½ J x16 H2	
	1,6i (90 kW)/ 1,6 D (82 kW)	205/60R16		5x120x72,5	
				ET 46	
				€ 80,80	
ASC; ASS; CUC; CUS; Huf 2.4; Huf 3.4; Huf 3.5; SE2S; TTC					RDKS

		UKL/X, UKL-C/X	Countryman / Paceman		
		lichtsilber-lackiert	Celsio	CS 706 45 5 20	MAGMA
		lichtsilber-lackiert / mattschwarz-lackiert	Interio	IN 706 45 5 20	
CS	IN	ABE	195/60R16 M+S ❄	7 J x16 EH2+	MAGMA
			TÜV		
				5 x 120	
				ET 45	
MK 403		Celsio: ASC; CUC; Huf 3.4; Huf 3.5; SE1C1; SE1S / OE: Huf 100055 Interio: ASC; CUC; Huf 2.4; Huf 3.4; Huf 3.5; SE1C1; SE1S / OE: Huf 100055			RDKS

MITSUBISHI

		GAO	07/10-	ASX	
	SUV	163404	9427	MT 516005	Stahl
	1,6 MIVEC (86 kW)/ 1,6 DI-D (84 kW)/ 1,8 DI-D (110 kW)/ 2,2 DI-D (110 kW)/ 2WD/ 4WD	215/65R16		6½ J x16 H2	
				5x114,3x67	
				ET 46	
			Kegel sw 21 M12 x 1,5/H17	€ 90,90	
ASC; ASS; CUC; CUS; Huf 2.4; Huf 3.4; Huf 3.5; SE1C1; SE1C2; SE2C2; SE1S; SE2S / OE: VDO S180052094Z					RDKS

		GAO	ASX		
		lichtsilber-lackiert	Celsio	CS 656 40 5 14	MAGMA
		lichtsilber-lackiert / mattschwarz-lackiert	Tezzo	TZ 656 40 5 14	
CS	TZ	ABE	215/60R16 ❄	6½ J x16 H2	MAGMA
			ABE		
				5 x 114,3	
				ET 40	
MK 047		Celsio: ASC; ASS; CUC; Huf 2.4; Huf 3.4; Huf 3.5; SE1C1; SE1C2; SE1S; TTC; TTS Tezzo: ASC; ASS; CUC; Huf 2.4; Huf 3.4; Huf 3.5; SE1C1; SE1C2; SE1S; TTC / OE: VDO S180052094Z			RDKS

Colt		05/04-03/13	Z30	
Stahl	MC 514001	6670	143635	Schrägheck
	5½ J x14 H2	175/65R14		1,1i (55 kW)/ 1,3i (70 kW)/ 1,5 DI-D (50/70 kW)
	4x114,3x67	175/65R14 M+S		1,5i (80 kW)
	ET 46			
€ 66,00		Kegel sw 21 M12 x 1,5/H17		
RDKS				



Colt		05/04-03/13	Z30, Z3B	
Stahl	MC 515005	7960	154632	Schrägheck, Cabrio
	6 J x15 H2	185/55R15 M+S		1,1i (55 kW)/ 1,3i (70 kW)/ 1,5i (80 kW)/
	4x114,3x67	195/50R15		1,5 CZT (110 kW)/ 1,5 DI-D (50/70 kW)
	ET 46			
€ 79,20		Kegel sw 21 M12 x 1,5/H17		FZG-Schein beachten: Je nach Ausführung unterschiedliche Reifengrößen zulässig.
RDKS				

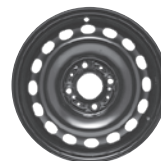

Colt / Cabrio			Z30, Z3B		
MAGNNA	Seismo	SO 605 44 4 14	lichtsilber-lackiert / mattschwarz-lackiert		
	6 J x15 H2	185/55R15*	ABE	*185/55R15 nur wenn Serie	
	4 x 114,3	185/55R15 M+S ☼	ABE		
	ET 44	195/50R15	ABE		
RDKS ASC; ASS; Huf 2.4; Huf 3.4; SE1C1; SE1C2; SE1S; TTC			MK 046	SO	SO





i-MiEV		01/11-	HA0, HAV	
Stahl	PS 515049	7160	154537	Schrägheck
	4 J x15 H2	145/65R15		Elektro (35 kW)
	4x100x56			
	ET 35			
€ 82,90		Kegel sw 21 M12 x 1,5/H17		Nur für die Vorderachse zulässig!
RDKS				





i-MiEV		01/11-	HA0, HAV	
Stahl	PS 515050	7235	154538	Schrägheck
	5 J x15 H2	175/55R15		Elektro (35 kW)
	4x100x54			
	ET 35			
€ 82,90		Kegel sw 21 M12 x 1,5/H17		Nur für die Hinterachse zulässig!
RDKS ASC; ASS; CUC; CUS; Huf 2.4; Huf 3.4; Huf 3.5; SE1S; TTC				





		CV0	02/08-	Lancer	
	Stufenheck	163402	9228	MT 516004	Stahl
	1,8i (105 kW) / 2,0 DI-D (103 kW)	205/60R16		6½ JJ x16 CH 5x114,3x67 ET 46	
		Kegel sw 21 M12 x 1,5/H17		€ 86,10	RDKS
		ASC; ASS; CUC; Huf 2.4; Huf 3.4; Huf 3.5; SE1C1; SE1C2; SE2C2; SE1S; SE2S / OE: VDO S180052094Z			

		CW0, CWB	02/07-08/12	Outlander II	
	SUV	163401	9407	MT 516003	Stahl
	2,4i (125 kW) / 2,0 DI-D (103 kW) / 2,2 DI-D (115 kW)	215/70R16		6½ JJ x16 CH 5x114,3x67 ET 38	
		Kegel sw 21 M12 x 1,5/H17		€ 90,90	RDKS

		CW0, CWB	Outlander II			
		lichtsilber-lackiert / mattschwarz-lackiert		Tezzo	TZ 656 40 5 14	MAGMA
				ABE	215/70R16	
				ABE	225/65R16	5 x 114,3
				ABE	235/60R16	ET 40
TZ	TZ	MK 047	ASC; ASS; CUC; Huf 2.4; Huf 3.4; Huf 3.5; SE1C1; SE1C2; SE1S; TTC			RDKS

		CW0	09/12-	Outlander III	
	SUV	163339	9657	PS 516020	Stahl
	2,0i (110 kW) / 2,2 DI-D (110 kW)	215/70R16		6½ J x16 CH 5x114,3x67 ET 38	
				€ 90,90	RDKS
		ASC; ASS; CUC; Huf 2.4; Huf 3.4; Huf 3.5; SE1C1; SE1C2; SE2C2; SE1S; SE2S; TTS / OE: VDO S180052094Z			

		CW0, CWB	Outlander III			
		lichtsilber-lackiert / mattschwarz-lackiert		Tezzo	TZ 656 40 5 14	MAGMA
				ABE	215/70R16	
				ABE	225/65R16	5 x 114,3
				ABE	235/60R16	ET 40
TZ	TZ	MK 047	ASC; ASS; CUC; Huf 2.4; Huf 3.4; Huf 3.5; SE1C1; SE1C2; SE1S; TTC / OE: VDO S180052094Z			RDKS

Space Star		04/13-	A00
Stahl	MT 514013	5215	143607
	4½ J x14 H2	165/65R14	
	4x100x56	1,0 MIVEC (52 kW)/ 1,2 MIVEC (59 kW)	
	ET 46		
	€ 58,70		
RDKS	ASC ; ASS ; CUC ; CUS ; Huf 2.4 ; Huf 3.4 ; Huf 3.5 ; SE1S ; SE2S / OE: VDO S180052094Z		



NISSAN

Almera Tino		09/00-02/06	V10
Stahl	*NI 515005	8415	154642
	6 J x15 CH	195/65R15	
	5x114,3x66	1,8i (84 kW)/2,0CVT (100 kW)/2,2 DI (81 kW)	
	ET 40		
	€ 79,80	Kegel sw 21 M12 x 1,25/H16	
RDKS			



Cabstar		05/07-	F24
Stahl	RE 615005		154605
	5 J x15 H2	195/70R15	
	5x170x130	2,5D (90/100 kW)/ 3,0D (110 kW)	
	ET 106,5		
	€ 89,00		
RDKS	OE: VDO		



Evalia		05/11-10/14	M20M, M20N
Stahl	*NI 614001	6375	143749
	5½ J x14 CH	175/70R14C	
	4x114,3x66	1,6i 16V (81kW)/ 1,5 dCi (66/81 kW)	
	ET 45		
	€ 67,60	Kegel sw 21 M12 x 1,5/H17	
RDKS	ASC ; ASS ; CUC ; Huf 2.4 ; Huf 3.4 ; Huf 3.5 ; SE1C1 ; SE1C2 ; SE2C1 ; SE2C2 ; SE1S ; SE2S ; TTC / OE: VDO S180052048Z		



		M20M, M20N	11/14-	Evalia
	Van		143750	NI 614002
	1,6i 16V (81kW)/ 1,5 dCi (66/81 kW)		175/70R14C	5½ J x14 CH 4x114,3x66 ET 45
	Für TPMS modifiziertes Rad. Ersetzt NI 614001.		Kegel sw 21 M12 x 1,5/H17	€ 67,60
			ASC; ASS; CUC; Huf 2.4; Huf 3.4; Huf 3.5; SE1C1; SE1C2; SE2C1; SE2C2; SE1S; SE2S; TTC / OE: VDD0 S180052048Z	

Stahl
RDKS

		F3, FDN, J3, JD, N3, NDN	09/02-10/11	Interstar
	Transporter		163351	9495
	1,9 dCi (60 kW)/2,2 dCi (66 kW)/2,5 dCi (73/84 kW)		195/65R16	RE 616003
	2,2 dCi (66 kW)/2,5 dCi (73/84 kW)/3,0 dCi (100 kW) (Auch 225/65R16 möglich)		205/75R16	6 J x16 H2 5x130x89 ET 66
	FZG-Schein beachten: Je nach Ausführung unterschiedliche Reifengrößen zulässig.		215/65R16	€ 90,90
			Kugel sw 19 M14 x 1,5 x 30	



Stahl
RDKS

		F15	10/10-	Juke
	SUV		163442	8177
	1,2i (85 kW)/ 1,6i (69/86 kW)/ 1,5D (81 kW)		205/60R16	*NI 516004 6½ J x16 CH 5x114,3x66 ET 40
	Nicht zulässig für 1,6i (140/147 kW)!		Kegel sw 21 M12 x 1,25	€ 85,60
			ASC; ASS; CUC; CUS; Huf 2.4; Huf 3.4; Huf 3.5; SE1S; SE2S; TTC	







Stahl
RDKS

		F15	10/10-	Juke
	SUV		163443	7856
	1,2i (85 kW)/ 1,6i (69/86 kW)/ 1,5D (81 kW)		205/60R16	NI 516005 6½ JJ x16 CH 5x114,3x66 ET 40
	Nicht zulässig für 1,6i (140/147 kW)!		Kegel sw 21 M12 x 1,25	€ 85,60
			ASC; ASS; CUC; CUS; Huf 2.4; Huf 3.4; Huf 3.5; SE1C1; SE1C2; SE2C1; SE2C2; SE1S; SE2S; TTC	

Stahl
RDKS

		F15, F15LPG, F15M		Juke	
		lichtsilber-lackiert		Celsio CS 656 40 5 14	
		lichtsilber-lackiert / mattschwarz-lackiert		Tezzo TZ 656 40 5 14	
		Rad frei für Allrad 140 - 147 kW	ABE	205/60R16 ❄️	6½ J x16 H2
			ABE	215/60R16 ❄️	5 x 114,3
			ABE	225/55R16 ❄️	ET 40
CS	TZ	MK 018	Celsio: ASC; ASS; CUC; Huf 2.4; Huf 3.4; Huf 3.5; SE1C1; SE1C2; SE1S; TTC; TTS Tezzo: ASC; ASS; CUC; Huf 2.4; Huf 3.4; Huf 3.5; SE1C1; SE1C2; SE1S; TTC		



ALU
MAGMA
RDKS

Juke				F15, F15LPG, F15M				
MAGNA	Interio		IN 706 45 5 14		lichtsilber-lackiert / mattschwarz-lackiert			
	7 J x16 EH2+	205/60R16	☼	ABE				Rad frei für Allrad 140 - 147 KW
	5 x 114,3	215/60R16	☼	ABE				
	ET 45	225/55R16	☼	ABE				
RDKS	ASC; CUC; Huf 2.4; Huf 3.4; Huf 3.5; SE1C1; SE1S			MK 018		IN	IN	
Micra			04/03-02/11	K12				
Stahl	NI 514012	5820	143747	Schrägheck				
	5 J x14 H2	165/70R14		1,0i (48 kW) / 1,2i (48/59 kW)				
	4x100x60							
	ET 45							
RDKS	€ 62,30	Kegel sw 19 M12 x 1,5 x 25						
Micra				K12				
MAGNA	Celsio		CS 554 35 4 00		lichtsilber-lackiert			
	5½ J x14 H2	165/70R14	☼	ABE				
	4 x 100							
	ET 35							
RDKS	ASC; ASS; Huf 2.4; Huf 3.4; SE1C1; SE1C2; SE1S; TTC; TTS			MK 216		CS		
Micra / Micra CC			04/03-02/11	K12				
Stahl	NI 515007	8305	154643	Schrägheck, Cabrio				
	5½ J x15 H2	175/60R15		1,0i (48 kW) / 1,2i (48/59 kW), 1,4i (65 kW)				
	4x100x60	175/65R15		1,5 dCi (48/60 kW)				
	ET 50							
RDKS	€ 72,40	Kegel sw 19 M12 x 1,5 x 25		FZG-Schein beachten: Je nach Ausführung unterschiedliche Reifengrößen zulässig.				
Micra / Micra CC				K12				
MAGNA	Seismo		SO 605 38 4 00		lichtsilber-lackiert / mattschwarz-lackiert			
	Interio		IN 605 38 4 00		lichtsilber-lackiert / mattschwarz-lackiert			
	6 J x15 H2	175/60R15						
	4 x 100	175/65R15						
RDKS	Seismo: ASC; ASS; Huf 2.4; Huf 3.4; SE1C1; SE1C2; SE1S; TTC Interio: ASC; ASS; CUS; Huf 2.4; Huf 3.4; SE1C1; SE1C2; SE1S; TTC; TTS			MK 216		SO		IN

		K13	03/11-	Micra		
	Schrägheck	143748	7030	NI 514013		
	1,2i (59/72 kW)	165/70R14		5½ J x14 H2 4x100x60 ET 45		
	1,2i (72 kW): Je nach Ausführung nur 15 Zoll!	Kegel sw 21 M12 x 1,25		€ 62,90		
		ASC; ASS; CUC; Huf 2.4; Huf 3.4; SE1C1; SE2C2; SE1S; SE2S; TTC / OE: Pacific				RDKS

		K13	Micra		
		lichtsilber-lackiert	Celsio	CS 554 35 4 00	
	Serienbereifung beachten	ABE	165/70R14	5½ J x14 H2 4 x 100 ET 35	
	MK 015	ASC; ASS; Huf 2.4; Huf 3.4; SE1C1; SE1C2; SE1S; TTC; TTS			

		K13	03/11-	Micra		
	Schrägheck	154643	8305	NI 515007		
	1,2i (59/72 kW)	175/60R15		5½ J x15 H2 4x100x60 ET 50		
		Kegel sw 21 M12 x 1,25		€ 72,40		
		ASC; ASS; CUC; SE1C1; SE1C2; SE1S / OE: Pacific				RDKS

		K13	Micra		
		lichtsilber-lackiert / mattschwarz-lackiert		Interio	IN 605 38 4 00
			ABE	165/65R15	6 J x15 H2 4 x 100 ET 38
			TÜV	175/60R15	
IN	IN	MK 015		ASC; ASS; CUS; Huf 2.4; Huf 3.4; SE1C1; SE1C2; SE1S; TTC; TTS	

		E11	03/06-09/13	Note		
	Mini-Van	154645	6775	NI 515008		
	1,4i (65 kW)/ 1,6i (81 kW)/ 1,5 dCi (50/63 kW)	175/65R15 185/65R15		5½ J x15 H2 4x100x60 ET 45		
		Kegel sw 19 M12 x 1,5 x 25		€ 72,40		
						RDKS





Note I			E11	
MAGNA	Seismo	SO 605 38 4 00	lichtsilber-lackiert / matschwarz-lackiert	
	Interio	IN 605 38 4 00	lichtsilber-lackiert / matschwarz-lackiert	
	6 J x15 H2	175/65R15 *	ABE	
	4 x 100	185/65R15 *	ABE	
ET 38				
RDKS	Seismo: ASC; ASS; Huf 2.4; Huf 3.4; SE1C1; SE1C2; SE1S; TTC Interio: ASC; ASS; CUS; Huf 2.4; Huf 3.4; SE1C1; SE1C2; SE1S; TTC; TTS		MK 216	
			SO	IN

Note II		10/13-	E12	
Stahl	NI 515010	7340	154646	Mini-Van
	5½ J x15 H2	185/65R15		1,2i (59/72 kW)/ 1,5 dCi (66 kW)
	4x100x60			
	ET 40			
	€ 72,40	Kegel sw 21 M12 x 1,25		
RDKS	ASC; ASS; CUC; CUS; Huf 2.4; Huf 3.4; Huf 3.5; SE1C1; SE1C2; SE2C2; SE1S; SE2S; TTC / OE: VDO S180052048Z			

Note II			E12	
MAGNA	Interio	IN 605 38 4 00	lichtsilber-lackiert / matschwarz-lackiert	
	6 J x15 H2	185/65R15 *	ABE	
	4 x 100			
	ET 38			
RDKS	ASC; ASS; CUS; Huf 2.4; Huf 3.4; SE1C1; SE1C2; SE1S; TTC; TTS		MK 015	
			IN	IN

NV200		11/09-10/14	M20M, M20N	
Stahl	*NI 614001	6375	143749	Kombi, Kasten
	5½ J x14 CH	175/70R14C		1,6i (81 kW)/ 1,5D (63/66/81 kW)
	4x114,3x66			
	ET 45			
	€ 67,60	Kegel sw 21 M12 x 1,25		
RDKS	ASC; ASS; CUC; Huf 2.4; Huf 3.4; Huf 3.5; SE1C1; SE1C2; SE2C1; SE2C2; SE1S; SE2S; TTC / OE: VDO S180052048Z			

NV200		11/14-	M20M, M20N	
Stahl	NI 614002		143750	Kombi, Kasten
	5½ J x14 CH	175/70R14C		1,6i (81 kW)/ 1,5D (63/66/81 kW)
	4x114,3x66			
	ET 45			
	€ 67,60	Kegel sw 21 M12 x 1,25		
RDKS	ASC; ASS; CUC; Huf 2.4; Huf 3.4; Huf 3.5; SE1C1; SE1C2; SE2C1; SE2C2; SE1S; SE2S; TTC / OE: VDO S180052048Z			
			Für TPMS modifiziertes Rad. Ersetzt NI 614001.	

		M1, M2, M6, M7	11/11-	NV400	
	Transporter	163346	8733	RE 616015	
	dCi 125 (92 kW)/ dCi 150 (107 kW)	195/75R16C		5½ J x16 H2 6x200x142,1 ET 110	
Rad für Zwillingbereifung! Auch Vorderachse. Rad für 3,5t / 4,5t mit Heckantrieb!				€ 118,60	
RDKS					
		M1, M2, M9	11/11-	NV400	
	Transporter	163348	9133	RE 616012	
	dCi 100 (74 kW) => 2,8t-3,3t Ecoline	215/65R16C		6½ J x16 H2	
	dCi 100 (74 kW)/ dCi 125 (92 kW) => 3,3t	215/65R16C		5x130x89	
	dCi 100 (74 kW)/ dCi 125 (92 kW) => 3,5t	225/65R16C		ET 66	
Rad für Singlebereifung! Rad für 2,8t-3,3t / 3,5t mit Frontantrieb! Je nach Ausführung unterschiedliche Reifenabmessungen vorgeschrieben!		Kegel sw 19 M14 x 1,5 x 30		€ 87,70	
		Huf 3.5; SE1C1; SE2C1; SE1S; SE2S / OE: VDO		RDKS	
		M1, M2, M9	11/11-	NV400	
	Transporter	163349	9367	RE 616013	
	dCi 125 (92 kW)/ dCi 150 (107 kW)	235/65R16C		7 J x16 H2 5x130x89 ET 66	
	Rad für Singlebereifung! Rad für 3,5t mit Heckantrieb! Je nach Ausführung unterschiedliche Reifenabmessungen vorgeschrieben!	Kegel sw 19 M14 x 1,5 x 30		€ 88,20	
		Huf 3.5; SE1C1; SE2C1; SE1S; SE2S / OE: VDO		RDKS	
		HF	07/09-10/13	Pixo	
	City-Wagon	143767	5400	SU 514008	
	1,0 (50 kW)	155/65R14		4½ J x14 CH 4x100x54 ET 45	
		Kegel sw 21 M12 x 1,25		€ 58,70	
RDKS					
		F4, J4	01/03-08/14	Primastar	
	Transporter	163353	9506	RE 616008	
	2,0i-16V (88 kW)/1,9 dCi (60/74 kW)/2,5 dCi (99 kW)	195/65R16		6 J x16 H2	
		205/65R16		5x118x71	
		215/65R16		ET 50	
FZG-Schein beachten: Je nach Ausführung unterschiedliche Reifenabmessungen vorgeschrieben.		Kugel sw 19 M14 x 1,5 x 30		€ 87,70	
RDKS					

Primastar			09/14-	J4, 4	
Stahl	RE 616016	7503	163428	Combi, Kasten	
	6 J x16 H2	205/65R16C		1,6 dCi (66/84/88/103 kW)	
	5x114,3x66	215/65R16C			
	ET 50				
	€ 87,70			Typ J4: ab EGBE e2*98/14*0271*35 Typ 4: ab EGBE e2*2007/46*0037*11 Typ 4 84 kW: Einige Ausführungen auch 195/65R16C	
RDKS	ASC; ASS; CUC; Huf 2.4; Huf 3.4; SE1C1; SE1C2; SE1S; TTC; TTS / OE: VDO				

Primera			03/02-01/07	P12	
Stahl	*NI 516001	9735	163440	Stufenheck, Traveller	
	6½ JJ x16 CH	205/60R16		1,6i (80 kW)/ 1,8i (85 kW)/ 2,0i (103 kW)/	
	5x114,3x66			1,9 dCi (88 kW)/ 2,2 Di (93 kW)/ 2,2 dCi (102 kW)	
	ET 40				
	€ 85,60	Kegel sw 21 M12 x 1,25/H16			
RDKS					

Pulsar			10/14-	C13	
Stahl	NI 516005	7856	163443	Schrägheck	
	6½ JJ x16 CH	195/60R16		1,2i (85 kW)/ 1,5 dCi (81 kW)/ 1,6i (140 kW)	
	5x114,3x66	205/55R16			
	ET 40				
	€ 85,60				
RDKS	ASC; ASS; CUC; CUS; Huf 2.4; Huf 3.4; Huf 3.5; SE1C1; SE1C2; SE2C2; SE1S; SE2S; TTC / OE: VDO S180052048Z				

Qashqai			02/07-01/14	J10	
Stahl	NI 516003	7855	163441	SUV	
	6½ J x16 CH	215/65R16		1,6i (84/86 kW)/ 2,0i (104 kW)/	
	5x114,3x66			1,5 dCi (78/81 kW)/ 1,6 dCi (96 kW)/ 2,0 dCi (110 kW)/ 4x4	
	ET 40				
	€ 85,60	Kegel sw 21 M12 x 1,25/H16		Nicht zulässig für Qashqai+2!	
RDKS					

Qashqai I / Qashqai +2				J10			
NISSAN MAXIMA	Celsio	CS 656 40 5 14		lichtsilber-lackiert			
	Tezzo	TZ 656 40 5 14		lichtsilber-lackiert / mattschwarz-lackiert			
	6½ J x16 H2	215/65R16	*	ABE			Bremsanlage beachten
	5 x 114,3	225/60R16	*	ABE			
ET 40	235/60R16		ABE				
RDKS	Celsio: ASC; ASS; CUC; Huf 2.4; Huf 3.4; Huf 3.5; SE1C1; SE1C2; SE1S; TTC; TTS Tezzo: ASC; ASS; CUC; Huf 2.4; Huf 3.4; Huf 3.5; SE1C1; SE1C2; SE1S; TTC			MK 018	CS	TZ	

		J10	Qashqai I / Qashqai +2		
		lichtsilber-lackiert / mattschwarz-lackiert		Tezzo	TZ 757 40 5 14
		Bremsanlage beachten	ABE	215/60R17 ❄	7½ J x17 H2 5 x 114,3 ET 40
	ABE	225/55R17			
	ABE	235/55R17			
TZ	TZ	MK 018	ASC; ASS; CUC; Huf 2.4; Huf 3.4; Huf 3.5; SE1C1; SE1C2; SE1S		



KRONPRINZ
MAGMA

RDKS

		J11	02/14-	Qashqai II	
	SUV	163443	7856	NI 516005	
	1,2 DIG-T (85 kW) / 1,6 DIG-T (120 kW) / 1,5 dCi (81/96 kW) / 1,6 dCi (96 kW) / 4x4	215/65R16		6½ JJ x16 CH 5x114,3x66 ET 40	
		Kegel sw 17 M12 x 1,5 x 26		€ 85,60	
		ASC; ASS; CUC; CUS; Huf 2.4; Huf 3.4; Huf 3.5; SE1C1; SE1C2; SE2C2; SE1S; SE2S; TTC / OE: VDO S180052048Z			



Stahl

RDKS

		J11	Qashqai II		
		lichtsilber-lackiert / mattschwarz-lackiert		Tezzo	TZ 656 40 5 14
			ABE	215/65R16	6½ J x16 H2 5 x 114,3 ET 40
	ABE	225/60R16			
TZ	TZ	MK 217	ASC; ASS; CUC; Huf 2.4; Huf 3.4; Huf 3.5; SE1C1; SE1C2; SE1S; TTC / OE: VDO S180052048Z		

KRONPRINZ
MAGMA

RDKS

		J11	Qashqai II		
		lichtsilber-lackiert / mattschwarz-lackiert		Tezzo	TZ 757 40 5 14
			ABE	215/55R17 ❄	7½ J x17 H2 5 x 114,3 ET 40
	ABE	215/60R17			
TZ	TZ	MK 217	ASC; ASS; CUC; Huf 2.4; Huf 3.4; Huf 3.5; SE1C1; SE1C2; SE1S / OE: VDO S180052048Z		



KRONPRINZ
MAGMA

RDKS

		C11	01/08-03/11	Tiida	
	Schräg-/ Stufenheck	154644	7730	*NI 515009	
	1,6i (81 kW) / 1,8i (93 kW) / 1,5 dCi (78 kW)	185/65R15 195/65R15		5½ JJ x15 CH 4x114,3x66 ET 40	
		Kegel sw 21 M12 x 1,25		€ 72,40	



Stahl

RDKS

X-Trail				T31	
KRONPRINZ MAGNA	Interio		IN 807 45 5 14	lichtsilber-lackiert / mattschwarz-lackiert	
	8 J x17 EH2+	215/60R17	ABE		
	5 x 114,3	225/55R17	ABE		
	ET 45	235/55R17	ABE		
RDKS	ASC; CUC; Huf 3.5; SE1C1; SE15		MK 018	IN	
X-Trail				T32	
KRONPRINZ MAGNA	Celsio		CS 808 38 5 14	lichtsilber-lackiert	
	8 J x18 EH2+	225/60R18	ABE		
	5 x 114,3				
	ET 38				
RDKS	ASC; ASS; CUC; Huf 2.4; Huf 3.4; Huf 3.5; SE1C1; SE1C2; SE15; TTC / OE: VDO S180052048Z		MK 018	CS	

OPEL

Adam / Adam Rocks			02/13-	S-D	
Renner	OP 514021	6515	143626	Steilheck	
	5½ J x14 H2	175/70R14		1,0i (66 kW) / 1,2i (51 kW) / 1,4i (66/74 kW) / 1,4 LPG (74 kW)	
	4x100x56,5				
	ET 39				
RDKS	€ 51,30	Kegel sw 17 M12 x 1,5 x 22	Einige Ausführungen nur 15 Zoll. Nicht 1,0i (85 kW) / 1,4i (110 kW)		
Adam / Adam Rocks				S-D	
KRONPRINZ MAGNA	Celsio		CS 554 35 4 00	lichtsilber-lackiert	
	5½ J x14 H2	175/70R14	☼	ABE	
	4 x 100	185/70R14	☼	ABE	
	ET 35	205/60R14	☼	ABE	
RDKS	ASC; ASS; Huf 2.4; Huf 3.4; SE1C1; SE1C2; SE15; TTS		MK 210	CS	

		S-D	Adam / Adam Rocks		
		lichtsilber-lackiert / mattschwarz-lackiert		Interio	IN 604 38 4 00
			ABE	175/70R14 ☼	6 J x14 H2 4 x 100 ET 38
			ABE	185/70R14 ☼	
			ABE	205/60R14 ☼	
IN	IN	MK 210	ASC; ASS; Huf 2.4; Huf 3.4; SE1C1; SE1C2; SE1S; TTC; TTS / OE: Schrader 3062		



MAGMA

RDKS

		S-D	02/13-	Adam / Adam Rocks	
	Steilheck 1,0i (66 kW) / 1,2i (51 kW) / 1,4i (66/74 kW) / 1,4 LPG (74 kW)	155001	6445	OP 515024	
		185/60R15 M+S		6 J x15 H2	
		185/65R15		4x100x56,5 ET 39	
Einige Ausführungen nur 16 Zoll LM. Nicht 1,4 i (110 kW)		Kegel sw 17 M12 x 1,5 x 22		€ 66,00	
		ASC; CUC; Huf 2.4; Huf 3.4; SE1C1; SE1C2; SE2C1; SE2C2; SE1S; SE2S; TTS / OE: Schrader 3062			

Renner

RDKS

		S-D	Adam / Adam Rocks		
		lichtsilber-lackiert / mattschwarz-lackiert		Interio	IN 605 38 4 00
			ABE	185/60R15 ☼	6 J x15 H2 4 x 100 ET 38
			ABE	185/65R15 ☼	
			ABE	195/60R15 ☼	
IN	IN	MK 210	ASC; ASS; CUS; Huf 2.4; Huf 3.4; SE1C1; SE1C2; SE1S; TTC; TTS / OE: Schrader 3062		

MAGMA

RDKS

		H00	10/03-03/08	Agila	
	Mini-Van 1,0i (44 kW) / 1,2i (55 kW) / 1,3 CDTi (51 kW)	143625	4920	SU 514005	
		155/65R14		4½ J x14 CH	
		165/60R14		4x100x54 ET 45	
Nur ab EGBE: e1*98/14*0141*08 155/65R14 nicht für 1,3 CDTi (51 kW) zulässig!		Kegel sw 21 M12 x 1,25/H16		€ 57,50	

Stahl

RDKS

		H-B	04/08-	Agila	
	Steilheck 1,0i (48 kW) / 1,2i (63 kW) / 1,3 CDTi (55 kW)	143756	5155	SU 514006	
		165/70R14		5 J x14 CH	
				4x100x54 ET 45	
		Kegel sw 17 M12 x 1,5 x 22		€ 59,70	

Stahl

RDKS

Agila		04/08-	H-B	
Stahl	SU 515003	7380	154653	Steilheck
	5½ J x15 CH	185/60R15		1,0i (48 kW)/ 1,2i (63 kW)/ 1,3 CDTi (55 kW)
	4x100x54			
	ET 50			
RDKS		€ 69,20	Kegel sw 17 M12 x 1,5 x 22	

Ampera		01/12-	D1J01	
Renner	OP 516014	9327	163334	Fließheck
	6½ J x16 H2	205/60R16 M+S		1,4 Hybrid (63/111 kW)
	5x115x70,3			
	ET 41			
RDKS		€ 81,40	Kegel sw 19 M12 x 1,5	
ASC; ASS; CUC; Huf 2.4; Huf 3.4; Huf 3.5; SE1C1; SE1C2; SE2C1; SE2C2; SE1S; SE2S; TTC; TTS / OE: Schrader 3026				

Antara		10/06-	L-A	
Stahl	OP 516011	7885	163336	SUV
	6½ J x16 H2	215/70R16		2,4i (103 kW)/ 2,0 CDTi (110 kW)/ 2,2 CDTi (135 kW)/ 3,2 V6 (167 kW)
	5x115x70,2			
	ET 46			
RDKS		€ 108,30	Kegel sw 19 M12 x 1,5	Baugleich mit Chevrolet Captiva.
ASC; ASS; CUC; CUS; Huf 3.5; SE1S; SE2S / OE: Schrader 3049				

Antara			L-A		
MAGNA	Celsio	CS 656 40 5 15	lichtsilber-lackiert		
	Tezzo	TZ 656 40 5 15	lichtsilber-lackiert / mattschwarz-lackiert		
	6½ J x16 H2	215/70R16 M+S ❄	ABE		
	5 x 115	225/70R16 ❄	ABE		
RDKS		ET 40	235/65R16	ABE	
Celsio: ASC; ASS; CUC; Huf 2.4; Huf 3.4; Huf 3.5; SE1C1; SE1C2; SE1S; TTC; TTS / OE: Schrader 3049			MK 048	CS	TZ
Tezzo: ASC; ASS; CUC; Huf 2.4; Huf 3.4; Huf 3.5; SE1C1; SE1C2; SE1S; TTC / OE: Schrader 3049					



Astra-F		09/92-02/98	Astra-F, -F-CC, T92, -F-Caravan	
Stahl	*OP 514002	6785	143623	Schräg-/ Stufenheck, Caravan
	5½ J x14 H2	175/65R14		1,4i/1,6i (55kW)/1,6i-16V/1,8i/
	4x100x56,5			
	ET 49	175/65R14 M+S		
RDKS		€ 55,00	Kegel sw 17 M12 x 1,5 x 22	GSi 2,0i/GSi 2,0i-16V
				

Astra-F-Cabrio, T92Conv		05/93-05/00	Astra-F	
	Cabrio	143623	6785	*OP 514002
	1,6i (55 kW)/1,8i-16V/2,0i	185/60R14		5½ J x14 H2
		175/65R14 M+S		4x100x56,5
				ET 49
				€ 55,00
RDKS				
T98, T98/NB, T98/Kombi, G-LFW		03/98-02/04	Astra-G	
	Schräg-/Stufenheck, Caravan	153102	8390	*OP 515008
	1,2i(48/55 kW)/1,6i(55/63/74 kW)/1,8i(85/92 kW)/	195/60R15		6 J x15 H2
	2,0i(100 kW)/2,2i (108 kW)/			4x100x56,5
	1,7TD(55 kW)/1,7 DTI(55 kW)/			ET 49
	Wenn Fahrzeug 5-Loch Anschluss (speziell Caravan), dann OP 515016 verwenden!			€ 68,70
RDKS				
T98, T98/NB, T98/Kombi		01/99-02/04	Astra-G	
	Schräg-/Stufenheck, Caravan	154101	8060	OP 515016
	1,8i (85/92 kW)/2,0i (100 kW)/2,2i (108 kW)/	195/60R15		6 J x15 H2
	2,0DI (60 kW)/ 2,0 DTI (74 kW)			5x110x65
				ET 49
				€ 68,70
RDKS				
T98C		06/00-02/04	Astra-G	
	Coupé	154101	8060	OP 515016
	1,6i (74 kW)/1,8i (85/92 kW), 2,2i (108 kW)	195/60R15		6 J x15 H2
		185/65R15 M+S		5x110x65
				ET 49
	Bei Fahrzeugen mit 4-Loch Anschluss OP 515008 verwenden!			€ 68,70
RDKS				
T98C		03/01-02/04	Astra-G	
	Cabrio	154101	8060	OP 515016
	1,6i (74 kW)/1,8i (92 kW), 2,2i (108 kW)	195/60R15		6 J x15 H2
		185/65R15 M+S		5x110x65
				ET 49
	Bei Fahrzeugen mit 4-Loch Anschluss OP 515008 verwenden!			€ 68,70
RDKS				



Astra-H			03/04-10/09	A-H, A-H/C, A-H/SW	
Stahl	OP 515022	8365	154901	Schrägheck, Caravan, GTC	
	6½ J x15 H2	185/65R15		1,4i (66 kW) / 1,6i (77 kW)	
	4x100x56,5	195/60R15			
	ET 35	195/65R15			
RDKS		€ 68,70		Kegel sw 17 M12 x 1,5 x 22	Wichtig: Nur für Fahrzeuge mit 4-Loch Anschluss! Bei 5-Loch OP 515027 verwenden. FZG-Schein beachten: Je nach Ausführung unterschiedliche Reifenabmessungen zulässig. 1,6i (77 kW) mit IDS Plus- bzw. Sportfahrwerk hat 5-Loch Anschluss.

Astra-H			A-H, A-H/C, A-H/SW			
MAGNA	Celsio	CS 655 35 4 00	lichtsilber-lackiert			
	6½ J x15 H2	185/65R15	☼	ABE		4-Loch Ausführung
	4 x 100	195/60R15	☼	ABE		
	ET 35	195/65R15	☼	ABE		
RDKS		ASC; ASS; CUC; Huf 2.4; Huf 3.4; Huf 3.5; SE1C1; SE1C2; SE1S; TTC; TTS		MK 210	CS	

Astra-H			03/04-10/09	A-H, A-H/C, A-H/SW	
Renner	OP 515027	9245	154404	Schrägheck, Caravan, GTC	
	6½ J x15 H2	185/65R15		1,6i (85 kW) / 1,8i (92 kW) / 1,3 CDTI (66 kW) /	
	5x110x65	195/60R15		1,7 CDTI (59/74/81 kW)	
	ET 35	195/65R15			
RDKS		€ 68,20		Kegel sw 17 M12 x 1,5 x 22	Ersetzt OP 515020. FZG-Schein beachten: Je nach Ausführung unterschiedliche Reifenabmessungen zulässig.

Astra-H			A-H, A-H/C, A-H/SW				
MAGNA	Seismo	SO 705 38 5 10	lichtsilber-lackiert / mattschwarz-lackiert				
	7 J x15 H2	185/65R15	☼	ABE			5-Loch Ausführung
	5 x 110	195/60R15	☼	ABE			
	ET 38	195/65R15	☼	ABE			
RDKS		ASC; ASS; CUC; Huf 2.4; Huf 3.4; SE1C1; SE1C2; SE1S; TTC		MK 202	SO	SO	

Astra-H			03/04-10/09	A-H, A-H/C, A-H/SW	
Renner	OP 516007	9045	164701	Schrägheck, Caravan, GTC	
	6½ J x16 H2	205/55R16		1,6i (85 kW) / 1,8i (92 kW) / 2,0i Turbo (125/147 kW) /	
	5x110x65			1,3 CDTI (66 kW) / 1,7 CDTI (59/74/81 kW) /	
	ET 37			1,9 CDTI (74/88/110 kW)	
RDKS		€ 81,40		Kegel sw 17 M12 x 1,5 x 22	Wichtig: Nur für Fahrzeuge mit 5-Loch Anschluss! Bei 4-Loch OP 516008 verwenden. FZG-Schein beachten, bei einigen Ausführungen nur 15 Zoll zulässig.

		A-H, A-H/C, A-H/SW	Astra-H / Astra TwinTop		
		lichtsilber-lackiert / mattschwarz-lackiert		Interio	IN 706 35 5 10
		5-Loch Ausführung	ABE	205/55R16 ❄	7 J x16 EH2+ 5 x 110 ET 35
IN	IN	MK 202	ASC; CUC; Huf 2.4; Huf 3.4; Huf 3.5; SE1C1; SE1S		

KRONPRINZ
MAGMA

RDKS

		A-H/C	04/06-10/09	Astra TwinTop	
	Cabrio 1,6i (77 kW)/ 1,6T (132 kW)/ 1,8i (103 kW)/ 2,0T (125/147 kW)/ 1,9 CDTi (110 kW)	164701	9045	OP 516007	Renner
		205/55R16		6½ J x16 H2 5x110x65 ET 37	
		Kegel sw 17 M12 x 1,5 x 22		€ 81,40	RDKS



Renner

RDKS

		P-J, P-J/SW, P-J/V	11/09-09/15	Astra-J / Sports Tourer	
	Schräg-/ Stufenheck, Sports Tourer 1,4i (64/74 kW)/ 1,4T (88/103 kW)/ 1,4 LPG (103 kW)/ 1,6i (85 kW)/ 1,3 CDTi (70 kW)	163333	9247	OP 516013	Renner
		205/55R16		6½ J x16 H2	
		205/60R16		5x105x56,6 ET 39	
FZG-Schein beachten: Je nach Ausführung unterschiedliche Reifenabmessungen zulässig. Für Fahrzeuge mit Anschluss: 5x105x56,6.		Kegel sw 19 M12 x 1,5		€ 81,40	RDKS
		ASC; ASS; CUC; Huf 2.4; Huf 3.4; Huf 3.5; SE1C1; SE1C2; SE2C1; SE2C2; SE1S; SE2S; TTC; TTS / OE: Schrader 3033			

Renner

RDKS

		P-J, P-J/SW, P-J/V	Astra-J / Sports Tourer		
		lichtsilber-lackiert		Celsio	CS 656 38 5 05
		lichtsilber-lackiert / mattschwarz-lackiert		Tezzo	TZ 656 38 5 05
CS	TZ	Lochkreis beachten 5 x 105	ABE	205/60R16 ❄	6½ J x16 H2
		Bei 215/60R16 Auflagen / Serienbereifung beachten!	ABE	215/60R16 ❄	5 x 105 ET 38
MK 036		Celsio: ASC; ASS; CUC; Huf 2.4; Huf 3.4; Huf 3.5; SE1C1; SE1C2; SE1S; TTC; TTS / OE: Schrader 3033 Tezzo: ASC; ASS; CUC; Huf 2.4; Huf 3.4; Huf 3.5; SE1C1; SE1C2; SE1S; TTC / OE: Schrader 3033			



KRONPRINZ
MAGMA

RDKS

		P-J, P-J/SW, P-J/V, P-J/SW/V	11/09-09/15	Astra-J / Sports Tourer	
	Schräg-/ Stufenheck, Sports Tourer 1,7 CDTi (81/92 kW) 1,6 CDTi (81/100/110 kW)/ 1,7 CDTi (81/92/96 kW)/ 2,0 CDTi (118/121 kW)/ 1,6T (125/132 kW)	163334	9327	OP 516014	Renner
		205/55R16		6½ J x16 H2	
		205/60R16		5x115x70,3 ET 41	
FZG-Schein beachten: Je nach Ausführung unterschiedliche Reifenabmessungen zulässig. Einige Ausführungen auch 205/65R16 zulässig. Für Fahrzeuge mit Anschluss: 5x115x70,3. Nicht 2,0 CDTi (143 kW).		Kegel sw 19 M12 x 1,5		€ 81,40	RDKS
		ASC; ASS; CUC; Huf 2.4; Huf 3.4; Huf 3.5; SE1C1; SE1C2; SE2C1; SE2C2; SE1S; SE2S; TTC; TTS / OE: Schrader 3033			

Renner

RDKS

Astra-J / Sports Tourer				P-J, P-J/SW, P-J/N, P-J/SW/V	
MAGNA	Celsio		CS 656 40 5 15	lichtsilber-lackiert	
	Tezzo		TZ 656 40 5 15	lichtsilber-lackiert / matschwarz-lackiert	
	6½ J x16 H2	205/60R16	⊗	ABE	Lochkreis beachten 5 x 115
	5 x 115	215/60R16	⊗	ABE	
ET 40					
RDKS	Celsio: ASC; ASS; CUC; Huf 2.4; Huf 3.4; Huf 3.5; SE1C1; SE1C2; SE15; TTC; TTS / OE: Schrader 3033 Tezzo: ASC; ASS; CUC; Huf 2.4; Huf 3.4; Huf 3.5; SE1C1; SE1C2; SE15; TTC / OE: Schrader 3033			MK 048	 CS  TZ

Astra-J GTC / Cascada				P-J, P-J/SW	
MAGNA	Celsio		CS 707 38 5 15	lichtsilber-lackiert	
	7 J x17 EH2+		225/55R17	⊗	ABE
	5 x 115		235/50R17	⊗	ABE
	ET 38				
RDKS	ASC; ASS; CUC; Huf 2.4; Huf 3.4; Huf 3.5; SE1C1; SE1C2; SE15; TTC / OE: Schrader 3033			MK 048	 CS

Astra-K		10/15-	B-K
Stahl	OP 515029	6365	154639
	6 J x15 H2	195/65R15	
	5x105x56,6		
	ET 37		
	€ 66,00		
RDKS	ASC; ASS; CUC; CUS; Huf 2.4; Huf 3.4; Huf 3.5; SE2S		Schrägheck 1,0i (77 kW) / 1,4i (74/92/110 kW) / 1,6 CDTi (70 kW) Einige Ausführungen nur 16 Zoll!! Sports Tourer 2016-

Radabbildung
in
Vorbereitung

Astra-K		10/15-	B-K
Stahl	OP 516017	7035	163408
	6½ J x16 H2	205/55R16	
	5x105x56,6		
	ET 41		
	€ 78,20		
RDKS	ASC; ASS; CUC; CUS; Huf 2.4; Huf 3.4; Huf 3.5; SE2S		Schrägheck 1,0i (77 kW) / 1,4i (74/92/110 kW) / 1,6 CDTi (70/81/110 kW) Sports Tourer 2016-

Radabbildung
in
Vorbereitung

Astra-K		B-K
MAGNA	in Vorbereitung	
RDKS		

Radabbildung
in
Vorbereitung

		Calibra-A	09/92-05/97	Calibra	
	Coupé	143623	6785	*OP 514002	Stahl
	2,0i/2,0i-16V/2,0i 4x4	195/60R14 175/70R14 M+S		5½ J x14 H2 4x100x56,5 ET 49	
	14"-Räder nicht für Turbo!		Kegel sw 17 M12 x 1,5 x 22	€ 55,00	
RDKS					
		Combo-C, Combo-C-Van	11/01-03/12	Combo-C	
	Combi, Kasten	143621	6480	OP 614001	Stahl
	1,4i (66 kW)/ 1,6i (64 kW)/ 1,3 CDTi (51 kW)/ 1,7 DI (48 kW)/ 1,7 Dti (55 kW)/ 1,6 CNG (69/ 71 kW)	175/65R14 175/70R14		5½ J x14 H2 4x100x56,5 ET 49	
	Je nach Ausführung unterschiedliche Reifenabmessungen vorgeschrieben.		Kegel sw 17 M12 x 1,5 x 22	€ 62,50	
RDKS					
		Combo-C, Combo-C-Van	11/01-03/12	Combo-C	
	Combi, Kasten	154535	8375	OP 615001	Stahl
	1,4i (66 kW)/ 1,6i (64 kW)/ 1,3 CDTi (51 kW)/ 1,7 DI (48 kW)/ 1,7 Dti (55 kW)/ 1,6 CNG (69/ 71 kW)	185/55R15 M+S 185/60R15		6 J x15 H2 4x100x56,5 ET 49	
	Für Fahrzeuge mit erhöhter Radlast. Je nach Ausführung unterschiedliche Reifenabmessungen vorgeschrieben. Bei Combo-C: Nur zulässig ab EGBE e1*98/14*0179*02. Bei Combo-C-Van: Nur zulässig ab ABE-Nr.: K886 Nachtrag 5.		Kegel sw 17 M12 x 1,5 x 22	€ 73,40	
RDKS					
		Combo-C, Combo-C-Van	11/01-03/12	Combo-C	
	Combi, Kasten	154101	8060	OP 515016	Stahl
	1,7 CDTi (74 kW)	185/55R15 M+S 185/60R15		6 J x15 H2 5x110x65 ET 49	
	Für Fahrzeuge mit 5-Loch Anschluss. Je nach Ausführung unterschiedliche Reifenabmessungen vorgeschrieben.		Kegel sw 17 M12 x 1,5 x 22	€ 68,70	
RDKS					
		Combo-D-Van	04/12-10/14	Combo-D	
	Mini-Van	154595	7395	FL 615006	Stahl
	1,3 CDTi (66 kW)/ 1,6 CDTi (66/77 kW)	185/65R15 195/65R15		6 J x15 H2 5x98x58 ET 39	
			Kegel sw 17 M12 x 1,25 x 22	€ 72,40	
OE: Schrader 3016 RDKS					

Combo-D		04/12-10/14	Combo-D-Van		
Stahl	*FL 516002	8048	163383		Mini-Van
	6 J x16 H2	195/60R16C			1,4i (70/88 kW) / 1,3 CDTi (55/66 kW) / 1,6 CDTi (66/77 kW) / 2,0 CDTi (99 kW) / 1,4 CNG (88 kW)
	5x98x58				
	ET 36,5				
€ 79,80		Kegel sw 17 M12 x 1,25 x 22			
RDKS	SE25				

Combo-D		04/12-10/14	Combo-D-Van		
Stahl	FL 616007	8049	163395		Mini-Van
	6 J x16 H2	195/60R16C			1,4i (70/88 kW) / 1,3 CDTi (55/66 kW) / 1,6 CDTi (66/77 kW) / 2,0 CDTi (99 kW) / 1,4 CNG (88 kW)
	5x98x58				
	ET 36,5				
€ 79,80		Kegel sw 17 M12 x 1,25 x 22		TPMS modifiziertes Rad.	
RDKS	ASC ; ASS ; CUC ; Huf 2.4 ; Huf 3.4 ; Huf 3.5 ; SE1C1 ; SE1C2 ; SE2C1 ; SE2C2 ; SE1S ; SE2S ; TTC / OE: Schrader 3016				



Combo-D		04/12-10/14	Combo-D		
Stahl	FL 615006	7395	154595		Kasten
	6 J x15 H2	185/65R15			1,6 CDTi (66/77 kW)
	5x98x58	195/65R15			
	ET 39				
€ 72,40		Kegel sw 17 M12 x 1,25 x 22			
RDKS	OE: Schrader 3016				

Combo-D		04/12-10/14	Combo-D		
Stahl	*FL 516002	8048	163383		Kasten
	6 J x16 H2	195/60R16C			1,4i (70 kW) / 1,3 CDTi (55/66 kW) / 1,6 CDTi (66/77 kW) / 2,0 CDTi (99 kW) / 1,6 CNG (88 kW)
	5x98x58				
	ET 36,5				
€ 79,80		Kegel sw 17 M12 x 1,25 x 22			
RDKS	SE25				



Combo-D		04/12-10/14	Combo-D		
Stahl	FL 616007	8049	163395		Kasten
	6 J x16 H2	195/60R16C			1,4i (70 kW) / 1,3 CDTi (55/66 kW) / 1,6 CDTi (66/77 kW) / 2,0 CDTi (99 kW) / 1,6 CNG (88 kW)
	5x98x58				
	ET 36,5				
€ 79,80				TPMS modifiziertes Rad.	
RDKS	ASC ; ASS ; CUC ; Huf 2.4 ; Huf 3.4 ; Huf 3.5 ; SE1C1 ; SE1C2 ; SE2C1 ; SE2C2 ; SE1S ; SE2S ; TTC / OE: Schrader 3016				



		Corsa-B-CC	03/93-05/97	Corsa-B	
	Schrägheck	143623	6785	*OP 514002	Stahl
	1,0i/1,2i,1,4i/1,4i-16V (66 kW)/1,5D/1,5TD/1,7TD	165/60R14		5½ J x14 H2	
	1,6 Gsi	165/65R14 M+S		4x100x56,5	Stahl
				ET 49	
	Corsa-Räder nicht für Opel Combo zulässig!		Kegel sw 17 M12 x 1,5 x 22	€ 55,00	
RDKS					
		Corsa-C	10/00-08/06	Corsa-C	
	Schrägheck	133801	4010	OP 513013	Stahl
	1,0-12V (44 kW) / 1,2-16V (55 kW)	155/80R13		5 J x13 H2	
				4x100x56,5	Stahl
				ET 43	
			Kegel sw 17 M12 x 1,5 x 22	€ 46,50	
RDKS					
		Corsa-C	10/00-08/06	Corsa-C	
	Schrägheck	144001	6790	OP 514018	Stahl
	1,0-12V (44 kW) / 1,2-16V (55 kW) / 1,4-16V (66 kW) / 1,8-16V (92 kW) / 1,3 CDTi (51 kW) / 1,7 DTI (48/55 kW)	175/65R14		5½ J x14 H2	
				4x100x56,5	Stahl
				ET 49	
			Kegel sw 17 M12 x 1,5 x 22	€ 55,00	
RDKS					
		Corsa-C	10/00-08/06	Corsa-C	
	Schrägheck	154101	8060	OP 515016	Stahl
	1,7 CDTi (74 kW)	185/55R15		6 J x15 H2	
				5x110x65	Stahl
				ET 49	
	Für Fahrzeuge mit 5-Loch Anschluss.		Kegel sw 17 M12 x 1,5 x 22	€ 68,70	
RDKS					
		GMB, S-D, S-D/V, S-D/Van	09/06-12/14	Corsa-D	
	Schrägheck	143626	6515	OP 514021	Renner
	1,0i (44 kW) / 1,2i (51/59/63 kW) / 1,4i (66/74 kW) / 1,3 CDTi (55/70 kW) / 1,2 LPG (61/63kW)	185/70R14		5½ J x14 H2	
				4x100x56,5	Renner
				ET 39	
	Einige Ausführungen auch 175/70R14. Einige Ausführungen nur 15 Zoll.		Kegel sw 17 M12 x 1,5 x 22	€ 51,30	
RDKS					
ASS; Huf 3.5; SE1S; SE2S					

Corsa-D				GMIB, S-D, S-D/V, S-D/VAN		
MAGNA	Celsio		CS 554 35 4 00		lichtsilber-lackiert	
	5½ J x14 H2		185/70R14	☼		ABE
	4 x 100		195/65R14	☼		ABE
	ET 35		205/65R14	☼		ABE
RDKS	ASC; ASS; Huf 2.4; Huf 3.4; SE1C1; SE1C2; SE1S; TTC; TTS				MK 210	CS 

Corsa-D				GMIB, S-D, S-D/V, S-D/VAN		
MAGNA	Interio		IN 604 38 4 00		lichtsilber-lackiert / mattschwarz-lackiert	
	6 J x14 H2		185/70R14	☼		ABE
	4 x 100		195/65R14	☼		ABE
	ET 38		205/65R14	☼		ABE
RDKS	ASC; ASS; Huf 2.4; Huf 3.4; SE1C1; SE1C2; SE1S; TTC; TTS				MK 210	IN  

Corsa-D			09/06-12/14	GMIB, S-D, S-D/V, S-D/Van	
Renner	OP 515024	6445	155001	Schrägheck	
	6 J x15 H2	185/60R15		1,0i (44 kW) / 1,2i (51/59/63 kW) / 1,4i (66/74/88 kW) /	
	4x100x56,5	185/65R15		1,3 CDTi (55/66/70 kW) / 1,2 LPG (61/63kW)	
	ET 39	195/60R15			
RDKS	€ 66,00	Kegel sw 17 M12 x 1,5 x 22		Für Fahrzeuge mit 4-Loch Anschluss. FZG-Schein beachten. Je nach Ausführung unterschiedliche Reifengrößen zulässig.	

Corsa-D				GMIB, S-D, S-D/V, S-D/VAN		
MAGNA	Interio		IN 605 38 4 00		lichtsilber-lackiert / mattschwarz-lackiert	
	6 J x15 H2		185/60R15	☼		ABE
	4 x 100		185/65R15	☼		ABE
	ET 38		195/60R15	☼		ABE
RDKS	ASC; ASS; CUC; Huf 2.4; Huf 3.4; SE1C1; SE1C2; SE1S; TTC; TTS				MK 210	IN  

Corsa-D				GMIB, S-D, S-D/V, S-D/VAN			
MAGNA	Celsio		CS 655 35 4 00		lichtsilber-lackiert		
	Tezzo		TZ 655 35 4 00			lichtsilber-lackiert / mattschwarz-lackiert	
	6½ J x15 H2		185/60R15	☼			ABE
	4 x 100		185/65R15	☼			ABE
ET 35		195/60R15	☼	ABE			
RDKS	Celsio: ASC; ASS; CUC; Huf 2.4; Huf 3.4; SE1C1; SE1C2; SE1S; TTC; TTS Tezzo: ASC; ASS; CUC; Huf 2.4; Huf 3.4; SE1C1; SE1C2; SE1S; TTC				MK 210	CS  	

GMIB, S-D, S-D/V, S-D/Van		09/06-12/14	Corsa-D	
	Schrägheck	163332	9507	OP 516009
	1,0i (44 kW)/ 1,2i (51/59/63 kW)/ 1,4i (66/74/88 kW)/ 1,3 CDTi (55/66/70 kW)/ 1,2 LPG (61/63kW)	195/55R16		6 J x16 H2 4x100x56,5 ET 40
	Für Fahrzeuge mit 4-Loch Anschluss.	Kegel sw 17 M12 x 1,5 x 22		€ 78,20
		ASC; ASS; CUC; CUS; Huf 2.4; Huf 3.4; Huf 3.5; SE2C2; SE1S; SE2S; TTC; TTS		RDKS

S-D		09/06-12/14	Corsa-D	
	Schrägheck	163331	9543	OP 516010
	1,7 CDTi (92/96 kW) GSI (110 kW)/ OPC (141 kW)	195/55R16 195/55R16 M+S 205/50R16 M+S		6 J x16 H2 5x110x65 ET 40
	Für Fahrzeuge mit 5-Loch Anschluss.	Kegel sw 17 M12 x 1,5 x 22		€ 78,20
		ASS; CUS; Huf 3.5; SE1S; SE2S		RDKS

S-D		01/15-	Corsa-E	
	Schrägheck	143626	6515	OP 514021
	1,2i (51 kW)/ 1,4i (66 kW)/ 1,4 LPG (66 kW)	175/70R14 185/70R14		5½ J x14 H2 4x100x56,5 ET 39
	Für Fahrzeuge mit 4-Loch Anschluss. Einige Ausführungen nur 15 Zoll. FZG-Schein beachten. Je nach Ausführung unterschiedliche Reifengrößen zulässig.			€ 51,30
		ASS; Huf 3.5; SE1S; SE2S		RDKS

S-D		01/15-	Corsa-E	
	Schrägheck	155001	6445	OP 515024
	1,0T (66/85 kW)/ 1,2i (51 kW)/ 1,4i (66 kW)/ 1,4T (74/110 kW)/ 1,3 CDTi (55/70 kW)/ 1,4 LPG (66 kW)	185/65R15		6 J x15 H2 4x100x56,5 ET 39
	Für Fahrzeuge mit 4-Loch Anschluss.			€ 66,00
		ASS; CUC; Huf 2.4; Huf 3.4; Huf 3.5; SE1C1; SE1C2; SE2C1; SE2C2; SE1S; SE2S; TTS		RDKS

S-D		Corsa-E	
Radabbildung in Vorbereitung			
			in Vorbereitung
		RDKS	

Corsa-E		01/15-	S-D	
Stahl	OP 516009	9507	163332	Schrägheck
	6 J x16 H2	195/55R16		1,0T (66/85 kW) / 1,2i (51 kW) / 1,4i (66 kW) / 1,4T (74/110 kW) / 1,3 CDTi (55/70 kW) / 1,4 LPG (66 kW)
	4x100x56,5 ET 40			
	€ 78,20			Für Fahrzeuge mit 4-Loch Anschluss.
RDKS	ASC; ASS; CUC; CUS; Huf 2.4; Huf 3.4; Huf 3.5; SE2C2; SE15; SE25; TTC; TTS			

Corsa-E		01/15-	S-D	
Stahl	OP 516010	9543	163331	Schrägheck
	6 J x16 H2	195/55R16		1,4T (110 kW)
	5x110x65 ET 40			
	€ 78,20			Für Fahrzeuge mit 5-Loch Anschluss. OPC 152 kW nur 17 Zoll.
RDKS	ASS; CUS; Huf 3.5; SE15; SE25			



Insignia		10/08-	OG-A, GMIK	
Renner	OP 516012	9623	164703	Stufenheck
	6½ J x16 H2	205/60R16 M+S		1,4i (103 kW) / 1,6i (85 kW) / 1,8i (103 kW) / 2,0 CDTi (81 kW) / 2,0 CDTi (88/96/103 kW) / 1,4 LPG (103 kW)
	5x120x67 ET 41	215/60R16		2,0 CDTi (118/125 kW)
	€ 81,40	Kegel sw 21 M14 x 1,5		FZG-Schein beachten. Je nach Ausführung unterschiedliche Reifenabmessungen vorgeschrieben. Max. 1265 kg Achslast!
RDKS	ASC; ASS; CUC; Huf 2.4; Huf 3.4; Huf 3.5; SE1C1; SE1C2; SE2C1; SE2C2; SE15; SE25; TTC; TTS / OE: Schrader 3033			

Insignia		10/08-	OG-A, GMIK	
Renner	OP 517003		17520201	Stufenheck
	7 J x17 H2	215/55R17		1,4i (103 kW) / 1,6i (85 kW) / 1,8i (103 kW) / 1,6 Turbo (125/132 kW) / 2,0 Turbo (162/184 kW) / 2,8 V6 (191 kW) / 1,4 LPG (103 kW) / 2,0 CDTi (81/88/96/103/118/120/125/140/143/184 kW) / 4x4
	5x120x67 ET 41	225/50R17		
	€ 93,70	225/55R17		FZG-Schein beachten. Je nach Ausführung unterschiedliche Reifenabmessungen vorgeschrieben. Ersetzt OP 517002.
RDKS	ASC; ASS; CUC; CUS; Huf 2.4; Huf 3.4; Huf 3.5; SE1C1; SE1C2; SE2C1; SE2C2; SE15; SE25; TTC; TTS / OE: Schrader 3033			

Insignia Sports Tourer		03/09-	OG-A, GMIK	
Renner	OP 516012	9623	164703	SportsTourer
	6½ J x16 H2	205/60R16 M+S		1,4i (103 kW) / 1,6i (85 kW) / 1,8i (103 kW) / 1,4 LPG (103 kW)
	5x120x67 ET 41	215/60R16		
	€ 81,40	Kegel sw 21 M14 x 1,5		FZG-Schein beachten. Je nach Ausführung unterschiedliche Reifenabmessungen vorgeschrieben. Max. 1265 kg Achslast!
RDKS	ASC; ASS; CUC; Huf 2.4; Huf 3.4; Huf 3.5; SE1C1; SE1C2; SE2C1; SE2C2; SE15; SE25; TTC; TTS / OE: Schrader 3033			

OG-A, OG-A/V, GMIK		03/09-	Insignia Sports Tourer	
	SportsTourer	17520201		OP 517003
	1,4i (103 kW) / 1,6i (85 kW) / 1,8i (103 kW) / 1,6 Turbo (125/132 kW) / 2,0 Turbo (162 kW) / 2,8 V6 (191 kW) / 2,0 CDTi (81/88/96/103/118/120/125 kW) / 2,0 Bi-Turbo (140/143/184 kW) / 4x4	215/55R17		7 J x17 H2
	FZG-Schein beachten. Je nach Ausführung unterschiedliche Reifenabmessungen vorgeschrieben. Ersetzt OP 517002.	225/50R17		5x120x67
		225/55R17		ET 41
	Kegel sw 21 M14 x 1,5			€ 93,70
		ASC; ASS; CUC; CUS; Huf 2.4; Huf 3.4; Huf 3.5; SE1C1; SE1C2; SE2C1; SE2C2; SE1S; SE2S; TTC; TTS / OE: Schrader 3033		RDKS

Renner

OG-A, OG-A/V, GMIK		Insignia / Insignia Sports Tourer		
		lichtsilber-lackiert / mattschwarz-lackiert		Tezzo
				TZ 807 35 5 20
		ABE	215/55R17 M+S ❄	8 J x17 H2
		ABE	225/50R17 ❄	
ABE	225/55R17	ET 35		
TZ	MK 071	ASC; ASS; CUC; Huf 2.4; Huf 3.4; Huf 3.5; SE1C1; SE1C2; SE1S; TTC / OE: Schrader 3033		RDKS

MAGMA

OG-A, OG-A/V, GMIK		Insignia / Insignia Sports Tourer		
		lichtsilber-lackiert		Celsio
				CS 808 35 5 20
		ABE	225/45R18	8 J x18 EH2+
		ABE	235/45R18	
ABE	245/45R18	ET 35		
CS	MK 071	ASC; ASS; CUC; Huf 2.4; Huf 3.4; Huf 3.5; SE1C1; SE1C2; SE1S; TTC / OE: Schrader 3033		RDKS

MAGMA

D-A		06/15-	Karl	
Radabbildung in Vorbereitung	Steilheck	143613	3015	OP 514022
	1,0i (55 kW)	165/65R14		5 J x14 H2
				4x100x56,5
				ET 38
				€ 57,50
				RDKS

Stahl



X01MONOCAB		03/03-04/10	Meriva-A	
	Mini-Van	143628	6235	*OP 514020
	1,4i (66 kW) / 1,6i (64 kW)	175/70R14		5½ J x14 H2
				4x100x56,5
				ET 43
	Kegel sw 17 M12 x 1,5 x 22			€ 56,20
				RDKS

Stahl



Meriva-A			03/03-04/10	X01 MONOCAB	
Stahl	OP 515021	6435	154532	Mini-Van	
	6 J x15 H2	185/60R15		1,4i (66 kW) / 1,6i (64/74 kW) / 1,8i (92 kW) / 1,7 DTI (55 kW)	
	4x100x56,5 ET 43				
	€ 65,00	Kegel sw 17 M12 x 1,5 x 22			
RDKS					

Meriva-A			10/03-04/10	X01 MONOCAB	
Stahl	OP 515017	8010	154102	Mini-Van	
	6 J x15 H2	185/60R15		1,7 CDTi (74 kW)	
	5x110x65 ET 43				
	€ 66,60	Kegel sw 17 M12 x 1,5 x 22		Für Fahrzeuge mit 5-Loch Anschluss.	
RDKS					



Meriva-B			05/10-	S-D Monocab B	
Renner	OP 515027	9245	154404	Mini-Van	
	6½ J x15 H2	195/65R15		1,4i (74 kW) / 1,3 CDTi (55/70 kW) / 1,4 ecoFlex (88 kW)	
	5x110x65 ET 35				
	€ 68,20	Kegel sw 17 M12 x 1,5 x 22		Nicht zulässig für 1,7 CDTi / 1,4i (103 kW)	
RDKS ASC; ASS; CUC; Huf 2.4; Huf 3.4; Huf 3.5; SE1C1; SE2C1; SE2C2; SE1S; SE2S					

Meriva-B			S-D Monocab B				
MAGNA	Seismo	SO 705 38 5 10	lichtsilber-lackiert / mattschwarz-lackiert				
	7 J x15 H2	195/65R15	⊛	ABE			
	5 x 110	205/60R15	⊛	ABE			
	ET 38	215/60R15		ABE			
RDKS ASC; ASS; CUC; Huf 2.4; Huf 3.4; SE1C1; SE1C2; SE1S; TTC / OE-Schrader 3062						MK 202	

Meriva-B			05/10-	S-D Monocab B, S-D Monocab B/V	
Renner	OP 516007	9045	164701	Mini-Van	
	6½ J x16 H2	205/55R16		1,4i (74/103 kW) / 1,3 CDTi (55/70 kW) / 1,7 CDTi (74/81/96 kW) / 1,4 ecoFlex (88 kW)	
	5x110x65 ET 37				
	€ 81,40	Kegel sw 17 M12 x 1,5 x 22		Einige Ausführungen auch 195/60R16 C.	
RDKS ASC; ASS; CUC; Huf 2.4; Huf 3.4; Huf 3.5; SE1C1; SE1C2; SE2C1; SE2C2; SE1S; SE2S; TTC					

		S-D Monocab B, S-D Monocab B/V	Meriva-B	
	IN	lichtsilber-lackiert / mattschwarz-lackiert	Interio	
			IN 706 35 5 10	
	IN	MK 202	ABE	195/60R16
			ABE	205/55R16 ❄
			7 J x16 EH2+	MAGMA
			5 x 110	
			ET 35	
			ASC; CUC; Huf 2.4; Huf 3.4; Huf 3.5; SE1C1; SE1S	RDKS

		J-A	11/12-	Mokka	
	SUV 1,4T (103 kW)/1,6i (85 kW)/1,7 CDTi (96 kW)/1,4 LPG (103 kW)/AWD 1,4T/1,6i/1,6 CDTi (81/100 kW)/ 1,7 CDTi (96 kW)/1,4 LPG/AWD Je nach Ausführung unterschiedliche Bereifung zulässig!	163338	9272	OP 516015	
			195/70R16	6½ J x16 H2	
			215/65R16	5x105x56,6	
			205/70R16	ET 38	
			Kegel sw 19 M12 x 1,5	€ 81,90	
			ASC; ASS; CUC; CUS; Huf 2.4; Huf 3.4; Huf 3.5; SE1C1; SE1S; SE2S; TTC; TTS / OE: Schrader 3049		
					RDKS

		J-A	Mokka		
	CS	lichtsilber-lackiert	Celsio		CS 656 38 5 05
			TZ		TZ 656 38 5 05
	TZ	lichtsilber-lackiert / mattschwarz-lackiert	ABE	205/70R16	6½ J x16 H2
			ABE	215/65R16	5 x 105
			ABE	225/60R16 ❄	ET 38
			Celsio: ASC; ASS; CUC; Huf 2.4; Huf 3.4; Huf 3.5; SE1C1; SE1C2; SE1S; TTC; TTS / OE: Schrader 3049		
			Tezzo: ASC; ASS; CUC; Huf 2.4; Huf 3.4; Huf 3.5; SE1C1; SE1C2; SE1S; TTC / OE: Schrader 3049		
					RDKS

		F9, H9, J9, U9, J9/OAG	08/00-03/10	Movano	
	Transporter 1,9 CDTi/2,2 CDTi/2,5 CDTi/2,5D/2,8DTi 2,2 CDTi/2,5 CDTi/2,5D/2,8DTi/3,0 CDTi RE 616003 nur in Verbindung mit 4 Bremscheiben ! FZG-Schein beachten: Unterschiedliche Reifen zulässig. Bei einigen Ausführungen auch 205/75R16 möglich.	163351	9495	RE 616003	
			195/65R16	6 J x16 H2	
			215/65R16	5x130x89	
			225/65R16	ET 66	
			Kegel sw 19 M14 x 1,5 x 30	€ 90,90	
					RDKS

		MR	04/10-	Movano	
	Transporter 2,3 CDTi (92/107 kW) Rad für Zwillingsbereifung! Auch Vorderachse. Rad für 4,5t mit Heckantrieb!	163346	8733	RE 616015	
			195/75R16C	5½ J x16 H2	
				6x200x142,1	
				ET 110	
				€ 118,60	
					RDKS

Movano		04/10-	MR, MS	
Stahl	RE 616012	9133	163348	Transporter
	6½ J x16 H2	215/65R16C		2,3 CDTi (74/92 kW) => 2,8t / 3,3t
	5x130x89	225/65R16C		2,3 CDTi (74/92 kW) => 3,5t
	ET 66			
	€ 87,70	Kegel sw 19 M14 x 1,5 x 30		Rad für Singlebereifung! Rad für 2,8t / 3,3t / 3,5t mit Frontantrieb! Je nach Ausführung sind unterschiedliche Reifenabmessungen vorgeschrieben!
RDKS	Huf 3.5 ; SE1C1 ; SE2C1 ; SE1S ; SE2S / OE: Schrader 3041			



Movano		04/10-	MR, MS	
Stahl	RE 616013	9367	163349	Transporter
	7 J x16 H2	235/65R16C		2,3 CDTi (92/107 kW)
	5x130x89			
	ET 66			
	€ 88,20	Kegel sw 19 M14 x 1,5 x 30		Rad für Singlebereifung! Rad für 3,5t mit Heckantrieb!
RDKS	Huf 3.5 ; SE1C1 ; SE2C1 ; SE1S ; SE2S / OE: Schrader 3041			



Signum		05/03-06/08	VECTRA(SIGNUM), Z-C/S	
Renner	OP 515027	9245	154404	Schrägheck
	6½ J x15 H2	195/65R15 M+S		1,8i (90 kW)/ 2,2i (114 kW)/ 1,9 CDTi (88/110 kW)/ 2,0 DTI (74 kW)/ 2,2 DTI (92 kW)
	5x110x65			
	ET 35			
	€ 68,20	Kegel sw 17 M12 x 1,5 x 22		FZG-Schein beachten, 15 Zoll nur zulässig ab EGBE e1*2001/116*0214*03!
RDKS				





Signum		05/03-06/08	VECTRA/CAR, VECTRA, VECTRA(SIGNUM), Z-C/S	
Stahl	SA 516002	9455	163330	Schrägheck
	6½ J x16 H2	215/55R16		1,8i (90 kW)/ 2,0T (129 kW)/ 2,2i (114 kW)/ 3,2 V6 (155 kW)/ 1,9 CDTi (88/110 kW)/ 2,0 DTI (74 kW)/ 2,2 DTI (92 kW)/ 3,0 CDTi (130 kW)
	5x110x65			
	ET 41			
	€ 81,40	Kegel sw 17 M12 x 1,5 x 22		OP 516006 darf nicht verbaut werden. Ab EGBE e1*2001/116*0214*03 bei einigen Ausführungen auch 205/55R16 zulässig.
RDKS				





Tigra		10/94-12/00	S93-Coupé	
Stahl	*OP 514002	6785	143623	Coupé
	5½ J x14 H2	175/65R14		1,4i-16V (66 kW)
	4x100x56,5	175/65R14 M+S		1,6i-16V
	ET 49			
	€ 55,00	Kegel sw 17 M12 x 1,5 x 22		
RDKS				





		X-C/ROADSTER	09/04-12/09	Tigra TwinTop	
	Cabrio	154532	6435	OP 515021	Stahl
	1,4i (66 kW)/ 1,8i (92 kW)/ 1,3 CDTi (51 kW)	185/55R15		6 J x15 H2 4x100x56,5 ET 43	
		Kegel sw 17 M12 x 1,5 x 22		€ 65,00	RDKS

		X-C/ROADSTER	09/04-12/09	Tigra TwinTop	
	Cabrio	154901	8365	OP 515022	Stahl
	1,4i (66 kW)/ 1,8i (92 kW)/ 1,3 CDTi (51 kW)	185/60R15		6½ J x15 H2 4x100x56,5 ET 35	
	Nur für Sommerbereifung zulässig!	Kegel sw 17 M12 x 1,5 x 22		€ 68,70	RDKS

		X-C/ROADSTER	Tigra TwinTop			
		lichtsilber-lackiert / mattschwarz-lackiert	Seismo	SO 605 38 4 00		
		lichtsilber-lackiert / mattschwarz-lackiert	Interio	IN 605 38 4 00		
			ABE	185/55R15 ❄	6 J x15 H2 4 x 100 ET 38	MAGNAMA
			ABE	185/60R15		
			Seismo: ASC ; ASS ; Huf 2.4 ; Huf 3.4 ; SE1C1 ; SE1C2 ; SE1S ; TTC Interio: ASC ; ASS ; CUS ; Huf 2.4 ; Huf 3.4 ; SE1C1 ; SE1C2 ; SE1S ; TTC ; TTS			
SO	IN	MK 210				

		Vectra-A, Vectra-A-CC	09/92-09/95	Vectra-A	
	Schräg-/ Stufenheck	143623	6785	*OP 514002	Stahl
	1,6i/1,6Si/1,8i/2,0i/2,0i 4x4/1,7D/1,7TD	175/70R14		5½ J x14 H2	
	GT-16V	175/70R14 M+S		4x100x56,5 ET 49	
		Kegel sw 17 M12 x 1,5 x 22		€ 55,00	RDKS

		VECTRA/SW, Z-C/SW	08/03-10/08	Vectra-C	
	Caravan	154404	9245	OP 515027	Renner
	1,8i (90 kW)/ 1,9 CDTi (88/110 kW)/ 2,0 DTi (74 kW)/ 2,2 DTi (92 kW)	195/65R15		6½ J x15 H2 5x110x65	
	2,2i (114 kW)	195/65R15 M+S		ET 35	
	Rad-/Reifenkombinationen und Auflagen im FZG-Schein beachten!	Kegel sw 17 M12 x 1,5 x 22		€ 68,20	RDKS

Vectra-C			08/03-10/08	VECTRA/SW, Z-C/SW	
Stahl	SA 516002	9455	163330	Caravan	
	6½ J x16 H2	205/55R16		1,8i (90 kW)/2,0T (129 kW)/2,2i (114 kW)/	
	5x110x65	215/55R16		3,2 V6 (155 kW)/1,9 CDTi (88/110 kW)/2,0 DTi (74 kW)/2,2 DTi (92 kW)/3,0 V6 CDTi (130 kW)	
	ET 41				
RDKS	€ 81,40	Kegel sw 17 M12 x 1,5 x 22		OP 516006 darf nicht verbaut werden. Rad-/Reifenkombinationen und Auflagen im FZG-Schein beachten! 2,0T, 3,2 V6 und 3,0 V6 CDTi nur 215/55R16 zulässig.	

Vectra-C / Vectra-C GTS			04/02-10/08	VECTRA/LIM, Z-C	
Renner	OP 515027	9245	154404	Schräg-/Stufenheck	
	6½ J x15 H2	195/65R15		1,6i (74 kW) / 1,8i (90 kW) / 1,9 CDTi (88/110 kW) /	
	5x110x65			2,0 DTi (74 kW) / 2,2 DTi (92 kW)	
	ET 35	195/65R15 M+S		2,0T (129 kW) / 2,2i (114 kW)	
RDKS	€ 68,20	Kegel sw 17 M12 x 1,5 x 22		Rad-/Reifenkombinationen und Auflagen im FZG-Schein beachten!	

Vectra-C / Vectra-C GTS			04/02-10/08	VECTRA/LIM, Z-C	
Stahl	SA 516002	9455	163330	Schräg-/Stufenheck	
	6½ J x16 H2	205/55R16		1,6i (74 kW)/1,8i (90 kW)/ 2,0T (129 kW)/2,2i (114 kW)/3,2 V6 (155 kW)/1,9 CDTi (88/110 kW)/2,0 DTi (74 kW)/2,2 DTi (92 kW)/3,0 V6 CDTi (130 kW)	
	5x110x65	215/55R16			
	ET 41				
RDKS	€ 81,40	Kegel sw 17 M12 x 1,5 x 22		OP 516006 darf bei 3,2 V6 und 3,0 V6 CDTi nicht verbaut werden. Rad-/Reifenkombinationen und Auflagen im FZG-Schein beachten! 3,2 V6 und 3,0 V6 CDTi nur 215/55R16 zulässig!	



Vivaro			07/01-08/14	E7, F7	
Stahl	RE 616008	9506	163353	Transporter	
	6 J x16 H2	195/65R16		2,0i 16V (88 kW)/1,9 DI (59 kW)/1,9 DTi (74 kW)/	
	5x118x71	205/65R16		2,0 CDTi (66/84 kW) / 2,5 DTi (99 kW) / 2,5 CDTi (107 kW)	
	ET 50	215/65R16			
RDKS	€ 87,70	Kegel sw 19 M14 x 1,5 x 30		RE 616008 auch für Renault Trafic ab 07/01-, FZG-Schein beachten, unterschiedliche Reifen zulässig. 2,5 CDTi (107 kW) nicht 195/65R16!	

Vivaro Life			07/01-08/14	X83	
Stahl	RE 616008	9506	163353	Van	
	6 J x16 H2	195/65R16		2,0i 16V (88 kW)/1,9 DI (60 kW)/1,9 DTi (74 kW) / 2,0 CDTi (66/84 kW)	
	5x118x71	205/65R16		2,5 DTi (99 kW) / 2,5 CDTi (107 kW)	
	ET 50	215/65R16			
RDKS	€ 87,70	Kegel sw 19 M14 x 1,5 x 30		RE 616008 auch für Renault Trafic ab 07/01-, FZG-Schein beachten, unterschiedliche Reifen zulässig. Bei einigen Ausführungen auch 195/75R16 möglich.	



		F7, X83	09/14-	Vivaro II	
	Combi, Kasten	163428	7503	RE 616016	
	1,6 CDTi (66/85 kW)/ 1,6 BiTurbo CDTi (88/103 kW)	205/65R16C		6 J x16 H2	
		215/65R16C		5x114,3x66	
	Typ F7: ab EGBE e1*2007/46*0575*12			ET 50	
	Typ X83: ab EGBE e1*98/14*0170*30			€ 87,70	
		ASC; ASS; CUC; Huf 2.4; Huf 3.4; SE1C1; SE1C2; SE1S; TTC; TTS / OE: Schrader 3041		RDKS	

		T98/Monocab	03/99-06/05	Zafira-A	
	Van	154102	8010	OP 515017	
	1,6i (55/74 kW)/1,8i (85/92 kW)/2,0i (100 kW)/2,2i/2,0 DI (60 kW)/2,0 DTI (74 kW)	195/65R15		6 J x15 H2	
				5x110x65	
				ET 43	
		Kegel sw 17 M12 x 1,5 x 22		€ 66,60	
				RDKS	

		A-H/Monocab	07/05-09/11	Zafira-B	
	Van	154404	9245	OP 515027	
	1,6i (77/85 kW)/ 1,8i (103 kW)	195/65R15		6½ J x15 H2	
				5x110x65	
				ET 35	
		Kegel sw 17 M12 x 1,5 x 22		€ 68,20	
				RDKS	

		A-H Monocab		Zafira-B		
		lichtsilber-lackiert / mattschwarz-lackiert		Seismo	SO 705 38 5 10	
				ABE	195/65R15 ❄	7 J x15 H2
				ABE	205/60R15 ❄	
						ET 38
SO	SO	MK 202		ASC; ASS; CUC; Huf 2.4; Huf 3.4; SE1C1; SE1C2; SE1S; TTC		RDKS



		A-H/Monocab, A-H/Monocab/ V, A-H/Monocab-CNG		07/05-09/11	Zafira-B	
	Van	164701	9045	OP 516007		
	1,6i (77/85 kW)/ 1,8i (103 kW)/ 2,2i (110 kW)/ 2,0T (147 kW)/ 1,7 CDTi (81/92 kW)/ 1,9 CDTi (74/88/110 kW)/ 1,6 CNG (69/110 kW)	205/55R16		6½ J x16 H2		
				5x110x65		
				ET 37		
		Kegel sw 17 M12 x 1,5 x 22		€ 81,40		
				RDKS		

Zafira-B			A-H Monocab, A-H Monocab/Van, A-H Monocab/CNG	
MAGNA	Interio	IN 706 35 5 10	lichtsilber-lackiert / mattschwarz-lackiert	
	7 J x16 H2	205/55R16 * ABE		
	5 x 110	215/50R16 * ABE		
	ET 35			
RDKS	ASC; CUC; Huf2.4; Huf3.4; Huf3.5; SE1C1; SE1S		MK 202	IN

Zafira Family (Zafira-B)		10/11-	A-H/Monocab	
Renner	OP 515027	9245	154404	Van
	6½ J x15 H2	195/65R15		1,6i (85 kW)
	5x110x65			
	ET 35			
€ 68,20	Kegel sw 17 M12 x 1,5 x 22		Baureihe wird parallel zum neuen Zafira-C (Typ: P-J/SW) weitergebaut.	
RDKS	ASC; ASS; CUC; Huf2.4; Huf3.4; Huf3.5; SE1C1; SE2C1; SE2C2; SE1S; SE2S			

Zafira Family (Zafira-B)		10/11-	A-H/Monocab, A-H/Monocab/ V, A-H/Monocab-CNG	
Renner	OP 516007	9045	164701	Van
	6½ J x16 H2	205/55R16		1,6i (85 kW)/ 1,7 CDTi (81/92 kW)/ 1,6 CNG (110 kW)
	5x110x65			
	ET 37			
€ 81,40	Kegel sw 17 M12 x 1,5 x 22		Baureihe wird parallel zum neuen Zafira-C (Typ: P-J/SW) weitergebaut.	
RDKS	ASC; ASS; CUC; Huf2.4; Huf3.4; Huf3.5; SE1C1; SE1C2; SE2C1; SE2C2; SE1S; SE2S; TTC			

Zafira Tourer (Zafira-C)		10/11-	P-J/SW, P-J/SW/V	
Renner	OP 516014	9327	163334	Van
	6½ J x16 H2	215/60R16		1,8i (85 kW)/ 1,4T (88/103 kW)/ 1,6 CDTi (100 kW)/ 2,0 CDTi (81/96)/ 1,6 CNG (110 kW)/ 1,4 LPG (103 kW)
	5x115x70,3			
	ET 41			
€ 81,40	Kegel sw 19 M12 x 1,5		Nicht zulässig für 1,6 SIDI (125 kW)/ 2,0 CDTi (121/143 kW)	
RDKS	ASC; ASS; CUC; Huf2.4; Huf3.4; Huf3.5; SE1C1; SE1C2; SE2C1; SE2C2; SE1S; SE2S; TTC; TTS / OE-Schrader 3033			

Zafira Tourer (Zafira-C)			P-J/SW, P-J/SW/V	
MAGNA	Celsio	CS 656 40 5 15	lichtsilber-lackiert	
	Tezzo	TZ 656 40 5 15	lichtsilber-lackiert / mattschwarz-lackiert	
	6½ J x16 H2	215/60R16 * ABE		
	5 x 115	225/55R16 * ABE		
ET 40	235/55R16 * ABE			
RDKS	Celsio: ASC; ASS; CUC; Huf2.4; Huf3.4; Huf3.5; SE1C1; SE1C2; SE1S; TTC; TTS / OE-Schrader 3033 Tezzo: ASC; ASS; CUC; Huf2.4; Huf3.4; Huf3.5; SE1C1; SE1C2; SE1S; TTC / OE-Schrader 3033		MK 048	CS

		K	07/05-11/09	1007	
	Mini-Van	143657	6215	PS 514022	Stahl
	1,4 75 (55 kW)/ 1,4 HDi 70 (50 kW)	175/65R14		5½ J x14 H2 4x108x65 ET 24	
		Kegel sw 17 M12 x 1,25 x 26		€ 54,40	RDKS
		K	07/05-11/09	1007	
	Mini-Van	154556	8690	PS 515037	Stahl
	1,4 75 (55 kW)/ 1,6 110 (80 kW)/ 1,4 HDi 70 (50 kW)	185/60R15		6 J x15 H2 4x108x65 ET 27	
		Kegel sw 17 M12 x 1,25 x 26		€ 67,10	RDKS
		P	09/05-06/14	107	
	Schrägheck	143765	4940	TO 514017	Stahl
	1,0i (50 kW)	155/65R14		4½ J x14 H2 4x100x54 ET 39	
	TO 514017 auch für Citroën C1 / Toyota Aygo.	Kegel sw 17 M12 x 1,5 x 19		€ 58,10	RDKS
		P	07/14-	108	
	Schrägheck	143720	5770	TO 514021	Stahl
	1,0i (51 kW)/ 1,2i (60 kW)	165/65R14		4½ J x14 H2 4x100x54 ET 35	
				€ 58,10	RDKS
		P	07/14-	108	
	Schrägheck	154629	7510	TO 515019	Stahl
	1,0i (51 kW)/ 1,2i (60 kW)	165/60R15		4½ J x15 H2 4x100x54 ET 35	
	165/60R15 nur zulässig wenn werkseitig mit 15"-Bereifung ausgerüstet			€ 71,90	RDKS







206			10/98-03/09	2*HFV/HFZ/8HX/8HZ/KFW/KFX/KFU/NFZ/NFU/WJY/WJZ/RHY	
Stahl	PS 514021	5990	143651	Schrägheck	
	5½ J x14 CH	175/65R14		1,1i (44 kW)/ 1,4i (55/65 kW)/ 1,6i (65 kW)	
	4x108x65	185/65R14		1,4 HDi (50 kW)/ 1,9D (51 kW)/ 2,0 HDi (66 kW)	
	ET 34	185/65R14		1,6i-16V (80 kW)	
	€ 54,40	Kegel sw 19 M12 x 1,25 x 26		PS 514021 nicht für S16 (99 kW)!	
RDKS			FZG-Schein beachten: Je nach Ausführung unterschiedliche Radabmessungen zulässig, einige Ausführungen nur 15 Zoll.		



206			08/00-03/09	2 KFU, 2 NFU, 2 RFN, 2 RFK, 2 9HZ, 2 RHY	
Stahl	PS 515037	8690	154556	Schrägheck	
	6 J x15 H2	185/55R15		1,4i (65 kW)/ 1,6i (80 kW)/ 2,0i-16V (100 kW)	
	4x108x65	195/55R15		2,0 HDi (66 kW)	
	ET 27	195/55R15		1,6 HDi (80 kW)/ 2,0i-16V RC (130 kW)	
	€ 67,10	Kegel sw 19 M12 x 1,25 x 26		FZG-Schein beachten: Je nach Ausführung unterschiedliche Radabmessungen zulässig, einige Ausführungen nur 14 Zoll.	
RDKS					

206 CC			10/00-02/07	2NFU, 2RFN, 2 9HZ	
Stahl	PS 515037	8690	154556	Cabrio	
	6 J x15 H2	185/55R15		1,6i 16V (80 kW)/2,0i-16V (100 kW)	
	4x108x65	195/55R15			
	ET 27	195/55R15		1,6 HDi (80 kW)	
	€ 67,10	Kegel sw 19 M12 x 1,25 x 26			
RDKS					



206 SW			06/02-05/07	2 HFV, 2 KFW, 2 KFU, 2 NFU, 2 8HX, 2 8HZ, 2 RHY	
Stahl	PS 514021	5990	143651	Kombi	
	5½ J x14 CH	175/65R14		1,1i (44 kW)/ 1,4i (55 kW)/ 1,4i (65 kW)/	
	4x108x65			1,4 HDi (50 kW)	
	ET 34	185/65R14		1,4i (65 kW)/ 1,6i (80 kW)/ 2,0 HDi (66 kW)	
	€ 54,40	Kegel sw 19 M12 x 1,25 x 26		FZG-Schein beachten: Je nach Ausführung unterschiedliche Radabmessungen zulässig, einige Ausführungen nur 15 Zoll.	
RDKS					

206 SW			06/02-05/07	2 KFU, 2 NFU, 2 RFN, 2 9HZ, 2 RHY	
Stahl	PS 515037	8690	154556	Kombi	
	6 J x15 H2	195/55R15		1,4i (65 kW)/ 1,6i (80 kW)/ 2,0i-16V (100 kW)/	
	4x108x65			1,6 HDi (80 kW)/ 2,0 HDi (66 kW)	
	ET 27				
	€ 67,10	Kegel sw 19 M12 x 1,25 x 26		FZG-Schein beachten: Einige Ausführungen nur 14 Zoll.	
RDKS					



		2*...*	206 / 206+ / 206 CC / 206 SW			
 IN	 IN	lichtsilber-lackiert / mattschwarz-lackiert		Interio	IN 605 25 4 08	
		Bereifung 185/60R15 nur 206+!	ABE	185/55R15	6 J x15 H2 4 x 108 ET 25	
			ABE	185/60R15		
ABE	195/55R15					
MK 102		ASC; ASS; CUS; Huf 2.4; Huf 3.4; SE1C1; SE1C2; SE15; TTC; TTS			RDKS	
		2	04/09-12/12	206+		
	Schrägheck	143651	5990	PS 514021	Stahl RDKS	
	1,1i (44 kW) / 1,4i (55 kW) / 1,4 HDi (50 kW)	175/65R14		5½ J x14 CH 4x108x65 ET 34		
		Kegel sw 17 M12 x 1,25 x 26		€ 54,40		
		2	04/09-12/12	206+		
	Schrägheck	143657	6215	PS 514022	Stahl RDKS	
	1,1i (44 kW) / 1,4i (55 kW) / 1,4 HDi (50 kW)	175/65R14		5½ J x14 H2 4x108x65 ET 24		
		Kegel sw 17 M12 x 1,25 x 26		€ 54,40		
		2	04/09-12/12	206+		
	Schrägheck	154556	8690	PS 515037	Stahl RDKS	
	1,4i (55 kW) / 1,4 HDi (50 kW)	185/60R15		6 J x15 H2 4x108x65 ET 27		
		Kegel sw 17 M12 x 1,25 x 26		€ 67,10		
		W	06/06-	207 / 207 SW		
	Schrägheck, Kombi	154560	8055	PS 515045	Renner RDKS	
	1,4i (54 kW) / 1,4i 16V (65 kW) / 1,4 HDi (50 kW) / 1,6i 16V (80/82/88 kW) / 1,6 HDi (66/80 kW)	185/65R15		6 J x15 H2 4x108x65 ET 23		
	FZG-Papiere beachten. Bei einigen Ausführungen ist nur 16 Zoll zulässig.	Kegel sw 17 M12 x 1,25 x 26		€ 67,10		
		ASC; ASS; CUC; Huf 2.4; Huf 3.4; Huf 3.5; SE1C1; SE1C2; SE2C1; SE2C2; SE15; SE25; TTC / OE: Schrader 3002			RDKS	

207 / 207 SW				W			
MAGNA	Interio		IN 605 25 4 08	lichtsilber-lackiert / mattschwarz-lackiert			
	6 J x15 H2	185/65R15	ABE				
	4 x 108						
	ET 25						
RDKS	ASC; ASS; CUS; Huf 2.4; Huf 3.4; SE1C1; SE1C2; SE1S; TTC; TTS / OE: Schrader 3002			MK 102	IN	IN	



207 / 207 SW / 207 CC			06/06-	W		
Stahl	PS 516013	7845	163365	Schrägheck, Kombi, Cabrio		
	6 J x16 H2	195/55R16		1,4i (70 kW) / 1,6i 16V (80/82/88) /		
	4x108x65			1,6i 16V Turbo (110 kW) / 1,6i 16V RC (128 kW) /		
	ET 27			1,6 HDi (66/80 kW)		
	€ 77,10	Kegel sw 17 M12 x 1,25 x 26		FZG-Papiere beachten. Bei einigen Ausführungen ist nur 15 Zoll zulässig.		
RDKS	OE: Schrader 3002					

207 / 207 SW / 207 CC				W			
MAGNA	Celsio		CS 656 26 4 08	lichtsilber-lackiert			
	Tezzo		TZ 656 26 4 08	lichtsilber-lackiert / mattschwarz-lackiert			
	6½ J x16 H2	185/55R16	ABE				
	4 x 108	195/50R16	ABE				
	ET 26	195/55R16	ABE				
RDKS	Celsio: ASC; ASS; CUC; Huf 2.4; Huf 3.4; Huf 3.5; SE1C1; SE1C2; SE1S; TTC; TTS / OE: Schrader 3002 Tezzo: ASC; ASS; CUC; Huf 2.4; Huf 3.4; Huf 3.5; SE1C1; SE1C2; SE1S; TTC / OE: Schrader 3002			MK 102	CS	TZ	



208			04/12-	C		
Renner	PS 515045	8055	154560	Schrägheck		
	6 J x15 H2	185/65R15		1,0i (50 kW) / 1,2i (60 kW) / 1,4i (70 kW) / 1,6i (88 kW) /		
	4x108x65			1,4 HDi (50 kW) / 1,6 HDi (68/84 kW)		
	ET 23					
	€ 67,10	Kegel sw 17 M12 x 1,25 x 26				
RDKS	ASC; ASS; CUC; Huf 2.4; Huf 3.4; Huf 3.5; SE1C1; SE1C2; SE2C1; SE2C2; SE1S; SE2S; TTC					

208				C			
MAGNA	Interio		IN 605 25 4 08	lichtsilber-lackiert / mattschwarz-lackiert			
	6 J x15 H2	185/60R15	ABE				
	4 x 108	185/65R15	ABE				
	ET 25	195/60R15	ABE				
RDKS	ASC; ASS; CUS; Huf 2.4; Huf 3.4; SE1C1; SE1C2; SE1S; TTC; TTS			MK 102	IN	IN	







		C	04/12-	208	
	Schrägheck	163371	9493	PS 516018	Stahl
	1,0i (50 kW)/ 1,2i (60 kW)/ 1,4i (70 kW)/ 1,6i (88/115 kW)/ 1,4 HDi (50 kW)/ 1,6 HDi (68/84 kW)	195/55R16		6 J x16 H2 4x108x65 ET 23	
		Kegel sw 17 M12 x 1,25 x 26		€ 76,60	RDKS
		ASC; ASS; CUC; CUS; Huf 2.4; Huf 3.4; Huf 3.5; SE1C1; SE2C2; SE1S; SE2S; TTC; TTS			







		C	208			
		lichtsilber-lackiert		Celsio	CS 656 26 4 08	MAGMA
		lichtsilber-lackiert / mattschwarz-lackiert		Tezzo	TZ 656 26 4 08	
CS	TZ	ABE	195/50R16	6½ J x16 H2		RDKS
		ABE	195/55R16	4 x 108 ET 26		
MK 102		Celsio: ASC; ASS; CUC; Huf 2.4; Huf 3.4; Huf 3.5; SE1C1; SE1C2; SE1S; TTC; TTS Tezzo: ASC; ASS; CUC; Huf 2.4; Huf 3.4; Huf 3.5; SE1C1; SE1C2; SE1S; TTC				



		C	06/13-	208	
	SUV	154548	7385	PS 515052	Stahl
	1,2i (60 kW)/ 1,6i (88 kW)/ 1,6 HDi (68/84 kW)	195/65R15		6½ J x15 H2 4x108x65 ET 20	
Einige Ausführungen nur 16 Zoll!		Kegel sw 17 M12 x 1,25 x 26		€ 71,90	RDKS

		C	208			
		lichtsilber-lackiert / mattschwarz-lackiert		Tezzo	TZ 655 24 4 08	MAGMA
				ABE	195/65R15	
TZ	TZ	MK 102		ASC; ASS; CUC; Huf 2.4; Huf 3.4; Huf 3.5; SE1C1; SE1C2; SE1S; TTC		RDKS

		C	06/13-	208	
	SUV	163344	9432	PS 516021	Stahl
	1,2i (60 kW)/ 1,6i (88 kW)/ 1,6 HDi (68/84 kW) 1,6 HDi EGS6 (68 kW)	195/60R16 205/55R16		6½ J x16 H2 4x108x65 ET 20	
		Kegel sw 17 M12 x 1,25 x 26		€ 77,10	RDKS
		ASC; ASS; CUC; CUS; Huf 2.4; Huf 3.4; Huf 3.5; SE1S; SE2S; TTC; TTS			

2008				C			
MAGIMA	Interio		IN 706 26 4 08	lichtsilber-lackiert / mattschwarz-lackiert			
	7 J x16 H2	195/55R16	ABE				
	4 x 108						
	ET 26						
RDKS	ASC; CUC; Huf 2.4; Huf 3.4; Huf 3.5; SE1C1; SE1S			MK 102	IN	IN	
307 / 307 SW			06/01-09/07	3 NFU/3 KFU/3 RHY/3 KFW/3 8HZ/3 9HZ/3 9HY			
Stahl	PS 515037	8690	154556	Schrägheck, SW, Break			
	6 J x15 H2	195/65R15		75/90/110/HDi 70/HDi 90/HDi FAP 110			
	4x108x65						
ET 27							
	€ 67,10	Kegel sw 19 M12 x 1,25 x 26					
RDKS							
307 / 307 SW			06/01-09/07	3 NFU/3 RFN/3RFJ/3 8HZ/3 RHY/3 RHS/3 9HY/3 9HZ/3 RHR			
Stahl	PS 516003	9695	163362	Schrägheck, SW, Break			
	6½ J x16 H2	205/55R16		110/135/ 140/HDi 70/HDi 90/HDi 110			
	4x108x65			HDi FAP 110/ HDi FAP 135			
ET 31							
	€ 78,20	Kegel sw 19 M12 x 1,25 x 26					
RDKS							
307 CC			11/03-12/08	3 NFU, 3 RFN, 3 RFJ, 3 RFK			
Stahl	PS 516003	9695	163362	Cabrio			
	6½ J x16 H2	205/55R16		110 (80 kW)/ 135 (100 kW)/ 140 (103 kW)/			
	4x108x65			180 Sport (130 kW)			
ET 31							
	€ 78,20	Kegel sw 19 M12 x 1,25 x 26					
RDKS							
308			10/07-09/13	4			
Stahl	PS 515048	7815	155201	Schrägheck			
	6½ J x15 H2	195/65R15		1,4 95 VTI (70 kW)/ 1,6 120 VTI (88 kW)/			
	4x108x65			1,6 HDi 90 (66 kW)/ 1,6 HDi 110 (80 kW)/ 2,0 HDi (100/103 kW)			
ET 27							
	€ 67,60	Kegel sw 17 M12 x 1,25 x 26					
RDKS							

4		10/07-09/13	308		
	Schrägheck	163366	9783	PS 516015	
	1,4i (70 kW)/ 1,6i (88/103/110/115 kW)/ 1,6 HDi (66/80 kW)/ 2,0 HDi (100/103 kW)	205/55R16		7 J x16 H2	
	2,0 HDi (100 kW)	215/55R16		4x108x65	
	Einige Ausführungen auch 215/55R16 zulässig.	Kegel sw 17 M12 x 1,25 x 26		ET 32 € 79,20	
RDKS					
4		03/09-	308 CC		
	Cabrio	163366	9783	PS 516015	
	1,6 120 VTi (88 kW)/ 2,0 HDi 110 (82 kW)/ 2,0 HDi 135 (100 kW)/ 2,0 HDi 140 (103 kW)	215/55R16		7 J x16 H2	
				4x108x65	
		Kegel sw 17 M12 x 1,25 x 26		ET 32 € 79,20	
ASC; ASS; CUC; CUS; Huf 2.4; Huf 3.4; Huf 3.5; SE1C1; SE1C2; SE2C2; SE1S; SE2S; TTC / OE: Schrader 3002					
RDKS					
4		06/08-04/14	308 SW		
	Kombi	155201	7815	PS 515048	
	1,6 120 VTi (88 kW)/ 1,6 HDi 110 (80 kW)	195/65R15		6½ J x15 H2	
				4x108x65	
		Kegel sw 17 M12 x 1,25 x 26		ET 27 € 67,60	
RDKS					
4		308 / 308 SW			
		lichtsilber-lackiert / mattschwarz-lackiert		Tezzo	
				TZ 655 24 4 08	
		308 CC nur 16 Zoll	ABE	195/65R15 ❄	6½ J x15 H2
			ABE	205/60R15 ❄	4 x 108
MK 102		ASC; ASS; CUC; Huf 2.4; Huf 3.4; Huf 3.5; SE1C1; SE1C2; SE1S; TTC		ET 24	
RDKS					
4		06/08-04/14	308 SW		
	Kombi	163366	9783	PS 516015	
	1,6i (88/103/110/115 kW)/ 1,6 HDi (80 kW)/ 2,0 HDi (100/103 kW)	205/55R16		7 J x16 H2	
	2,0 HDi (100 kW)	215/55R16		4x108x65	
	Einige Ausführungen auch 215/55R16 zulässig.	Kegel sw 17 M12 x 1,25 x 26		ET 32 € 79,20	
RDKS					

308 / 308 CC/ 308 SW			4		
MAGNUM	Interio		IN 706 26 4 08	lichtsilber-lackiert / matschwarz-lackiert	
	7 J x16 EH2+	205/55R16	☼	ABE	
	4 x 108	215/55R16	☼	ABE	
	ET 26				
RDKS	ASC; CUC; Huf 2.4; Huf 3.4; Huf 3.5; SE1C1; SE1S			MK 102	

308			10/13-	L	
Stahl	PS 515053	7823	154579	Schrägheck	
	6½ J x15 H2	195/65R15		1,2i (60/96 kW)/ 1,6i (92 kW)/ 1,6 HDi (68/73/85/88 kW)	
	5x108x65				
	ET 42				
	€ 67,60	Kegel sw 17 M12 x 1,25 x 26		Einige Ausführungen nur 16 Zoll. Einige Ausführungen nur LM.	
RDKS	ASC; ASS; CUC; CUS; Huf 2.4; Huf 3.4; Huf 3.5; SE1C1; SE1C2; SE2C2; SE1S; SE2S; TTC / OE: Schrader 3002				



308			10/13-	L	
Stahl	PS 516023	9833	163379	Schrägheck	
	7 J x16 H2	205/55R16		1,2i (60/96 kW)/ 1,6i (92/115 kW)/ 1,6 HDi (68/73/85/88/110 kW)	
	5x108x65				
	ET 44				
	€ 79,20	Kegel sw 17 M12 x 1,25 x 26		Einige Ausführungen nur LM.	
RDKS	ASC; ASS; CUC; CUS; Huf 2.4; Huf 3.4; Huf 3.5; SE1C1; SE1C2; SE2C2; SE2S; TTC; TTS / OE: Schrader 3002				





308 SW			05/14-	L	
Stahl	PS 515053	7823	154579	Kombi	
	6½ J x15 H2	195/65R15		1,2i (96 kW)/ 1,6i (92 kW)/ 1,6 HDi (68/73/85/88 kW)	
	5x108x65				
	ET 42				
	€ 67,60	Kegel sw 17 M12 x 1,25 x 26		Einige Ausführungen nur 16 Zoll. Einige Ausführungen nur LM.	
RDKS	ASC; ASS; CUC; CUS; Huf 2.4; Huf 3.4; Huf 3.5; SE1C1; SE1C2; SE2C2; SE1S; SE2S; TTC / OE: Schrader 3002				





308 SW			05/14-	L	
Stahl	PS 516023	9833	163379	Kombi	
	7 J x16 H2	205/55R16		1,2i (96 kW)/ 1,6i (92/115 kW)/ 1,6 HDi (68/73/85/88/110 kW)	
	5x108x65				
	ET 44				
	€ 79,20	Kegel sw 17 M12 x 1,25 x 26		Einige Ausführungen nur LM.	
RDKS	ASC; ASS; CUC; CUS; Huf 2.4; Huf 3.4; Huf 3.5; SE1C1; SE1C2; SE2C2; SE2S; TTC; TTS / OE: Schrader 3002				



		L	308		
		lichtsilber-lackiert / mattschwarz-lackiert		Interio	IN 706 45 5 08
		Bremsanlage beachten / Rad nicht frei für 308SW	ABE	195/55R16 * 205/55R16 215/50R16	7 J x16 EH2+ 5 x 108 ET 45
IN	IN	MK 107	ASC; CUC; Huf 2.4; Huf 3.4; Huf 3.5; SE1C1; SE1S		RDKS

		OU, HU	06/09-	3008		
	Mini-Van		163366	9783	PS 516015	
	1,6i (88/115 kW)/ 1,6 HDi (82 kW)/ 2,0 HDi (110/120 kW)/ 2,0 Hybrid (120 kW)		215/60R16		7 J x16 H2 4x108x65 ET 32	
Einige Ausführungen nur 17 Zoll!			Kegel sw 17 M12 x 1,25 x 26		€ 79,20	
		ASC; ASS; CUC; CUS; Huf 2.4; Huf 3.4; Huf 3.5; SE1C1; SE1C2; SE2C2; SE1S; SE2S; TTC / OE: Schrader 3002				RDKS

		OU, HU	3008		
		lichtsilber-lackiert / mattschwarz-lackiert		Interio	IN 706 26 4 08
		Achslasten beachten	ABE	215/60R16 M+S *	7 J x16 EH2+ 4 x 108 ET 26
IN	IN	MK 102	ASC; CUC; Huf 2.4; Huf 3.4; Huf 3.5; SE1C1; SE1S		RDKS

		8*RGX/RFV/DHX/P8C/RHY/RHZ/RFR/BFZ/LFX	10/95-04/04	406	
	Stufenheck, Break		154554	8470	PS 515022
	1,6i/1,8/2,0i/1,9TD/2,1TD/2,0 Hdi 2,0i CT (108 kW)/2,2i (116 kW)		195/65R15 205/60R15		6 J x15 H2 4x108x65 ET 18
Nicht für 3,0i zulässig! 406 Coupé nur GuBräder! Einige Ausführungen des 2,2i nur GuBräder!			Kegel sw 19 M12 x 1,25 x 26		€ 67,10
		RDKS			

		6****, 6*6FY*, 6*6FZ*, 6*9HY*, 6*9HZ*, 6*9FJ*, 6*RFN*, 6*RHL*, 6*RHR*	05/04-02/11	407 / 407 SW	
	Stufenheck, Kombi		163360	9305	PS 516008
	1,8 16V (85 kW)/ 2,0 16V (100 kW)/ 1,6 HDi FAP (80 kW)/ 2,0 HDi FAP (100 kW)		205/60R16		6½ J x16 H2 5x108x65 ET 44
			Kegel sw 17 M12 x 1,25 x 26		€ 82,40
		RDKS			

407 / 407 SW		05/04-02/11	6*****, 6*3FY, 6*3FZ, 6*4HP, 6*4HT, 6*RFJ, 6*RFN, 6*RHL, 6*RHR, 6*UHZ, 6*XFV	
Stahl	PS 517001	9697	175361	Stufenheck, Kombi
	7 J x17 H2	215/55R17		2,0 16V (100 kW)/ 2,2 16V (116 kW)/ 3,0 V6 24V (155 kW)/ 2,0 HDi FAP (100 kW)
	5x108x65 ET 48			
	€ 98,30	Kegel sw 17 M12 x 1,25 x 26		
RDKS				



4007		09/07-05/12	V	
Stahl	MT 516003	9407	163401	SUV
	6½ JJ x16 CH	215/70R16		2,4i (125 kW)/ 2,2 HDi 155 FAP
	5x114,3x67 ET 38			
	€ 90,90	Kegel sw 21 M12 x 1,5		
RDKS				



4007		V	
MAGNA	Tezzo	TZ 656 40 5 14	lichtsilber-lackiert / mattschwarz-lackiert
	6½ J x16 H2	215/70R16	ABE
	5 x 114,3 ET 40		
RDKS		ASC; ASS; CUC; Huf 2.4; Huf 3.4; Huf 3.5; SE1C1; SE1C2; SE1S; TTC	





4008		06/12-	B	
Stahl	PS 516020	9657	163339	SUV
	6½ J x16 CH	215/70R16		1,6i (86 kW)/ 1,6D (84 kW)/ 1,8D (110 kW)
	5x114,3x67 ET 38			
	€ 90,90	Kegel sw 21 M12 x 1,5		
RDKS		ASC; ASS; CUC; Huf 2.4; Huf 3.4; Huf 3.5; SE1C1; SE1C2; SE2C2; SE1S; SE2S; TTS / OE-VDO S180052094Z		





4008		B	
MAGNA	Celsio	CS 656 40 5 14	lichtsilber-lackiert
	Tezzo	TZ 656 40 5 14	lichtsilber-lackiert / mattschwarz-lackiert
	6½ J x16 H2	215/70R16	ABE
	5 x 114,3 ET 40		
RDKS		Celsio: ASC; ASS; CUC; Huf 2.4; Huf 3.4; Huf 3.5; SE1C1; SE1C2; SE1S; TTC; TTS Tezzo: ASC; ASS; CUC; Huf 2.4; Huf 3.4; Huf 3.5; SE1C1; SE1C2; SE1S; TTC / OE-VDO S180052094Z	



		8	03/11-	508 / 508 SW		
	Stufenheck, Kombi	163372	9983	PS 516019		
	1,6i (88/115 kW)/ 1,6 HDi (82 kW)/ 2,0 HDi (103/120 kW)/ Hybrid (120 kW)	215/60R16		7 J x16 H2 5x108x65 ET 47		
		Kegel sw 17 M12 x 1,25 x 26		€ 79,20		
		ASC; ASS; CUC; Huf 2.4; Huf 3.4; SE1C1; SE1C2; SE1S; TTC; TTS / OE: Schrader 3002				RDKS

		8	508 / 508 SW		
		lichtsilber-lackiert / mattschwarz-lackiert		Interio	IN 706 45 5 08
		Rad nicht frei für 508RXH	ABE	215/60R16 ❄	7 J x16 EH2+ 5 x 108 ET 45
IN	IN	MK 107	ASC; CUC; Huf 2.4; Huf 3.4; Huf 3.5; SE1C1; SE1S		RDKS

		0	11/09-	5008		
	Mini-Van	163368	5008	PS 516017		
	1,6 120 VTi (88 kW)/ 1,6 155 THP (115 kW)/ 1,6 HDi 110 (80 kW)/ 2,0 HDi 150 (110 kW)	215/55R16		7 J x16 H2 4x108x65 ET 29		
		Kegel sw 17 M12 x 1,25 x 26		€ 77,10		
		ASC; ASS; CUC; CUS; Huf 2.4; Huf 3.4; Huf 3.5; SE1C1; SE1C2; SE2C1; SE2C2; SE1S; SE2S; TTC / OE: Schrader 3002				RDKS

		225L	02/08-	Bipper		
	Kasten	143695	6805	FL 614004		
	1,4i (54 kW)/ 1,4 HDi (50 kW)	175/70R14		5½ J x14 H2 4x98x58 ET 44		
		Kegel sw 17 M12 x 1,25 x 26		€ 58,10		
		ASC; ASS; Huf 2.4; Huf 3.5; SE2S				RDKS

		225L	02/08-	Bipper		
	Kasten	154594	7680	FL 515013		
	1,4i (54 kW)/ 1,4 HDi (50 kW)	185/65R15		6 J x15 H2 4x98x58 ET 44		
		Kegel sw 17 M12 x 1,25 x 26		€ 66,60		
		ASC; ASS; CUC; CUS; Huf 2.4; Huf 3.4; SE1C1; SE1C2; SE1S; TTC; TTS				RDKS

Bipper Tepee			07/08-	A	
Stahl	*FL 515013	7680	154594	Kombi	
	6 J x15 H2 4x98x58 ET 44	185/65R15		1,4i (54 kW)/ 1,4 HDi (50 kW)	
	€ 66,60	Kegel sw 17 M12 x 1,25 x 26			
RDKS	ASC; ASS; CUC; CUS; Huf 2.4; Huf 3.4; SE1C1; SE1C2; SE1S; TTC; TTS				

Boxer			03/94-03/02	23, 230, 230 D, 230 L, 230 P	
Stahl	*FL 615001	8875	154582	Bus, Kasten, Pritsche	
	6 J x15 H2 5x118x71,1 ET 68	195/70R15		2,0i/1,9D/1,9TD/2,5D/2,5TD/2,8 HDI	
	€ 94,00	Kegel sw 24 M14 x 1,5 x 28		FZG-Schein muss unbedingt beachtet werden: Je nach Ausführung und Motorisierung sind unterschiedliche Reifenabmessungen vorgeschrieben. Bei einigen Ausführungen ist ausschließlich 16 Zoll zulässig.	
RDKS					

Boxer			03/94-03/02	230, 230 D, 230 L, 230 P	
Stahl	*FL 616002	9600	163380	Bus, Kasten, Pritsche	
	6 J x16 H2 5x130x78,1 ET 68	205/75R16		2,0i/2,5D/2,5TD/2,8 HDI	
	€ 107,80	Kegel sw 24 M16 x 1,5 x 31		FZG-Schein muss unbedingt beachtet werden: Je nach Ausführung und Motorisierung sind unterschiedliche Reifenabmessungen vorgeschrieben. Bei einigen Ausführungen ist ausschließlich 15 Zoll zulässig.	
RDKS					

Boxer			04/02-05/06	Z, 244, 244 D, 244 L, 244 M	
Stahl	*FL 615001	8875	154582	Bus, Kasten, Pritsche	
	6 J x15 H2 5x118x71,1 ET 68	195/70R15 205/70R15		2,0i/ 2,0 HDI/ 2,2 HDI/ 2,8 HDI/ 2,0 Bipower	
	€ 94,00	Kegel sw 24 M14 x 1,5 x 28		FZG-Schein muss unbedingt beachtet werden: Je nach Ausführung und Motorisierung sind unterschiedliche Reifenabmessungen vorgeschrieben. Bei einigen Ausführungen ist ausschließlich 16 Zoll zulässig.	
RDKS					

Boxer			04/02-05/06	244, 244 D, 244 L, 244 M	
Stahl	*FL 616002	9600	163380	Bus, Kasten, Pritsche	
	6 J x16 H2 5x130x78,1 ET 68	205/75R16 215/75R16		2,0i/ 2,0 HDI/ 2,2 HDI/ 2,8 HDI/ 2,0 Bipower	
	€ 107,80	Kegel sw 24 M16 x 1,5 x 31		FZG-Schein muss unbedingt beachtet werden: Je nach Ausführung und Motorisierung sind unterschiedliche Reifenabmessungen vorgeschrieben. Bei einigen Ausführungen ist ausschließlich 15 Zoll zulässig.	
RDKS					

		250, 250L, Y	06/06-04/14	Boxer	
	Bus, Kasten, Pritsche	154590	8877	*FL 615002	Stahl
	2,2 HDi (74/81/88/96/110 kW)/ 3,0 HDi (116/130 kW)	205/70R15 215/70R15 225/70R15		6 J x15 H2 5x118x71,1 ET 68	
	FZG-Schein muss unbedingt beachtet werden: Je nach Ausführung und Motorisierung sind unterschiedliche Reifenabmessungen vorgeschrieben.	Kegel sw 21 M14 x 1,5 x 27		€ 94,00	
					RDKS
		250, 250L, Y	06/06-04/14	Boxer	
	Bus, Kasten, Pritsche	154547	4011	FL 615007	Stahl
	2,2 HDi (74/81/88/96/110 kW)/ 3,0 HDi (116/130 kW)	205/70R15 215/70R15 225/70R15		6 J x15 H2 5x118x71,1 ET 68	
	FZG-Schein muss unbedingt beachtet werden: Je nach Ausführung und Motorisierung sind unterschiedliche Reifenabmessungen vorgeschrieben. Ersetzt FL 615002. TPMS modifiziertes Rad.	Kegel sw 21 M14 x 1,5 x 27		€ 94,00	
					RDKS
		Y	04/14-	Boxer	
	Bus, Kasten, Pritsche	154547	4011	FL 615007	Stahl
	2,2 HDi (81/96/110 kW)/ 3,0 HDi (130 kW)	215/70R15 225/70R15		6 J x15 H2 5x118x71,1 ET 68	
	MJ 2014. FZG-Schein muss unbedingt beachtet werden: Je nach Ausführung und Motorisierung sind unterschiedliche Reifenabmessungen vorgeschrieben.			€ 94,00	
		ASC; ASS; CUC; Huf 3.5; SE1C1; SE1C2; SE2C1; SE2C2; SE1S; SE2S; TTC; TTS			RDKS
		Y	04/14-	Boxer	
	Bus, Kasten, Pritsche	163396		FL 616008	Stahl
	2,2 HDi (81/96/110 kW)/ 3,0 HDi (130 kW)	215/75R16 225/75R16		6 J x16 H2 5x118x71,1 ET 68	
	MJ 2014. Je nach Ausführung und Motorisierung sind unterschiedliche Reifenabmessungen vorgeschrieben. Für Fahrzeuge mit Anschluss: 5x118x71,1.			€ 107,80	
					RDKS
		Y	04/14-	Boxer (Heavy)	
	Bus, Kasten, Pritsche	163397	7011	FL 616009	Stahl
	2,2 HDi (81/96/110 kW)/ 3,0 HDi (130 kW)	215/75R16 225/75R16		6 J x16 H2 5x130x78,1 ET 68	
	MJ 2014. Je nach Ausführung und Motorisierung sind unterschiedliche Reifenabmessungen vorgeschrieben. Für Fahrzeuge mit Anschluss: 5x130x78,1.			€ 107,80	
		OE: Schrader 3009			RDKS

Boxer (Heavy)		06/06-04/14	250, 250 B, 250 D, 250 L, Y
Stahl	FL 616004	9601	163381
	6 J x16 H2	215/75R16	
	5x130x78,1 ET 68	225/75R16	
€ 107,80		Kegel sw 21 M16 x 1,5 x 29	
RDKS		FZG-Schein muss unbedingt beachtet werden: Je nach Ausführung und Motorisierung sind unterschiedliche Reifenabmessungen vorgeschrieben.	
Expert		10/06-	G9
Stahl	PS 615002	7670	154559
	6½ J x15 H2	215/65R15	
	5x108x65 ET 38		
€ 84,50		Kegel sw 17 M12 x 1,25 x 26	
RDKS		ASC; ASS; CUC; CUS; Huf 2.4; Huf 3.4; Huf 3.5; SE1C1; SE1C2; SE2C1; SE2C2; SE1S; SE2S; TTC / OE: Schrader 3003	
Expert		10/06-	G9
Stahl	PS 616001	7780	163363
	7 J x16 H2	215/60R16	
	5x108x65 ET 42		
€ 90,90		Kegel sw 17 M12 x 1,25 x 26	
RDKS		ASC; ASS; CUC; CUS; Huf 2.4; Huf 3.4; Huf 3.5; SE1C1; SE1C2; SE2C1; SE2C2; SE1S; SE2S; TTC; TTS / OE: Schrader 3003	
Expert		10/06-	X
Stahl	PS 616001	7780	163363
	7 J x16 H2	215/60R16	
	5x108x65 ET 42		
€ 90,90		Kegel sw 17 M12 x 1,25 x 26	
RDKS		ASC; ASS; CUC; CUS; Huf 2.4; Huf 3.4; Huf 3.5; SE1C1; SE1C2; SE2C1; SE2C2; SE1S; SE2S; TTC; TTS / OE: Schrader 3003	
iOn		01/11-	1
Stahl	PS 515049	7160	154537
	4 J x15 H2	145/65R15	
	4x100x56 ET 35		
€ 82,90		Kegel sw 21 M12 x 1,5	
RDKS		Nur für die Vorderachse zulässig!	

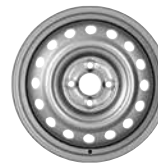



		1	01/11-			iOn
	Schrägheck Elektro (35 kW)	154538	7235	PS 515050		Stahl
		175/55R15		5 J x15 H2 4x100x54 ET 35		
	Nur für die Hinterachse zulässig!	Kegel sw 21 M12 x 1,5		€ 82,90		RDKS
		ASC; ASS; CUC; CUS; Huf 2.4; Huf 3.4; Huf 3.5; SE1S; TTC				
		5	09/96-02/03			Partner
	Kasten 1,1i/1,4i/1,9D/2,0 HdI	143656	6395	PS 614002		Stahl
		175/65R14		5½ J x14 CH 4x108x65 ET 24		
	FZG-Schein beachten, einige Ausführungen nur auf 165/70 R14! Einige Ausführungen ausschließlich 15 Zoll!	Kegel sw 19 M12 x 1,25 x 26		€ 60,20		RDKS
		5*HFx/FHDZ/KFW/FKFX/NFU/FLFX/WJZ/WJY/FDJY/RHY		09/96-02/03	Partner	
	Mini-Van 1,1i/ 1,4i/ 1,6i/ 1,8i/ 1,9D/ 2,0 HDi	143656	6395	PS 614002		Stahl
		175/65R14		5½ J x14 CH 4x108x65 ET 24		
	Typ: 5*HFx/FHDZ/KFW/FKFX/NFU/FLFX/WJZ/WJY/FDJY/RHY FZG-Schein beachten. Einige Ausführungen mit 175/70R14 Bereifung. Bei einigen Ausführungen nur 15 Zoll zulässig.	Kegel sw 19 M12 x 1,25 x 26		€ 60,20		RDKS
		5 NFU, 5 RHY	09/96-02/03			Partner
	Mini-Van 1,6i (80 kW)/ 2,0 HDi (66 kW)	154557	8475	PS 515039		Stahl
		185/65R15		6 J x15 CH 4x108x65 ET 18		
	FZG-Schein beachten! Bei einigen Ausführungen nur 14 Zoll zulässig.	Kegel sw 19 M12 x 1,25 x 26		€ 67,10		RDKS
		G KFW, G WJY, G RHY, G WJY, G 9HW, G 9HX		03/03-04/08	Partner	
	Mini-Van 1,4i (55 kW)/ 1,4 BiFuel (55 kW)/ 1,9D (51 kW)/ 1,6 HDi 75 (55kW)/ 1,6 HDi 90 (66 kW)/ 2,0 HDi 90 (66 kW)	143656	6395	PS 614002		Stahl
		175/70R14		5½ J x14 CH 4x108x65 ET 24		
	FZG-Schein beachten! Bei einigen Ausführungen des 2,0 HDi nur 15 Zoll zulässig.	Kegel sw 19 M12 x 1,25 x 26		€ 60,20		RDKS



Partner			03/03-04/08	M59, M 59 GL, M 59 GN	
Stahl	PS 614002	6395	143656	Kasten	
	5½ J x14 CH	175/65R14		1,4i (55 kW) / 1,4 BiFuel (55 kW) /	
	4x108x65			1,9D (51 kW) / 1,6 HDi 75 (55 kW) /	
	ET 24			1,6 HDi 90 (66 kW) / 2,0 HDi (66 kW)	
	€ 60,20	Kegel sw 19 M12 x 1,25 x 26			
RDKS					



Partner			03/03-04/08	G NFU, G RHY, G 9HW, G 9HX	
Stahl	PS 515039	8475	154557	Mini-Van	
	6 J x15 CH	185/65R15		1,6i-16V (80 kW) / 1,6 HDi 75 (55 kW) /	
	4x108x65			1,6 HDi 90 (66 kW) / 2,0 HDi 90 (66 kW)	
	ET 18				
	€ 67,10	Kegel sw 19 M12 x 1,25 x 26		FZG-Schein beachten! Bei einigen Ausführungen des 2,0 HDi nur 14 Zoll zulässig.	
RDKS					

Partner			05/08-	B9	
Stahl	PS 615003	8477	154561	Kasten	
	6½ J x15 H2	195/65R15		1,6i 16V (66 kW) / HDi 75 (55 kW) / HDi 90 (66 kW)	
	4x108x65	195/70R15			
	ET 27				
	€ 76,10	Kegel sw 17 M12 x 1,25 x 26			
RDKS			ASC ; ASS ; CUC ; Huf 2.4 ; Huf 3.4 ; Huf 3.5 ; SE1C1 ; SE1C2 ; SE2C1 ; SE2C2 ; SE1S ; SE2S ; TTC / OE: Schrader 3002		

Partner Origin			05/08-	G KFW, G 9HW, G 9HX	
Stahl	PS 614002	6395	143656	Mini-Van	
	5½ J x14 CH	175/70R14		1,4i (54 kW) / 1,6 HDi 75 (55 kW) / 1,6 HDi 90 (66 kW)	
	4x108x65				
	ET 24				
	€ 60,20	Kegel sw 19 M12 x 1,25 x 26		Alte Baureihe des Peugeot Partner, die parallel zur neuen Baureihe (Typ: 7) weitergebaut wird.	
RDKS			ASC ; ASS ; CUC ; Huf 2.4 ; Huf 3.4 ; Huf 3.5 ; SE1C1 ; SE1C2 ; SE2C1 ; SE2C2 ; SE1S ; SE2S ; TTC		

Partner Origin			05/08-	M59	
Stahl	PS 614002	6395	143656	Kasten	
	5½ J x14 CH	175/65R14		1,4i (55 kW) / 1,6 HDi 90 (66 kW) / 1,9D (51 kW)	
	4x108x65				
	ET 24				
	€ 60,20	Kegel sw 19 M12 x 1,25 x 26		Alte Baureihe des Peugeot Partner, die parallel zur neuen Baureihe (Typ: B9) weitergebaut wird.	
RDKS			ASC ; ASS ; CUC ; Huf 2.4 ; Huf 3.4 ; Huf 3.5 ; SE1C1 ; SE1C2 ; SE2C1 ; SE2C2 ; SE1S ; SE2S ; TTC		

		G 9HW, G 9HX	05/08-	Partner Origin	
	Mini-Van	1,6 HDi 75 (55 kW) / 1,6 HDi 90 (66 kW)	154557	8475	PS 515039
			185/65R15		6 J x15 CH 4x108x65 ET 18
	Alte Baureihe des Peugeot Partner, die parallel zur neuen Baureihe (Typ: 7) weitergebaut wird.		Kegel sw 19 M12 x 1,25 x 26		€ 67,10
RDKS					
		7	05/08-	Partner Tepee	
	Mini-Van	1,6i 16V (66/80 kW) / HDi 75 (55 kW) / HDi 90 (66 kW) / HDi 110 (80 kW)	154561	8477	PS 615003
			195/65R15 195/70R15 205/65R15		6½ J x15 H2 4x108x65 ET 27
	Je nach Ausführung unterschiedliche Reifenabmessungen zulässig.		Kegel sw 17 M12 x 1,25 x 26		€ 76,10
RDKS					
		7	05/08-	Partner Tepee	
	Mini-Van	1,6i 16V (66/80 kW) / HDi 75 (55 kW) / HDi 90 (66 kW) / HDi 110 (80 kW)	163364	7860	PS 516012
			215/55R16		6½ J x16 H2 4x108x65 ET 26
			Kegel sw 17 M12 x 1,25 x 26		€ 77,10
RDKS					

		9PA, 92A, 92AN, 92AH, 92AHN		Cayenne / Cayenne II	
		lichtsilber-lackiert / mattschwarz-lackiert		Seismo	SO 808 55 5 30
		Bereifung 235/60R18 M+S nur für Cayenne I (9PA) Bis 1.800kg zulässig!	ABE	235/60R18 M+S ❄	8 J x18 H2 5 x 130 ET 55
			ABE	255/55R18 ❄	
		Serie		ASC; ASS; CUC; Huf 2.4; Huf 3.4; Huf 3.5; SE1C1; SE1C2; SE15; TTC / OE: Huf 100056	
RDKS					

Captur		06/13-	R
Stahl	RE 516020	8312	163376
	6½ J x16 H2	163376	
	4x100x60	163376	
	ET 40		
	€ 78,20	Kegel sw 17 M12 x 1,5 x 26	
RDKS	0E: Schrader 3041		



Clio II		09/98-08/05	B
Stahl	RE 514009	6530	143666
	5½ J x14 CH	143666	
	4x100x60	143666	
	ET 36	175/65R14	
	€ 60,20	Kegel sw 19 M12 x 1,5 x 25	
RDKS			



Clio II		06/00-08/05	B
Stahl	RE 515015	8175	154566
	6 J x15 H2	154566	
	4x100x60	154566	
	ET 43	185/55R15	
	€ 71,30	Kegel sw 19 M12 x 1,5 x 25	
RDKS	Bei einigen Ausführungen nur 14 Zoll zulässig. FZG-Schein beachten! Einige Ausführungen des 2,0i 16-V nur LM-Räder.		



Clio II Campus		09/05-04/13	B
Stahl	RE 514009	6530	143666
	5½ J x14 CH	143666	
	4x100x60	143666	
	ET 36	175/65R14	
	€ 60,20	Kegel sw 19 M12 x 1,5 x 25	
RDKS	Alte Baureihe des Renault Clio, die parallel zur neuen Baureihe (Typ: R) weitergebaut wird.		





Clio II Campus		09/05-04/13	B
Stahl	RE 515015	8175	154566
	6 J x15 H2	154566	
	4x100x60	154566	
	ET 43	185/55R15	
	€ 71,30	Kegel sw 19 M12 x 1,5 x 25	
RDKS	Alte Baureihe des Renault Clio, die parallel zur neuen Baureihe (Typ: R) weitergebaut wird.		





		R	09/05-09/12	Clio III	
	Schrägheck, Grandtour	154572	7935	RE 515020	Stahl
	1,2-16V (48/55 kW)	165/65R15		5½ J x15 H2 4x100x60 ET 43	
		Kegel sw 17 M12 x 1,5 x 26		€ 72,40	RDKS

		R	09/05-09/12	Clio III	
	Schrägheck, Grandtour	154573	7965	RE 515021	Renner
	1,2-16V (48/55 kW) / 1,2-16V TCE (74 kW) / 1,6-16V (65/82 kW) / 1,5 dCi (50/63/76 kW)	175/65R15 185/60R15		6 J x15 H2 4x100x60 ET 50	
FZG-Schein beachten! Rad nicht für alle Ausführungen zulässig!		Kegel sw 17 M12 x 1,5 x 26		€ 74,50	RDKS



		R	05/13-	Clio III Collection	
	Schrägheck, Grandtour	154572	7935	RE 515020	Stahl
	1,2i-16V (55 kW)	165/65R15		5½ J x15 H2 4x100x60 ET 43	
Alte Baureihe des Renault Clio III, die parallel zur neuen Baureihe weitergebaut wird.		Kegel sw 17 M12 x 1,5 x 26		€ 72,40	RDKS

		R	05/13-	Clio III Collection	
	Schrägheck, Grandtour	154573	7965	RE 515021	Renner
	1,2i-16V (55 kW)	175/65R15 185/60R15		6 J x15 H2 4x100x60 ET 50	
FZG-Schein beachten! Rad nicht für alle Ausführungen zulässig! Alte Baureihe des Renault Clio III, die parallel zur neuen Baureihe weitergebaut wird.		Kegel sw 17 M12 x 1,5 x 26		€ 74,50	RDKS



		R	Clio III		
		lichtsilber-lackiert / mattschwarz-lackiert		Interio	IN 605 38 4 00
		Serienbereifung beachten		ABE 165/65R15 ❄	6 J x15 H2 4 x 100
				ABE 175/60R15 ❄	
				TÜV 185/60R15 ❄	
IN	IN	MK 216	ASC; ASS; CUS; Huf 2.4; Huf 3.4; SE1C1; SE1C2; SE1S; TTC; TTS		

ACCOMPAGNARE
MAGMA

RDKS

Clio III				R	
MAGNA	Celsio	CS 655 35 4 00	lichtsilber-lackiert	 	
	Tezzo	TZ 655 35 4 00	lichtsilber-lackiert / mattschwarz-lackiert		
	6½ J x15 H2	175/65R15 ☼	ABE		Serienbereifung beachten
	4 x 100	185/60R15 ☼	TÜV		
ET 35					
RDKS	Celsio: ASC; ASS; CUC; Huf 2.4; Huf 3.4; Huf 3.5; SE1C1; SE1C2; SE1S; TTC; TTS Tezzo: ASC; ASS; CUC; Huf 2.4; Huf 3.4; Huf 3.5; SE1C1; SE1C2; SE1S; TTC			MK 216	

Clio IV			10/12-	R	
Renner	RE 515027	7777	154522		
	6 J x15 H2	185/65R15			Schrägheck, Grandtour
	4x100x60				1,2 16V (47/54 kW)/ Tce 90 (66 kW)/ dCi 75 (55 kW)/ dCi 90 (66 kW)
	ET 40				
€ 74,50	Kegel sw 17 M12 x 1,5 x 26		Nicht Tce 120 (88 kW)		
RDKS	ASC; ASS; CUC; Huf 2.4; Huf 3.4; Huf 3.5; SE1C1; SE1C2; SE2C1; SE2C2; SE1S; SE2S; TTC / OE: Schrader 3073				

Clio IV				R
MAGNA	Interio	IN 605 38 4 00	lichtsilber-lackiert / mattschwarz-lackiert	 
	6 J x15 H2	185/65R15 ☼	ABE	
	4 x 100	195/60R15 ☼	ABE	
	ET 38	205/55R15 ☼	ABE	
RDKS	ASC; ASS; CUS; Huf 2.4; Huf 3.4; SE1C1; SE1C2; SE1S; TTC; TTS			MK 216

Espace				K
MAGNA	Celsio	CS 707 47 5 08	lichtsilber-lackiert	
	7 J x17 EH2+	225/55R17	ABE	
	5 x 108			
	ET 47			
RDKS	ASC; ASS; CUC; Huf 2.4; Huf 3.4; Huf 3.5; SE1C1; SE1C2; SE1S; TTC			MK 304

Espace			04/15-	RFC
Stahl	RE 517005	9006	175305	Van
	7 J x17 H2	235/65R17		1,6i (147 kW)/ 1,6 dCi (96/118 kW)
	5x114,3x66			
	ET 37			
€ 98,30				
RDKS				Radabbildung in Vorbereitung

		RFC	Espace (Neues Modell)		KRONPRINZ MAGMA
Radabbildung in Vorbereitung					
				in Vorbereitung	
					RDKS

		Z	03/10-10/12	Fluence	
	Stufenheck		154576	7305 / 7306	RE 515026
	1,6 16V (81 kW)/ 2,0 16V (103 kW)/ dCi 90 (66 kW)/ dCi 110 (81 kW)		205/65R15		6½ J x15 H2 5x114,3x66 ET 43
			Kegel sw 17 M12 x 1,5 x 26		€ 70,80
					RDKS

		Z	03/10-10/12	Fluence	
	Stufenheck		163359	9563	RE 516013
	1,6 16V (81 kW)/ 2,0 16V (103 kW)/ dCi 90 (66 kW)/ dCi 110 (81 kW)		205/60R16		6½ J x16 H2 5x114,3x66 ET 47
			Kegel sw 17 M12 x 1,5 x 26		€ 78,20
					RDKS

		LZ	03/11-	Fluence Z.E.	
	Stufenheck		163359	9563	RE 516013
	Elektro		205/55R16		6½ J x16 H2 5x114,3x66 ET 47
			Kegel sw 17 M12 x 1,5 x 26		€ 78,20
					RDKS
					ASS; CUC; Huf 2.4; Huf 3.4; Huf 3.5; SE1C1; SE1C2; SE2C1; SE2C2; SE1S; SE2S

		RFE	07/15-	Kadjar	
	SUV		163443	7856	NI 516005
	1,2 TCE (96 kW)/ 1,5 dCi (81 kW)/ 1,6 dCi (96 kW)		215/65R16		6½ JJ x16 CH 5x114,3x66 ET 40
	Einige Ausführungen nur 17 Zoll.				€ 85,60
					RDKS
					ASC; ASS; CUC; CUS; Huf 2.4; Huf 3.4; Huf 3.5; SE1C1; SE1C2; SE2C2; SE1S; SE2S; TTC/ OE:VDO

Kadjar			RFE
KRONPRINZ MAGMA	in Vorbereitung		Radabbildung in Vorbereitung
RDKS			

Kangoo		05/98-12/07	KC	
Stahl	RE 514009	6530	143666	Kombi
	5½ J x14 CH	165/70R14		1,2i (43 kW)/ 1,2i-16V (55 kW)/ 1,4i (55 kW)/
	4x100x60	165/75R14		1,6i-16V (70 kW)/ 1,5 dCi (48/60 kW)/
	ET 36	175/65R14		1,9D (40/47/59 kW)
€ 60,20	Kegel sw 19 M12 x 1,5 x 25		RE 514009 bis 1000 kg Achslast zulässig! Nicht für 4x4 zulässig. Je nach Ausführung unterschiedliche Reifenabmessungen zulässig. M+S Auflagen beachten. Einige Ausführungen nur 15 Zoll.	
RDKS				



Kangoo		01/08-	W	
Stahl	RE 514019	6335	143675	Kombi
	5½ J x14 H2	185/70R14		1,6i-16V (64 kW)/ 1,5 dCi (50 kW)
	4x100x60			
	ET 45			
€ 64,50	Kegel sw 17 M12 x 1,5 x 26		Für Fahrzeuge mit 4-Loch Anschluss.	
RDKS		ASS; CUC; Huf 3.5; SE1C1; SE1C2; SE2C1; SE1S; SE2S; TTS / OE: Schrader 3041		



Kangoo		01/08-	W	
Stahl	RE 515023	7215	154574	Kombi
	6 J x15 H2	195/65R15		1,6i-16V (78 kW)/ 1,5 dCi (50/55/63/66/76 kW)
	5x108x60			
	ET 44			
€ 75,00	Kegel sw 17 M12 x 1,5 x 26		Für Fahrzeuge mit 5-Loch Anschluss.	
RDKS		ASC; ASS; CUC; Huf 2.4; Huf 3.4; Huf 3.5; SE1C1; SE1C2; SE2C1; SE2C2; SE1S; SE2S; TTC / OE: Schrader 3041		





Kangoo Be Bo		04/09-	W	
Stahl	RE 514019	6335	143675	Kombi
	5½ J x14 H2	185/70R14		1,6i-16V (64 kW)/ 1,5 dCi (50 kW)
	4x100x60			
	ET 45			
€ 64,50	Kegel sw 17 M12 x 1,5 x 26		Für Fahrzeuge mit 4-Loch Anschluss.	
RDKS		ASS; CUC; Huf 3.5; SE1C1; SE1C2; SE2C1; SE1S; SE2S; TTS / OE: Schrader 3041		



		W	04/09-	Kangoo Be Bop		
	Kombi		154574	7215	RE 515023	
	1,6i-16V (78 kW)/ 1,5 dCi (66/76 kW)		195/65R15		6 J x15 H2 5x108x60 ET 44	
	Für Fahrzeuge mit 5-Loch Anschluss.		Kegel sw 17 M12 x 1,5 x 26		€ 75,00	
			ASC; ASS; CUC; Huf 2.4; Huf 3.4; Huf 3.5; SE1C1; SE1C2; SE2C1; SE2C2; SE1S; SE2S; TTC / OE: Schrader 3041			RDKS

		KC	01/08-	Kangoo Campus		
	Kombi		143666	6530	RE 514009	
	1,2i-16V (55 kW)/ 1,5 dCi (50 kW)		165/70R14 175/65R14		5½ J x14 CH 4x100x60 ET 36	
	Alte Baureihe des Renault Kangoo, die parallel zur neuen Baureihe (Typ: W) weitergebaut wird. Je nach Ausführung unterschiedliche Reifenabmessungen zulässig.		Kegel sw 19 M12 x 1,5 x 25		€ 60,20	
						RDKS

		FW	01/08-	Kangoo Rapid		
	Kasten		143675	6335	RE 514019	
	1,5 dCi (50/63 kW)		185/70R14		5½ J x14 H2 4x100x60 ET 45	
	Für Fahrzeuge mit 4-Loch Anschluss.		Kegel sw 17 M12 x 1,5 x 26		€ 64,50	
			ASS; CUC; Huf 3.5; SE1C1; SE1C2; SE2C1; SE1S; SE2S; TTS / OE: Schrader 3041			RDKS



		FW	01/08-	Kangoo Rapid		
	Kasten		154574	7215	RE 515023	
	1,6i-16V (78 kW)/ 1,5 dCi (50/63/76 kW)		195/65R15		6 J x15 H2 5x108x60 ET 44	
	Für Fahrzeuge mit 5-Loch Anschluss.		Kegel sw 17 M12 x 1,5 x 26		€ 75,00	
			ASC; ASS; CUC; Huf 2.4; Huf 3.4; Huf 3.5; SE1C1; SE1C2; SE2C1; SE2C2; SE1S; SE2S; TTC / OE: Schrader 3041			RDKS

		Y	Koleos				
		lichtsilber-lackiert	Celsio		CS 707 38 5 14		
			ABE	225/55R17 *	7 J x17 EH2+	5 x 114,3	
			ABE	225/60R17			
			ABE	235/55R17 *			ET 38
CS	MK 018		ASC; ASS; CUC; Huf 2.4; Huf 3.4; Huf 3.5; SE1C1; SE1C2; SE1S; TTC				RDKS

Laguna II			03/01-09/07	G	
Stahl	RE 516009	9435	163352	Schrägheck, Grandtour	
	6½ J x16 H2	205/55R16		1,6 16V (79 kW)/ 1,8 16V (88 kW)/	
	5x108x60			2,0 16V (99/120 kW)/ 3,0 V6 24V (152 kW)/	
	ET 50			1,9 dCi (74/88 kW)/ 2,2 dCi (102/110 kW)	
€ 78,20		Kegel sw 19 M12 x 1,5 x 23		FZG-Schein beachten. Bei einigen Ausführungen nur 205/60R16 zulässig. Nur zulässig bei Brems Scheibendurchmesser max. 300mm.	
RDKS					

Laguna III			10/07-11/15	T	
Stahl	RE 516015	9583	163358	Stufenheck, Kombi	
	7 J x16 H2	205/60R16		1,6i-16V (81 kW)/ 2,0i-16V (103 kW)/	
	5x114,3x66	215/60R16		1,5 dCi (81 kW)/ 2,0 dCi (96/110 kW)	
	ET 47	215/55R16		2,0 dCi (96/127/131 kW)	
€ 78,20		Kegel sw 17 M14 x 1,5 x 25		FZG-Schein muss unbedingt beachtet werden: Je nach Ausführung und Motorisierung sind unterschiedliche Reifenabmessungen vorgeschrieben.	
RDKS ASC; ASS; CUC; Huf 3.5; SE1C1; SE1S / OE: VDO S180052064Z					

Laguna III			10/07-11/15	T	
Stahl	RE 516015	9583	163358	Stufenheck, Kombi	
	7 J x16 H2	215/60R16		2,0i-16V Turbo (125 kW)	
	5x114,3x66	215/55R16			
	ET 47				
€ 78,20		Kegel sw 17 M14 x 1,5 x 25		FZG-Schein muss unbedingt beachtet werden: Je nach Ausführung und Motorisierung sind unterschiedliche Reifenabmessungen vorgeschrieben.	
RDKS ASC; ASS; CUC; Huf 3.5; SE1C1; SE1S / OE: VDO S180052064Z					

Laguna III				T			
MAGNA	Interio		IN 706 45 5 14	lichtsilber-lackiert / mattschwarz-lackiert			
	7 J x16 EH2+	205/60R16	⊗	ABE			Bereifung 205/60R16 nicht für alle Modelle
	5 x 114,3	215/55R16	⊗	ABE			
	ET 45	215/60R16		ABE			
RDKS ASC; CUC; Huf 2.4; Huf 3.4; Huf 3.5; SE1C1; SE1S						IN	IN
						MK 318	

Latitude			12/10-10/12	T	
Stahl	RE 516015	9583	163358	Stufenheck	
	7 J x16 H2	205/60R16		2,0 16V eco2 (103 kW)/ 1,5 dCi (81 kW)	
	5x114,3x66	215/55R16		1,5 dCi (81 kW)/ 2,0 dCi (110/127 kW)	
	ET 47				
€ 78,20		Kegel sw 17 M14 x 1,5 x 25		Nicht für 3,0 V6 dCi (177 kW)!	
RDKS					

		ED, FD, UD, HD, JD, MD, ND	08/00-03/10	Master	
	Transporter	163351	9495	RE 616003	Stahl
	1,9 DTi/2,2 dCi/ 2,5 dCi/ 2,5D/2,8DTi (84 kW)	195/65R16		6 J x16 H2	
	2,2 dCi/ 2,5 dCi/ 2,5D/2,8DTi/3,0 dCi (100 kW)	215/65R16		5x130x89	
		225/65R16		ET 66	
	Je nach Ausführung unterschiedliche Reifenabmessungen vorgeschrieben! RE 616003 nur in Verbindung mit 4 Bremscheiben! Bei einigen Ausführungen auch 205/75R16 zulässig.	Kugel sw 19 M14 x 1,5 x 30		€ 90,90	RDKS
		MA, MB, MC, MD	04/10-	Master	
	Transporter	163346	8733	RE 616015	Stahl
	dCi 125 (92 kW)/ dCi 135 (100 kW)/ dCi 150 (107/110 kW)/ dCi 165 (120 kW)	195/75R16C		5½ J x16 H2	
				6x200x142,1	
				ET 110	
	Rad für Zwillingbereifung! Auch Vorderachse. Rad für 3,5t / 4,5t mit Heckantrieb!			€ 118,60	RDKS
		MA, MB, MF, MG, ML, MI, MM, VA, VB, VF, VG	04/10-	Master	
	Transporter	163348	9133	RE 616012	Stahl
	dCi 100/ dCi 110 => 2,8t-3,3t Ecoline	215/65R16C		6½ J x16 H2	
	dCi 100/ dCi 110/ dCi 125/ dCi 135/ dCi 150/ dCi 165 => 3,3t	215/65R16C		5x130x89	
	dCi 100/ dCi 110/ dCi 125/ dCi 135/ dCi 150/ dCi 165 => 3,5t	225/65R16C		ET 66	
	Rad für Singlebereifung! Rad für 2,8t-3,3t / 3,5t mit Frontantrieb!	Kegel sw 19 M14 x 1,5 x 30		€ 87,70	
	Je nach Ausführung unterschiedliche Reifenabmessungen vorgeschrieben!	Huf 3.5; SE1C1 ; SE2C1 ; SE1S ; SE2S / OE: Schrader 3041		RDKS	
		MA, MB, MF, MG, ML, MM, VA, VB, VF, VG	04/10-	Master	
	Transporter	163349	9367	RE 616013	Stahl
	dCi 125 (92 kW)/ dCi 135 (100 kW)/ dCi 150 (107/110 kW)/ dCi 165 (120 kW)	235/65R16C		7 J x16 H2	
				5x130x89	
				ET 66	
	Rad für Singlebereifung! Rad für 3,5t mit Heckantrieb! Je nach Ausführung unterschiedliche Reifenabmessungen vorgeschrieben!	Kegel sw 19 M14 x 1,5 x 30		€ 88,20	RDKS
		Huf 3.5; SE1C1 ; SE2C1 ; SE1S ; SE2S / OE: Schrader 3041			
		*	05/07-	Maxity	
	Transporter	154605		RE 615005	Stahl
	DXi 2,5 (90/100 kW)/ DXi 3 (110 kW)	195/70R15		5 J x15 H2	
				5x170x130	
				ET 106,5	
				€ 89,00	RDKS

Mégane			01/96-09/02	BA	
Stahl	RE 514009	6530	143666	Schrägheck	
	5½ J x14 CH	175/70R14		1,4/1,6 (55 kW)/1,6e (66 kW)/2,0i (80/84 kW)/	
	4x100x60			1,9dT (72 kW)	
	ET 36	175/65R14		1,9d/1,9dT	
€ 60,20		Kegel sw 19 M12 x 1,5 x 25			
RDKS					

Mégane			05/99-09/02	KA, LA, DA, EA	
Stahl	RE 515015	8175	154566	Grandtour, Classic, Coupé, Cabrio	
	6 J x15 H2	185/60R15		1,6-16V (79 kW)/2,0i (80/84 kW)/	
	4x100x60			2,0-16V (108 kW)/1,9 dTi (72 kW)	
	ET 43				
€ 71,30		Kegel sw 19 M12 x 1,5 x 25			
RDKS					

Mégane			05/99-09/02	BA	
Stahl	RE 515015	8175	154566	Schrägheck	
	6 J x15 H2	185/55R15		1,4/1,6 (55 kW)/1,6e (66 kW)/1,9dT (72 kW)	
	4x100x60	185/60R15		1,6-16V (79 kW)/2,0i (80/84 kW)	
	ET 43				
€ 71,30		Kegel sw 19 M12 x 1,5 x 25			
RDKS					

Mégane			08/99-09/02	DA, EA	
Stahl	RE 515015	8175	154566	Coupé, Cabrio	
	6 J x15 H2	185/55R15 M+S		2,0 ide (103 kW)	
	4x100x60				
	ET 43				
€ 71,30		Kegel sw 19 M12 x 1,5 x 25			
RDKS					

Mégane			04/00-09/02	BA	
Stahl	RE 515015	8175	154566	Schrägheck	
	6 J x15 H2	185/60R15		2,0 ide (103 kW)	
	4x100x60				
	ET 43				
€ 71,30		Kegel sw 19 M12 x 1,5 x 25			
RDKS					

		KA	01/99-09/02	Mégane Break	
	Kombi	143666	6530	RE 514009	Stahl
	1,4-16V (70 kW)/1,9dTi (47 kW)	175/70R14		5½ J x14 CH 4x100x60 ET 36	
		Kegel sw 19 M12 x 1,5 x 25		€ 60,20	
RDKS					
		EA	04/97-09/02	Mégane Cabrio	
	Cabrio	143666	6530	RE 514009	Stahl
	1,4-16V (70 kW)/1,6e (66 kW)/2,0i (80/84 kW)	175/65R14		5½ J x14 CH 4x100x60 ET 36	
		Kegel sw 19 M12 x 1,5 x 25		€ 60,20	
RDKS					
		LA	02/97-09/02	Mégane Classic	
	Stufenheck	143666	6530	RE 514009	Stahl
	1,6 (55 kW)/1,6e (66 kW)/2,0i (80/84 kW)	175/65R14		5½ J x14 CH	
	1,9d/1,9dT/1,9dTi (72 kW)	175/70R14		4x100x60 ET 36	
		Kegel sw 19 M12 x 1,5 x 25		€ 60,20	
RDKS					
		LA	02/97-09/02	Mégane Classic	
	Stufenheck	154566	8175	RE 515015	Stahl
	2,0i (80/84 kW)/1,9dTi (72 kW)	185/60R15		6 J x15 H2 4x100x60 ET 43	
		Kegel sw 19 M12 x 1,5 x 25		€ 71,30	
RDKS					
		DA	01/96-09/02	Mégane Coupé	
	Coupé	143666	6530	RE 514009	Stahl
	1,6e (66 kW)/1,6-16V (79 kW)/2,0	175/65R14		5½ J x14 CH	
	1,9dTi (72 kW) ab 03/98-	175/70R14		4x100x60 ET 36	
		Kegel sw 19 M12 x 1,5 x 25		€ 60,20	
RDKS					

Mégane II / Mégane II CC			10/02-10/08	M	
Stahl	RE 515019	8715	154571	Schräg-/Stufenheck, Grandtour, Cabrio	
	6½ J x15 H2	195/65R15		1,4i-16V/ 1,6i-16V/ 1,5 dCi / 1,9 dCi (88/96 kW)	
	4x100x60 ET 45				
	€ 70,80	Kegel sw 17 M12 x 1,5 x 26			
RDKS					

Mégane II / Mégane II CC			10/02-10/08	M	
Stahl	RE 516010	9985	163355	Schräg-/Stufenheck, Grandtour, Cabrio	
	6½ J x16 H2	205/55R16		1,4i-16V/ 1,6i-16V/ 2,0i-16V (99 kW)/ 2,0T-16V (120 kW)/ 1,5 dCi / 1,9 dCi (88/96 kW)	
	4x100x60 ET 49				
	€ 78,20	Kegel sw 17 M12 x 1,5 x 26		2,0 16V (165 kW) nur LM-Guss Räder zulässig!	
RDKS					

Mégane III			11/08-12/15	Z	
Stahl	RE 515026	7305 / 7306	154576	5-Türer	
	6½ J x15 H2	195/65R15		1,6 16V 100 (74 kW)/ 1,6 16V 110 (81 kW)/ 1,2 TCE 115 (85 kW)/ 1,4 TCE 130 (96 kW)/ 2,0 16V 140 (103 kW)/ 1,5 dCi 90 (66 kW)/ 1,5 dCi 95 (70 kW)/ 1,5 dCi 110 (78/81 kW)	
	5x114,3x66 ET 43				
	€ 70,80	Kegel sw 17 M12 x 1,5 x 26			
RDKS ASS; CUC; Huf 2.4; Huf 3.4; Huf 3.5; SE1C1; SE1C2; SE2C1; SE2C2; SE1S; SE2S					

Mégane III			11/08-12/15	Z	
Stahl	RE 516013	9563	163359	5-Türer	
	6½ J x16 H2	205/55R16		1,6 16V 100 (74 kW)/ 1,6 16V 110 (81 kW)/ 1,2 TCE 115 (85 kW)/ 1,4 TCE 130 (96 kW)/ 2,0 16V 140 (103 kW)/ 1,5 dCi 90 (66 kW)/ 1,5 dCi 95 (70 kW)/ 1,5 dCi 110 (78/81 kW)/ 1,9 dCi 130 (96 kW)	
	5x114,3x66 ET 47				
	€ 78,20	Kegel sw 17 M12 x 1,5 x 26			
RDKS ASS; CUC; Huf 2.4; Huf 3.4; Huf 3.5; SE1C1; SE1C2; SE2C1; SE2C2; SE1S; SE2S					



Mégane III			01/09-12/15	Z	
Stahl	RE 515026	7305 / 7306	154576	Coupé	
	6½ J x15 H2	195/65R15		1,6 16V 110 (81 kW)/ 1,2 TCE 115 (85 kW)/ 1,4 TCE 130 (96 kW)/ 2,0 16V 140 (103 kW)/ 1,5 dCi 110 (78/81 kW)	
	5x114,3x66 ET 43				
	€ 70,80	Kegel sw 17 M12 x 1,5 x 26			
RDKS ASS; CUC; Huf 2.4; Huf 3.4; Huf 3.5; SE1C1; SE1C2; SE2C1; SE2C2; SE1S; SE2S					

		Z	05/09-12/15	Mégane III	
	Grandtour		154576	7305 / 7306	RE 515026
	1,6 16V 110 (81 kW)/ 1,2 TCE 115 (85 kW)/ 1,4 TCE 130 (96 kW)/ 2,0 16V 140 (103 kW)/ 1,5 dCi 90 (66 kW)/ 1,5 dCi 95 (70 kW)/ 1,5 dCi 110 (78/81 kW)		195/65R15		6½ J x15 H2 5x114,3x66 ET 43
			Kegel sw 17 M12 x 1,5 x 26		€ 70,80
			ASS; CUC; Huf 2.4; Huf 3.4; Huf 3.5; SE1C1; SE1C2; SE2C1; SE2C2; SE1S; SE2S		RDKS

		Z	Mégane III		
			lichtsilber-lackiert / mattschwarz-lackiert		Tezzo TZ 655 45 5 14
		Serienbereifung beachten	ABE	195/65R15 ❄	6½ J x15 H2 5 x 114,3 ET 45
	ABE	205/60R15 ❄			
	ABE	215/60R15 ❄			
TZ	TZ	MK 217	ASC; ASS; CUC; Huf 2.4; Huf 3.4; Huf 3.5; SE1C1; SE1C2; SE1S; TTC / OE: VDO S180052064Z		RDKS

		Z	05/09-12/15	Mégane III	
	Grandtour		163359	9563	RE 516013
	1,6 16V 110 (81 kW)/ 1,2 TCE 115 (85 kW)/ 1,4 TCE 130 (96 kW)/ 2,0 16V 140 (103 kW)/ 1,5 dCi 90 (66 kW)/ 1,5 dCi 95 (70 kW)/ 1,5 dCi 110 (78/81 kW)/ 1,9 dCi 130 (96 kW)		205/55R16		6½ J x16 H2 5x114,3x66 ET 47
			Kegel sw 17 M12 x 1,5 x 26		€ 78,20
			ASS; CUC; Huf 2.4; Huf 3.4; Huf 3.5; SE1C1; SE1C2; SE2C1; SE2C2; SE1S; SE2S		RDKS

		Z	01/09-12/15	Mégane III / Mégane III CC	
	Coupé, Cabrio		163359	9563	RE 516013
	1,6 16V 110 (81 kW)/ 1,2 TCE 115 (85 kW)/ 1,4 TCE 130 (96 kW)/ 2,0 16V 140 (103 kW)/ 1,5 dCi 110 (78/81 kW)/ 1,9 dCi 130 (96 kW)		205/55R16		6½ J x16 H2 5x114,3x66 ET 47
Mégane III CC Bj.: 07/10-			Kegel sw 17 M12 x 1,5 x 26		€ 78,20
			ASS; CUC; Huf 2.4; Huf 3.4; Huf 3.5; SE1C1; SE1C2; SE2C1; SE2C2; SE1S; SE2S		RDKS

		Z	Mégane III		
			lichtsilber-lackiert		Celsio CS 656 40 5 14
			lichtsilber-lackiert / mattschwarz-lackiert		Tezzo TZ 656 40 5 14
Rad nicht frei für Megane CC		ABE	205/55R16 ❄		6½ J x16 H2 5 x 114,3 ET 40
		ABE	215/50R16 ❄		
CS	TZ	MK 217	Celsio: ASC; ASS; CUC; Huf 2.4; Huf 3.4; Huf 3.5; SE1C1; SE1C2; SE1S; TTC; TTS Tezzo: ASC; ASS; CUC; Huf 2.4; Huf 3.4; Huf 3.5; SE1C1; SE1C2; SE1S; TTC / OE: VDO S180052064Z		RDKS

Mégane III			Z			
MAGNA	Interio		IN 706 45 5 14			
	lichtsilber-lackiert / matschwarz-lackiert					
	7 J x16 EH2+	205/55R16	☼	ABE		
	5 x 114,3	215/50R16	☼	ABE		
ET 45		Rad nicht frei für Megane CC				
RDKS	ASC; CUC; Huf 2.4; Huf 3.4; Huf 3.5; SE1C1; SE1S		MK 217			
		IN			IN	

Mégane IV		01/16-		
Stahl	RE 515035	5020	154618	
	6 J x15 H2			
	5x114,3x66			
ET 35				
€ 70,80				
RDKS	ASC; ASS; CUC; Huf 2.4; Huf 3.4; Huf 3.5; SE1C1; SE1C2; SE2C1; SE2C2; SE1S; SE2S; TTC			
		5-Türer		Radabbildung in Vorbereitung
		Info		

Mégane IV		01/16-		
Stahl	RE 516021	7005	163407	
	6½ J x16 H2			
	5x114,3x66			
ET 41				
€ 78,20				
RDKS	ASC; ASS; CUC; Huf 2.4; Huf 3.4; Huf 3.5; SE1C1; SE1C2; SE2C1; SE2C2; SE1S; SE2S; TTC			
		5-Türer		Radabbildung in Vorbereitung
		Info		

Megane IV				
MAGNA	in Vorbereitung			
RDKS				
		Radabbildung in Vorbereitung		



Mégane Scénic		01/97-08/98		JA	
Stahl	RE 514009	6530	143666	Van	
	5½ J x14 CH	175/70R14		1,6 (55 kW)/1,6e (66 kW)	
	4x100x60				
	ET 36				
€ 60,20		Kegel sw 19 M12 x 1,5 x 25		RE 514009 nicht für Automatik!	
RDKS					
					

		JA	08/99-06/03	Mégane Scénic	
	Van	154566	8175	RE 515015	Stahl
	1,4-16V (70 kW)/1,6/1,6-16V (79 kW)/ 2,0 (80/84 kW)/1,9dT/1,9dT (72 kW)	185/65R15		6 J x15 H2 4x100x60	
	2,0-16V (103 kW)	195/60R15		ET 43	
		Kegel sw 19 M12 x 1,5 x 25		€ 71,30	
RDKS					
		P	09/04-	Modus	
	Mini-Van	154572	7935	RE 515020	Stahl
	1,2i-16V (55 kW)	165/65R15		5½ J x15 H2 4x100x60 ET 43	
		Kegel sw 17 M12 x 1,5 x 26		€ 72,40	
RDKS					
		P	09/04-	Modus	
	Mini-Van	154573	7965	RE 515021	Renner
	1,2i-16V (55 kW)/ 1,2i-16V TCE (74 kW)/ 1,6i-16V (65/82 kW)/ 1,5 dCi (50/63/76 kW)	175/65R15		6 J x15 H2 4x100x60 ET 50	
		185/60R15			
	175/65R15 erst ab Nachtg 10 der ABE zulässig. FZG-Schein beachten. RE 515021 nicht für alle Ausführungen des 1,2i (55 kW) zulässig.	Kegel sw 17 M12 x 1,5 x 26		€ 74,50	
RDKS					
		P	01/08-	Modus (Grand)	
	Mini-Van	154572	7935	RE 515020	Stahl
	1,2i-16V (55 kW)	165/65R15		5½ J x15 H2 4x100x60 ET 43	
		Kegel sw 17 M12 x 1,5 x 26		€ 72,40	
RDKS					
		P	01/08-	Modus (Grand)	
	Mini-Van	154573	7965	RE 515021	Renner
	1,2i-16V (55 kW)/ 1,2i-16V TCE (74 kW)/ 1,6i-16V (65/82 kW)/ 1,5 dCi (50/63/76 kW)	175/65R15		6 J x15 H2 4x100x60 ET 50	
		185/60R15			
		Kegel sw 17 M12 x 1,5 x 26		€ 74,50	
RDKS					

Scénic II			07/03-05/09	JM	
Stahl	RE 515019	8715	154571	Van	
	6½ J x15 H2	195/65R15		1,4i 16V (72 kW)/ 1,6i 16V (83 kW)/ 1,5 dCi (60/74 kW)	
	4x100x60				
	ET 45				
RDKS	€ 70,80	Kegel sw 17 M12 x 1,5 x 26		FZG-Schein beachten. Einige Ausführungen des 1,5 dCi (74 kW) nur 16 Zoll mit 205/60R16.	

Scénic II			07/03-05/09	JM	
Stahl	RE 516010	9985	163355	Van	
	6½ J x16 H2	205/55R16		1,4i 16V (72 kW)/1,6i 16V (83 kW)/1,5 dCi (60/74 kW)	
	4x100x60	205/60R16		2,0-16V(99kW)/2,0T-16V(120 kW)/1,9 dCi (88/96kW)	
	ET 49	205/60R16		Grand Scénic (04/04-)	
RDKS	€ 78,20	Kegel sw 17 M12 x 1,5 x 26		FZG-Schein beachten. Einige Ausführungen des 1,5 dCi (74 kW) nur 205/60R16.	

Scénic III			06/09-05/16	JZ	
Stahl	RE 515026	7305 / 7306	154576	Van	
	6½ J x15 H2	195/65R15		1,6 16V 110 (81 kW)/ 1,5 dCi 110 (78 kW)	
	5x114,3x66				
	ET 43				
RDKS	€ 70,80	Kegel sw 17 M12 x 1,5 x 26			
				ASS; CUC; Huf 2.4; Huf 3.4; Huf 3.5; SE1C1; SE1C2; SE2C1; SE2C2; SE1S; SE2S	

Scénic III			JZ			
Tezzo		TZ 655 45 5 14	lichtsilber-lackiert			
MAGNA	6½ J x15 H2	195/65R15	⊗	ABE		
	5 x 114,3	215/60R15	⊗	ABE		
	ET 45					
RDKS	ASC; ASS; CUC; Huf 2.4; Huf 3.4; Huf 3.5; SE1C1; SE1C2; SE1S; TTC / OE: VDO S180052064Z			MK 217	TZ	TZ

Scénic III			06/09-05/16	JZ	
Stahl	RE 516013	9563	163359	Van	
	6½ J x16 H2	205/60R16		1,2i (85 kW)/ 1,6 16V 110 (81 kW)/ 1,4 TCE 130 (96 kW)/ 2,0 16V 140 (103 kW)/ 1,5 dCi 110 (78 kW)/ 1,9 dCi 130 (96 kW)	
	5x114,3x66				
	ET 47				
RDKS	€ 78,20	Kegel sw 17 M12 x 1,5 x 26			
				ASS; CUC; Huf 2.4; Huf 3.4; Huf 3.5; SE1C1; SE1C2; SE2C1; SE2C2; SE1S; SE2S	

		JZ	06/09-05/16	Scénic (Grand)	
	Van		163359	9563	RE 516013
	1,2i (85 kW)/ 1,6 16V 110 (81 kW)/ 1,4 TCE 130 (96 kW)/ 2,0 16V 140 (103 kW)/ 1,5 dCi 110 (78 kW)/ 1,9 dCi 130 (96 kW)		205/60R16		6½ J x16 H2 5x114,3x66 ET 47
	Grand Scénic nur 16 Zoll!		Kegel sw 17 M12 x 1,5 x 26		€ 78,20
			ASS; CUC; Huf 2.4; Huf 3.4; Huf 3.5; SE1C1; SE1C2; SE2C1; SE2C2; SE1S; SE2S		RDKS

		JZ	Scénic III / Grand Scénic			
			lichtsilber-lackiert	Celsio	CS 656 40 5 14	
			lichtsilber-lackiert / mattschwarz-lackiert	Tezzo	TZ 656 40 5 14	
CS	TZ	Serienbereifung beachten	ABE	205/60R16 ❄	6½ J x16 H2 5 x 114,3 ET 40	
MK 217			Celsio: ASC; ASS; CUC; Huf 2.4; Huf 3.4; Huf 3.5; SE1C1; SE1C2; SE1S; TTC; TTS Tezzo: ASC; ASS; CUC; Huf 2.4; Huf 3.4; Huf 3.5; SE1C1; SE1C2; SE1S; TTC / OE: VDD 5180052064Z		RDKS	

		JZ	Scénic III / Grand Scénic			
			lichtsilber-lackiert / mattschwarz-lackiert	Interio	IN 706 45 5 14	
		Serienbereifung beachten	ABE	205/60R16 ❄	7 J x16 EH2+ 5 x 114,3 ET 45	
IN	IN	MK 217	ASC; CUC; Huf 2.4; Huf 3.4; Huf 3.5; SE1C1; SE1S		RDKS	

		06/16-	Scénic IV		
Radabbildung in Vorbereitung	Van				INFO
	INFO				
			RDKS		

		Scénic IV (Neues Modell ab 2016)			
Radabbildung in Vorbereitung					in Vorbereitung
			RDKS		

Talisman		12/15-			
Stahl	RE 516021	7005	163407	Stufenheck, Kombi	Radabbildung in Vorbereitung
	6½ J x16 H2			INFO	
	5x114,3x66				
	ET 41				
RDKS		ASC; ASS; CUC; Huf 2.4; Huf 3.4; Huf 3.5; SE1C1; SE1C2; SE2C1; SE2C2; SE1S; SE2S; TTC			

Talisman					
Stahl MAGMA	in Vorbereitung				Radabbildung in Vorbereitung
RDKS					

Trafic II		07/01-08/14		FL	
Stahl	RE 616008	9506	163353	Kasten	
	6 J x16 H2	195/65R16		2,0i 16V (88 kW)/1,9 dCi (60/74 kW)/ 2,0 dCi (84 kW)/	
	5x118x71	205/65R16		2,5 dCi (84/99 kW)	
	ET 50	215/65R16			
RDKS		Kegel sw 19 M14 x 1,5 x 30		RE 616008 auch für Opel Vivaro ab 07/01-11/14. FZG-Schein beachten, unterschiedliche Reifen zulässig.	

Trafic II		07/01-08/14		JL	
Stahl	RE 616008	9506	163353	Combi	
	6 J x16 H2	195/65R16		2,0i 16V (88 kW)/1,9 dCi (60/74 kW)/ 2,0 dCi (84 kW)/	
	5x118x71	205/65R16		2,5 dCi (84/99/107 kW)	
	ET 50	215/65R16			
RDKS		Kugel sw 19 M14 x 1,5 x 30		RE 616008 auch für Opel Vivaro ab 07/01- FZG-Schein beachten, unterschiedliche Reifen zulässig. Bei einigen Ausführungen auch 195/75R16 zulässig.	



Trafic III		09/14-		L, JL	
Stahl	RE 616016	7503	163428	Combi, Kasten	
	6 J x16 H2	205/65R16C		dCi 90/115/120/140 (66/84/88/103 kW)	
	5x114,3x66	215/65R16C			
	ET 50				
RDKS		ASC; ASS; CUC; Huf 2.4; Huf 3.4; SE1C1; SE1C2; SE1S; TTC; TTS / OE: Schrader 3041		Typ JL: ab EGBE: e2*98/14*00213*48 Typ L: ab EGBE: e2*2007/46*0014*21	

		C06	07/00-08/07	Twingo	
	Schrägheck	143666	6530	RE 514009	Stahl
	1,2i	155/65R14		5½ J x14 CH 4x100x60 ET 36	
	Eintragung im Fahrzeugschein beachten. Bei manchen Ausführungen ist RE 514009 nicht zulässig!		Kegel sw 19 M12 x 1,5 x 25		
RDKS					

		N	09/07-08/14	Twingo II	
	Schrägheck	143674	7320	RE 514020	Stahl
	1,2i-16V TCE (74 kW)	175/65R14		5½ J x14 H2 4x100x60 ET 29	
			Kegel sw 17 M12 x 1,5 x 26		
RDKS					



		N	09/07-08/14	Twingo II	
	Schrägheck	143674	7320	RE 514020	Stahl
	1,2i (43 kW)	165/65R14		5½ J x14 H2	
	1,2i-16V (56 kW)/ 1,5 dCi (47 kW)	165/65R14		4x100x60	
		175/65R14		ET 29	
			Kegel sw 17 M12 x 1,5 x 26		
RDKS					



		N	Twingo II		
		lichtsilber-lackiert	Celsio	CS 554 35 4 00	
	Bereifung 165/65R14 nur wenn Serie	ABE	165/65R14 *	5½ J x14 H2 4 x 100 ET 35	MAGMA
		ABE	175/65R14 *		
CS	MK 216	ASC; ASS; Huf 2.4; Huf 3.4; SE1C1; SE1C2; SE1S; TTC; TTS			
RDKS					

		N	Twingo II			
		lichtsilber-lackiert / mattschwarz-lackiert		Interio	IN 604 38 4 00	
		Bereifung 165/65R14 nur wenn Serie	ABE	165/65R14 *	6 J x14 H2 4 x 100 ET 38	MAGMA
			ABE	175/65R14 *		
IN	MK 216	ASC; ASS; Huf 2.4; Huf 3.4; SE1C1; SE1C2; SE1S; TTC; TTS				
RDKS						

Twingo III			09/14-	AH	
Stahl	RE 515032	4001	154606	Schrägheck	Radabbildung in Vorbereitung
	5 J x15 H2	165/65R15		SCe 70 (52 kW)/TCe 90 (66 kW)	
	4x100x60				
	ET 38				
	€ 68,90			Nur für die Vorderachse zulässig!	
RDKS	ASC; ASS; Huf 2.4; Huf 3.4; SE1C1; SE1C2; SE1S; TTC; TTS / OE: Schrader 3041				

Twingo III			09/14-	AH	
Stahl	RE 515033	4002	154607	Schrägheck	Radabbildung in Vorbereitung
	5½ J x15 H2	185/60R15		SCe 70 (52 kW)/TCe 90 (66 kW)	
	4x100x60				
	ET 36				
	€ 69,90			Nur für die Hinterachse zulässig!	
RDKS	ASC; ASS; CUC; CUS; Huf 2.4; Huf 3.4; SE1C1; SE1C2; SE1S; TTC; TTS / OE: Schrader 3041				

Twingo III				AH	
MAGNA	Interio	IN 605 38 4 00	lichtsilber-lackiert / mattschwarz-lackiert		
	6 J x15 H2	165/65R15	ABE	Vorderachse: 165/65R15	
	4 x 100	185/60R15	ABE	Hinterachse: 185/60R15	
	ET 38				
RDKS	ASC; ASS; CUS; Huf 2.4; Huf 3.4; SE1C1; SE1C2; SE1S; TTC; TTS			MK 216	
					

Wind				N	
MAGNA	Interio	IN 706 45 4 00	lichtsilber-lackiert / mattschwarz-lackiert		
	7 J x16 EH2+	195/45R16	ABE		
	4 x 100	205/45R16	ABE		
	ET 45	215/45R16	ABE		
RDKS	ASC; CUC; Huf 2.4; Huf 3.4; Huf 3.5; SE1C1; SE1S			MK 216	



		YS3FXXXX	09/02-12/11	9-3	
	Stufenheck, Kombi	163330	9455	SA 516002	Stahl
	1,8i (90 kW)/ 1,8T (110 kW)/ 2,0T(129/154 kW)/ 1,9 TiD (88/110/132 kW)/ 2,2 TiD (92 kW)	205/55R16 M+S 215/55R16		6½ J x16 H2 5x110x65 ET 41	
	FZG-Schein beachten! Reifengröße je nach Fahrzeugausführung. Einige Ausführungen nur 15 Zoll. M+S Einschränkungen je nach Fahrzeugausführung.	Kegel sw 17 M12 x 1,5 x 22		€ 81,40	RDKS

		YS3FX7XX	09/03-12/11	9-3 Cabrio	
	Cabrio	163330	9455	SA 516002	Stahl
	1,8T (110 kW)/ 2,0T (129 kW)/ 2,0T (154 kW)	205/55R16 M+S 215/55R16		6½ J x16 H2 5x110x65 ET 41	
		Kegel sw 17 M12 x 1,5 x 22		€ 81,40	RDKS

		YS3E	09/97-06/10	9-5	
	Stufenheck, Kombi	154680	8625	*SA 515001	Stahl
	2,0t/2,3t/3,0 V6t	205/65R15 195/65R15 M+S		6 J x15 H2 5x110x65 ET 49	
		Kegel sw 17 M12 x 1,5 x 22		€ 74,50	RDKS

		7MS	05/01-09/10	Alhambra I	
	Van	163801		VO 516010	Stahl
	1,8T (110 kW)/ 2,0i (85 kW)/2,8 V6 (150 kW)/ 1,9TDI PD (66/85/96/110 kW)	195/60R16 205/55R16 215/55R16		6 J x16 H2 5x112x57 ET 53	
	(2,8 V6 nicht 205/55R16 / 195/60R16 nur M+S)	Kugel sw 19 M14 x 1,5 x 34		€ 79,70	
	FZG-Schein beachten. Je nach Ausführung unterschiedliche Reifenabmessungen zulässig. Nur für Fahrzeuge mit 16 Zoll Bremsanlage. Einige Ausführungen 195/60R16 nur M+S bzw. Reinforced.				RDKS

Alhambra II		10/10-	7N	
Renner	VO 516031		165303	Van
	6½ J x16 H2	205/60R16		1,4i (110 kW)/ 2,0i (147 kW)/ 2,0TDI (85/100/103/125/130 kW)/
	5x112x57	215/60R16		4WD
	ET 33			
	€ 84,50	Kugel sw 17 M14 x 1,5 x 27		
RDKS	ASC; ASS; CUC; Huf 2.4; Huf 3.4; Huf 3.5; SE1C1; SE1C2; SE2C1; SE2C2; SE1S; SE2S			

Alhambra II		7N			
MAGNUM	Celsio	CS 706 38 5 12	lichtsilber-lackiert		
	Interio	IN 706 38 5 12	lichtsilber-lackiert / mattschwarz-lackiert		
	7 J x16 EH2+	205/60R16 ❄	ABE	Achtung / Bremsanlage beachten	
	5 x 112	215/60R16 ❄	ABE		
	ET 38	225/55R16 ❄	ABE		
RDKS	Celsio: ASC; CUC; Huf 3.4; Huf 3.5; SE1C1; SE1S Interio: ASC; CUC; Huf 2.4; Huf 3.4; Huf 3.5; SE1C1; SE1S		MK 306	CS 	IN 

Altea / Altea XL		10/08-	5P	
Renner	VO 515024	9165	154104	Mini-Van
	6 J x15 H2	195/65R15		1,2 TSI (77 kW)/ 1,4i (63 kW)/ 1,4 TSI (92 kW)/ 1,6i-16V (75 kW)/
	5x112x57			1,8 TSI (118 kW)/ 2,0 FSI (110 kW)/ 1,6 TDI CR (77 kW)/
	ET 47			1,9 TDI (77 kW)/ 2,0 TDI (103 kW)/ 1,6 LPG (75 kW)
	€ 63,90	Kugel sw 17 M14 x 1,5 x 27		15" nur zulässig ab EGNE-Nachtrag: *24.
RDKS	CUC; SE1C1; SE2C1; SE1S; SE2S			FZG-Unterlagen beachten, je nach Ausführung nur 16" zulässig!

Altea / Altea XL		06/04-	5P	
Renner	VO 516015	9915	163902	Mini-Van
	6½ J x16 H2	205/55R16		1,2 TSI (77 kW)/ 1,4i (63 kW)/ 1,4 TSI (92 kW)/ 1,6i-16V (75 kW)/
	5x112x57			1,8 TSI/FSI (118 kW)/ 2,0 FSI (110 kW)/ 1,6 TDI CR (77 kW)/
	ET 50			1,9 TDI (77 kW)/ 2,0 TDI (103 kW)/ 1,6 LPG (75 kW)
	€ 75,00	Kugel sw 17 M14 x 1,5 x 27		
RDKS	ASC; ASS; CUC; Huf 2.4; Huf 3.4; Huf 3.5; SE1C1; SE1C2; SE2C1; SE2C2; SE1S; SE2S			

Altea Freetrack		09/07-	5P	
Renner	VO 516015	9915	163902	Mini-Van
	6½ J x16 H2	205/60R16 M+S		2,0 TFSI (147/155 kW)/ 2,0 TDI (103/125 kW/ 4x2/ 4x4
	5x112x57	205/55R16		
	ET 50			
	€ 75,00	Kugel sw 17 M14 x 1,5 x 27		Fahrzeugunterlagen beachten: Je nach Ausführung unterschiedliche Reifenabmessungen zulässig!
RDKS	ASC; ASS; CUC; Huf 2.4; Huf 3.4; Huf 3.5; SE1C1; SE1C2; SE2C1; SE2C2; SE1S; SE2S			

		5P, 5PN	Altea / Altea XL / Altea Freetrack					
	CS		lichtsilber-lackiert	Celsio	CS 656 50 5 12	MAGNA		
				lichtsilber-lackiert / mattschwarz-lackiert	Tezzo		TZ 656 50 5 12	
				Bereifung 195/60R16 nicht für Altea Freetrack	ABE		195/60R16 ❄	6½ J x16 H2
					ABE		205/55R16 M+S ❄	5 x 112
		MK 306	Celsio: ASC; ASS; CUC; Huf 2.4; Huf 3.4; Huf 3.5; SE1C1; SE1C2; SE15; TTC; TTS Tezzo: ASC; ASS; CUC; Huf 2.4; Huf 3.4; Huf 3.5; SE1C1; SE1C2; SE15; TTC			RDKS		



		6H, 6HS	06/97-03/05	Arosa	
	Schrägheck 1,0i/ 1,4i/1,4 TDI/ 1,7 SDI	132903	4645	VO 513015	Stahl
		175/65R13		5½ J x13 H2 4x100x57 ET 43	
		Kugel sw 17 M12 x 1,5 x 23,5		€ 50,20	
				RDKS	

		6L	01/03-	Cordoba	
	Stufenheck 1,2-12V (47 kW)/ 1,4-16V(55 kW)/ 1,9 SDI (47 kW)	143502	5210	VO 514015	Renner
		165/70R14		5 J x14 H2 5x100x57 ET 35	
		Kugel sw 17 M14 x 1,5 x 27		€ 56,00	
Die Radkappen vom 6 x 14 Rad können nicht verbaut werden!		SE15		RDKS	

		6L	01/03-	Cordoba	
	Stufenheck 1,2-12V (47 kW)/ 1,4-16V (55/74 kW)/ 1,9 SDI (47 kW)/ 1,9 TDi (74 kW)	143402	7280	VO 514016	Stahl
		185/60R14		6 J x14 H2 5x100x57 ET 43	
		Kugel sw 17 M14 x 1,5 x 27		€ 58,10	
Die Radkappen vom 5 x 14 Rad können nicht verbaut werden!				RDKS	

		6L	01/03-	Cordoba	
	Stufenheck 1,2-12V (47 kW)/ 1,4-16V (55/74 kW)/ 1,9 SDI (47 kW)/ 1,9 TDi (74/96 kW)	152506	9545	VO 515020	Stahl
		185/55R15 M+S		6 J x15 H2 5x100x57 ET 43	
		Kugel sw 17 M14 x 1,5 x 27		€ 64,50	
FZG-Schein beachten: Je nach Ausführung nur 195/50 R15 oder 195/55 R15 zulässig.				RDKS	

Exeo / Exeo ST		03/09-	3R, 3RN	
Renner	VO 516029	9257	163307	Stufenheck, Kombi 1,6i (72/75 kW)/ 1,8T (110 kW)/ 1,8 TSI (88/118 kW)/ 2,0TSI (147 kW)/ 2,0 TDI CR (88/105/125 kW)
	7 J x16 H2	205/55R16		
	5x112x57			
	ET 45			
	€ 78,20	Kugel sw 17 M14 x 1,5 x 27		Typ 3R auch 195/60R15 sofern eingetragen.
RDKS	ASS; CUC; Huf 3.5; SE1C1; SE2C1; SE2C2			

Exeo / Exeo ST		3R, 3RN				
MAGNA	Celsio	CS 706 38 5 12	lichtsilber-lackiert			
	Interio	IN 706 38 5 12	lichtsilber-lackiert / mattschwarz-lackiert			
	7 J x16 EH2+	205/55R16 ❄	ABE			
	5 x 112					
	ET 38					
RDKS	Celsio: ASC; CUC; Huf 3.4; Huf 3.5; SE1C1; SE1S Interio: ASC; CUC; Huf 2.4; Huf 3.4; Huf 3.5; SE1C1; SE1S		MK 306	CS	IN	

Ibiza		04/02-06/08	6L	
Renner	VO 514015	5210	143502	Schrägheck 1,2i (47kW)/1,4i (55 kW)/1,9 SDi (47kW)
	5 J x14 H2	165/70R14		
	5x100x57			
	ET 35			
	€ 56,00	Kugel sw 17 M14 x 1,5 x 27		Die Radkappen vom 6 x 14 Rad können nicht verbaut werden! Radkappe mit der OE-Nummer: 6Q0 601 147 M verwenden.
RDKS				

Ibiza		04/02-06/08	6L	
Stahl	VO 514016	7280	143402	Schrägheck 1,2 (47kW)/1,4 (55/74kW)/1,9 SDi (47kW)/ 1,9 TDi (74kW)
	6 J x14 H2	185/60R14		
	5x100x57			
	ET 43			
	€ 58,10	Kugel sw 17 M14 x 1,5 x 27		Die Radkappen vom 5 x 14 Rad können nicht verbaut werden! Radkappe mit der OE-Nummer: 6Q0 601 147 L verwenden.
RDKS				

Ibiza		04/02-06/08	6L	
Stahl	VO 515020	9545	152506	Schrägheck 1,2 (47kW)/1,4 (55/74kW)/1,8 T FR (110 kW)/1,9 SDi (47kW)/ 1,9 TDi (74kW/96kW)
	6 J x15 H2	185/55R15 M+S		
	5x100x57	195/50R15		
	ET 43	195/55R15		
	€ 64,50	Kugel sw 17 M14 x 1,5 x 27		1,2i (47kW) nur 195/55R15 zulässig. 1,8 T (110 kW) nicht 195/50R15. Je nach Ausführung unterschiedliche Reifenabmessungen zulässig! OE-Radkappe: 6Q0 601 147 N
RDKS				

		6L	07/08-03/09	Ibiza „Best of“	
	Schrägheck	143502	5210	VO 514015	
	1,2 12V (51 kW)/ 1,4 16V (63 kW)/ 1,4 TDI (59 kW)	165/70R14		5 J x14 H2 5x100x57 ET 35	
	FZG-Schein beachten: Je nach Ausführung unterschiedliche Rad-/Reifenkombinationen zulässig! Baureihe wird parallel zum neuen Ibiza (Typ: 6J) weitergebaut.	Kugel sw 17 M14 x 1,5 x 27		€ 56,00	
RDKS					

Renner

		6L	07/08-03/09	Ibiza „Best of“	
	Schrägheck	143402	7280	VO 514016	
	1,2 12V (51 kW)/ 1,4 16V (63 kW)/ 1,4 TDI (51/59 kW)	185/60R14		6 J x14 H2 5x100x57 ET 43	
	FZG-Schein beachten: Je nach Ausführung unterschiedliche Rad-/Reifenkombinationen zulässig! Baureihe wird parallel zum neuen Ibiza (Typ: 6J) weitergebaut.	Kugel sw 17 M14 x 1,5 x 27		€ 58,10	
RDKS					

Stahl

		6L	07/08-03/09	Ibiza „Best of“	
	Schrägheck	152506	9545	VO 515020	
	1,2 12V (51 kW)/ 1,4 16V (63 kW)/ 1,4 TDI (51/59 kW)	185/55R15 M+S 195/50R15 195/55R15		6 J x15 H2 5x100x57 ET 43	
	FZG-Schein beachten: Je nach Ausführung unterschiedliche Rad-/Reifenkombinationen zulässig! Baureihe wird parallel zum neuen Ibiza (Typ: 6J) weitergebaut.	Kugel sw 17 M14 x 1,5 x 27		€ 64,50	
RDKS					



Stahl

		6J, 6JN	07/08-	Ibiza / Ibiza SC / ST	
	Schrägheck, Kombi	143502	5210	VO 514015	
	1,0i (55 kW)/ 1,2i (44/55/66 kW)/ 1,4i (63 kW)/ 1,6i (77 kW)/ 1,2 TDI (55 kW)/ 1,4 TDI (55/59 kW)/ 1,6 TDI (66 kW)/ 1,9 TDI (66/77 kW)/ 1,6 LPG (60 kW)	175/70R14		5 J x14 H2 5x100x57 ET 35	
	Typ 6JN: 59 kW Einige Ausführungen des 1,4 TDI (59 kW) auch 165/70R14 Einige Ausführungen nur 15 Zoll.	Kugel sw 17 M14 x 1,5 x 27		€ 56,00	
		SE1S		RDKS	



Renner



		6J, 6JN	Ibiza / Ibiza SC / Ibiza ST		
		lichtsilber-lackiert	Celsio	CS 554 38 5 00	
			ABE	175/65R14 ❄	5½ J x14 H2 5 x 100 ET 38
			ABE	175/70R14 ❄	
	CS	MK 303	ASC; ASS; Huf 2.4; Huf 3.4; SE1C1; SE1C2; SE1S; TTC; TTS		

KRONPRINZ
MAGMA







Ibiza / Ibiza SC / Ibiza ST				6J, 6JN			
MAGNA	Interio		IN 604 38 5 00		lichtsilber-lackiert / mattschwarz-lackiert		
	6 J x14 H2	175/65R14 *	ABE				
	5 x 100	175/70R14	ABE				
	ET 38						
RDKS	ASC; ASS; Huf 2.4; Huf 3.4; SE1C1; SE1C2; SE1S; TTC; TTS			MK 303		IN	IN

Ibiza / Ibiza SC / ST			07/08-	6J, 6JN		
Renner	VO 515030	7760	154105	Schrägheck, Kombi		
	6 J x15 H2	185/60R15		1,0i (55/70/81 kW) / 1,2i (44/51/66/77 kW) / 1,4i (63/110/132 kW) / 1,6i (77 kW) / 1,2 TDI (55 kW) / 1,4 TDI (55/59/66/77 kW) / 1,6 TDI (66/77 kW) / 1,9 TDI (66/77 kW) / 2,0 TDI (105 kW) / 1,6 LPG		
	5x100x57					
	ET 38					
	€ 64,50	Kugel sw 17 M14 x 1,5 x 27		Einige Ausführungen auch 175/65R15 zulässig. 6JN: 44-77 kW		
RDKS	CUC; SE1C1; SE1C2; SE2C1; SE1S; SE2S					

Ibiza / Ibiza SC / Ibiza ST				6J, 6JN			
MAGNA	Interio		IN 605 35 5 00		lichtsilber-lackiert / mattschwarz-lackiert		
	6 J x15 H2	185/55R15 *	ABE				
	5 x 100	185/60R15	ABE				
	ET 35						
RDKS	ASC; ASS; CUS; Huf 2.4; Huf 3.4; SE1C1; SE1C2; SE1S; TTC; TTS			MK 303		IN	IN

Ibiza / Ibiza SC / Ibiza ST				6J, 6JN				
MAGNA	Celsio		CS 655 35 5 00		lichtsilber-lackiert			
	Tezzo		TZ 655 35 5 00					lichtsilber-lackiert / mattschwarz-lackiert
	6½ J x15 H2	185/55R15 *	ABE					
	5 x 100	185/60R15	ABE					
ET 35								
RDKS	Celsio: ASC; ASS; CUC; Huf 2.4; Huf 3.4; Huf 3.5; SE1C1; SE1C2; SE1S; TTC; TTS Tezzo: ASC; ASS; CUC; Huf 2.4; Huf 3.4; Huf 3.5; SE1C1; SE1C2; SE1S; TTC			MK 303		CS	TZ	

Leon			12/99-08/05	1M		
Stahl	VO 515011	8380	152503	Schrägheck		
	6 J x15 H2	195/65R15		1,4i/1,6i/1,8i (92 kW)/1,9 TDI (66/81/110 kW)		
	5x100x57					
	ET 38					
	€ 64,50	Kugel sw 17 M14 x 1,5 x 27		Auch für Leon 4 (Allrad) zulässig. FZG-Schein beachten. Nicht für alle Ausführungen zulässig. M+S Auflagen beachten.		
RDKS						



		1M	12/99-08/05	Leon	
	Schrägheck	162701	9680	VO 516005	Stahl
	1,4 16V (55 kW)/ 1,6 16V (77 kW)/ 1,8T (132 kW) 1,9TDi (81/110 kW)	205/55R16		6½ J x16 H2 5x100x57 ET 42	
Auch für Leon 4 (Allrad) zulässig. FZG-Schein beachten. Nicht für alle Ausführungen zulässig. M+S Auflagen beachten.		Kugel sw 17 M14 x 1,5 x 27		€ 82,40	RDKS
		1P	10/08-11/12	Leon	
	Schrägheck	154104	9165	VO 515024	Renner
	1,2 TSI (77 kW)/ 1,4i (63 kW)/ 1,4 TSI (92 kW)/ 1,6i (75 kW)/ 1,8 FSI (118 kW)/ 2,0 FSI (110 kW)/ 1,6 TDI (77 kW)/ 1,9 TDI (66/77 kW)/ 2,0 TDI (103 kW)/ 1,6 LPG (75 kW)	195/65R15		6 J x15 H2 5x112x57 ET 47	
15 Zoll erst ab EGBE-Nachtrag *17 zulässig!		Kugel sw 17 M14 x 1,5 x 27		€ 63,90	RDKS
		1P	09/05-11/12	Leon / Leon FR	
	Schrägheck	164001	9535	AD 516012	Renner
	1,2 TSI/ 1,4i (63 kW)/ 1,4 TSI (92 kW)/ 1,6i (75 kW)/ 1,8 FSI (118 kW)/ 2,0 FSI (110 kW)/ 2,0 TFSI (147 kW)/ 2,0 TFSI FR (155 kW)/ 1,6 TDI/ 1,9 TDI/ 2,0 TDI (103/125 kW)/ 1,6 LPG	205/55R16		6 J x16 H2 5x112x57 ET 50	
AD 516012 bei 2,0 TDI FR (125 kW) erst ab EGBE-Nachtrag *21 zulässig! 2,0 TFSI (147 kW) und 2,0 TFSI FR (155 kW) nur 205/55R16 M&S! Nicht zulässig für Cupra (177 kW) und Cupra R (195 kW)		Kugel sw 17 M14 x 1,5 x 27		€ 74,50	RDKS
		1P	09/05-11/12	Leon / Leon FR	
	Schrägheck	163902	9915	VO 516015	Renner
	1,2 TSI/ 1,4i (63 kW)/ 1,4 TSI (92 kW)/ 1,6i (75 kW)/ 1,8 FSI (118 kW)/ 2,0 FSI (110 kW)/ 2,0 TFSI (147 kW)/ 2,0 TFSI FR (155 kW)/ 1,6 TDI/ 1,9 TDI/ 2,0 TDI (103/125 kW)/ 1,6 LPG	205/55R16		6½ J x16 H2 5x112x57 ET 50	
2,0 TFSI (147 kW) und 2,0 TFSI FR (155 kW) nur 205/55R16 M&S! Nicht zulässig für Cupra (177 kW) und Cupra R (195 kW)		Kugel sw 17 M14 x 1,5 x 27		€ 75,00	RDKS
		1P, 1PN	Leon / Leon FR		
		lichtsilber-lackiert	Celsio	CS 656 50 5 12	
		lichtsilber-lackiert / mattschwarz-lackiert	Tezzo	TZ 656 50 5 12	
		ABE	205/55R16	6½ J x16 H2	MAGNA
				5 x 112 ET 50	
CS		MK 306		Celsio: ASC; ASS; CUC; Huf 2.4; Huf 3.4; Huf 3.5; SE1C1; SE1C2; SE1S; TTC; TTS Tezzo: ASC; ASS; CUC; Huf 2.4; Huf 3.4; Huf 3.5; SE1C1; SE1C2; SE1S; TTC	RDKS







Leon		12/12-	5F	
Renner	VO 515031	7755	155801	Schrägheck
	6 J x15 H2	195/65R15		1,2 TSI (63/77/81 kW)/ 1,4 TSI (90/92/103/110 kW)/ 1,6 TDI (66/77/81 kW)/ 2,0 TDI (110 kW)/ 1,4 TGI (81 kW)
	5x112x57			
	ET 43			
	€ 67,10	Kugel sw 17 M14 x 1,5 x 27		Nicht in Verbindung mit ECOMOTIVE.
RDKS	ASC; ASS; CUC; Huf 3.5; SE1C1; SE1C2; SE2C1; SE1S; SE2S			

Leon		12/12-	5F	
Renner	VO 516034	8247	165601	Schrägheck
	6 J x16 H2	205/55R16		1,0 TSI (85 kW)/ 1,2 TSI (63/77/81 kW)/ 1,4 TSI (90/92/103/110 kW)/ 1,8 TSI (132 kW)/ 1,6 TDI (66/77/81 kW)/ 2,0 TDI (110/135 kW)/ 1,4 TGI (81 kW)
	5x112x57			
	ET 48			
	€ 78,20	Kugel sw 17 M14 x 1,5 x 27		
RDKS	ASC; CUC; Huf 2.4; Huf 3.4; Huf 3.5; SE1C1; SE1C2; SE2C1; SE2C2; SE1S; SE2S			

Leon		12/12-	5F	
Renner	VO 516035	8667	165305	Schrägheck
	6½ J x16 H2	205/55R16		1,0 TSI (85 kW)/ 1,2 TSI (63/77/81 kW)/ 1,4 TSI (90/92/103/110 kW)/ 1,8 TSI (132 kW)/ 1,6 TDI (66/77/81 kW)/ 2,0 TDI (110/135 kW)/ 1,4 TGI (81 kW)
	5x112x57			
	ET 46			
	€ 78,50	Kugel sw 17 M14 x 1,5 x 27		
RDKS	ASC; ASS; CUC; Huf 2.4; Huf 3.4; Huf 3.5; SE1C1; SE1C2; SE2C1; SE2C2; SE1S; SE2S			

Leon / Leon ST			5F		
MAGNA	Celsio	CS 656 50 5 12	lichtsilber-lackiert		
	Tezzo	TZ 656 50 5 12	lichtsilber-lackiert / mattschwarz-lackiert		
	6½ J x16 H2	205/55R16	ABE		
	5 x 112				
	ET 50				
RDKS	Celsio: ASC; ASS; CUC; Huf 2.4; Huf 3.4; Huf 3.5; SE1C1; SE1C2; SE1S; TTC; TT5 Tezzo: ASC; ASS; CUC; Huf 2.4; Huf 3.4; Huf 3.5; SE1C1; SE1C2; SE1S; TTC		MK 306	CS	TZ

Leon / Leon ST			5F		
MAGNA	Interio	IN 706 45 5 12	lichtsilber-lackiert / mattschwarz-lackiert		
	7 J x16 EH2+	205/55R16	ABE		
	5 x 112				
	ET 45				
RDKS	ASC; CUC; Huf 2.4; Huf 3.4; Huf 3.5; SE1C1; SE1S		MK 306	IN	IN

		5F	Leon / Leon ST	
 <p>TZ</p>	 <p>TZ</p>	lichtsilber-lackiert / mattschwarz-lackiert		Tezzo
				TZ 757 50 5 12
		ABE	205/45R17	7½ J x17 H2
		ABE	215/45R17	5 x 112
		ABE	225/45R17	ET 50
MK 306		ASC; ASS; CUC; Huf 2.4; Huf 3.4; Huf 3.5; SE1C1; SE1C2; SE1S		
RDKS				
		5F	12/13-	Leon ST
	Kombi	155801	7755	VO 515031
	1,2 TSI (63/77/81 kW)/ 1,4 TSI (90/92/103/110 kW)/ 1,6 TDI (66/77/81 kW)/ 2,0 TDI (110 kW)/ 1,4 TGI (81 kW)	195/65R15		6 J x15 H2
				5x112x57
				ET 43
Nicht in Verbindung mit ECOMOTIVE.		Kugel sw 17 M14 x 1,5 x 27		€ 67,10
		ASC; ASS; CUC; Huf 3.5; SE1C1; SE1C2; SE2C1; SE1S; SE2S		
RDKS				
		5F	12/13-	Leon ST
	Kombi	165601	8247	VO 516034
	1,0 TSI (85 kW)/ 1,2 TSI (63/77/81 kW)/ 1,4 TSI (90/92/103/110 kW)/ 1,8 TSI (132 kW)/ 1,6 TDI (66/77/81 kW)/ 2,0 TDI (110/135 kW)/ 1,4 TGI (81 kW)	205/55R16		6 J x16 H2
				5x112x57
				ET 48
		Kugel sw 17 M14 x 1,5 x 27		€ 78,20
		ASS; CUC; Huf 2.4; Huf 3.4; Huf 3.5; SE1C1; SE1C2; SE2C1; SE2C2; SE1S; SE2S		
RDKS				
		5F	12/13-	Leon ST
	Kombi	165305	8667	VO 516035
	1,0 TSI (85 kW)/ 1,2 TSI (63/77/81 kW)/ 1,4 TSI (90/92/103/110 kW)/ 1,8 TSI (132 kW)/ 1,6 TDI (66/77/81 kW)/ 2,0 TDI (110/135 kW)/ 1,4 TGI (81 kW)	205/55R16		6½ J x16 H2
				5x112x57
				ET 46
		Kugel sw 17 M14 x 1,5 x 27		€ 78,50
		ASC; ASS; CUC; Huf 2.4; Huf 3.4; Huf 3.5; SE1C1; SE1C2; SE2C1; SE2C2; SE1S; SE2S		
RDKS				
		AA	04/12-	Mii
	Steilheck	143629	6795	VO 514021
	1,0i (44/55 kW)	165/70R14		5 J x14 H2
		175/65R14		4x100x57
				ET 35
Baugleich VW Up und Skoda Citigo.				€ 56,80
		ASC; CUC; Huf 2.4; Huf 3.4; Huf 3.5; SE1C1; SE2C1; SE2C2; SE1S; SE2S		
RDKS				

KRONPRINZ
MAGNA

Renner

Renner

Renner

Renner

Mii			AA	
MAGNA	Celsio		CS 554 35 4 00	lichtsilber-lackiert
	5½ J x14 H2	165/70R14	ABE	
	4 x 100	175/65R14	ABE	
	ET 35	185/60R14	ABE	
RDKS	ASC; ASS; Huf2.4; Huf 3.4; SE1C1; SE1C2; SE1S; TTC; TTS			MK 205



CS

„20V20“			2016-	
Stahl	INFO		SUV	
			INFO	
RDKS				

Radabbildung
in
Vorbereitung

„20V20“				
MAGNA	in Vorbereitung			
RDKS				

Radabbildung
in
Vorbereitung



Toledo		04/99-11/04		1M	
Stahl	VO 515011	8380	152503	Schrägheck	
	6 J x15 H2	195/65R15		1,6i (74/77 kW)/1,8i (92 kW)/1,8T (110/132 kW)/	
	5x100x57			1,9TDI (66/81/96/110 kW)	
	ET 38				
RDKS	€ 64,50	Kugel sw 17 M14 x 1,5 x 27		FZG-Schein beachten. Nicht für alle Ausführungen zulässig. M+S Auflagen beachten.	





Toledo		04/99-11/04		1M	
Stahl	VO 516005	9680	162701	Schrägheck	
	6½ J x16 H2	205/55R16		1,6i 16V (77 kW)/ 1,8 20V (132 kW)/	
	5x100x57			2,3 V5 (110/125 kW)/ 1,9 TDi /81/96/110 kW)	
	ET 42				
RDKS	€ 82,40	Kugel sw 17 M14 x 1,5 x 27		FZG-Schein beachten. Nicht für alle Ausführungen zulässig. M+S Auflagen beachten.	





		5P	12/04-10/12	Toledo	
	Mini-Van	163902	9915	VO 516015	Renner
	1,6i-16V (75 kW)/ 2,0 FSI (110 kW)/ 1,9 TDI (77 kW)/ 2,0 TDI (103 kW)	205/55R16		6½ J x16 H2 5x112x57 ET 50	
		Kugel sw 17 M14 x 1,5 x 27		€ 75,00	RDKS

		5P, 5PN	Toledo		
		lichtsilber-lackiert	Celsio	CS 656 50 5 12	
		lichtsilber-lackiert / mattschwarz-lackiert	Tezzo	TZ 656 50 5 12	
		ABE	205/55R16 M+S ❄	6½ J x16 H2 5 x 112 ET 50	MAGMA
		MK 306		Celsio: ASC; ASS; CUC; Huf 2.4; Huf 3.4; Huf 3.5; SE1C1; SE1C2; SE15; TTC; TTS Tezzo: ASC; ASS; CUC; Huf 2.4; Huf 3.4; Huf 3.5; SE1C1; SE1C2; SE15; TTC	
					RDKS

		NH	11/12-	Toledo	
	Stufenheck	143502	5210	VO 514015	Renner
	1,2i (55kW)/ 1,2 TSI (63 kW)	175/70R14		5 J x14 H2 5x100x57 ET 35	
			Kugel sw 17 M14 x 1,5 x 27		
		SE1S			RDKS

		NH	11/12-	Toledo	
	Stufenheck	154105	7760	VO 515030	Renner
	1,2i (55 kW)/ 1,2 TSI (63/77 kW)/ 1,4 TSI (90 kW)/ 1,6 TDI (77 kW)	185/60R15		6 J x15 H2	
	1,2 TSI (77 kW)/ 1,4 TSI (90 kW)/ 1,6 TDI (77 kW)	195/55R15		5x100x57 ET 38	
	Je nach Ausführung unterschiedliche Reifenabmessungen zulässig!	Kugel sw 17 M14 x 1,5 x 27		€ 64,50	
		CUC; SE1C1; SE1C2; SE2C1; SE15; SE2S			RDKS

		NH	Toledo		
		lichtsilber-lackiert / mattschwarz-lackiert	Interio	IN 605 35 5 00	
		ABE	185/60R15	6 J x15 H2	MAGMA
		ABE	195/55R15	5 x 100 ET 35	
		MK 303		ASC; ASS; CUS; Huf 2.4; Huf 3.4; SE1C1; SE1C2; SE15; TTC; TTS	
					RDKS

Citigo		06/12-	AA	
Renner	VO 514021	6795	143629	Steilheck
	5 J x14 H2	165/70R14		1,0i (44/55 kW)
	4x100x57	175/65R14		
	ET 35			
	€ 56,80	Kugel sw 17 M12 x 1,5 x 26		Baugleich VW Up und Seat Mii.
RDKS	ASC; CUC; Huf 2.4; Huf 3.4; Huf 3.5; SE1C1; SE2C1; SE2C2; SE1S; SE2S			



Citigo		AA	
MAGMA	Celsio	CS 554 35 4 00	lichtsilber-lackiert
	5½ J x14 H2	165/70R14	ABE
	4 x 100	175/65R14	ABE
	ET 35	185/60R14	ABE
RDKS	ASC; ASS; Huf 2.4; Huf 3.4; SE1C1; SE1C2; SE1S; TTC; TTS		MK 205



CS

Fabia		01/00-04/07	6Y	
Renner	VO 514015	5210	143502	Schräg-/Stufenheck, Combi
	5 J x14 H2	165/70R14		1,0i (37 kW)/ 1,2i (40 kW)/ 1,2i-12V (47 kW)/
	5x100x57			1,4i (44/50 kW)/ 1,4i-16V (55/74 kW)/
	ET 35			1,4 TDI-PD (55 kW)/ 1,9 SDI (47 kW)
	€ 56,00	Kugel sw 17 M14 x 1,5 x 27		Die Radkappen vom 6 x 14 Rad können nicht verbaut werden! Radkappe mit der OE-Nummer: 6Y0 601 147 A verwenden. Nicht zulässig für Combi 1,4-16V (74 kW)!
RDKS				





Fabia		01/00-04/07	6Y	
Stahl	VO 514016	7280	143402	Schräg-/Stufenheck, Combi
	6 J x14 H2	185/60R14		1,0i (37 kW)/ 1,2i (40 kW)/ 1,2i-12V (47 kW)/
	5x100x57			1,4i (44/50 kW)/ 1,4i-16V (55/74 kW)/ 1,4 TDI-PD (55 kW)/
	ET 43			1,9 SDI (47 kW)/ 1,9 TDI-PD (74 kW)
	€ 58,10	Kugel sw 17 M14 x 1,5 x 27		Die Radkappen vom 5 x 14 Rad können nicht verbaut werden! Radkappe mit der OE-Nummer: 6Y0 601 147 C verwenden.
RDKS				





Fabia		01/00-04/07	6Y	
Renner	VO 515025	8000	152507	Schräg-/Stufenheck, Combi
	6 J x15 H2	185/55R15		1,0i/ 1,2i/ 1,2i-12V/ 1,4i/ 1,4i-16V/ 2,0i (85 kW)/
	5x100x57	195/50R15		1,4 TDI-PD/1,9 SDI/ 1,9 TDI-PD (74 kW)
	ET 43	185/55R15		1,9 TDI-PD RS (96 kW)
	€ 64,50	Kugel sw 17 M14 x 1,5 x 27		FZG-Schein beachten, unterschiedliche Reifenabmessungen zulässig.
RDKS				



		6Y	07/03-04/07	Fabia	
	Schräg-/Stufenheck, Combi	162701	9680	VO 516005	Stahl
	1,2i (40 kW)/ 1,2i-12V (47 kW)/ 1,4i (44/50 kW)/ 1,4i-16V (55/74 kW)/2,0i (85kW)/1,4 TDI-PD(55kW)/ 1,9 SDI(47 kW)/ 1,9 TDI-PD (74/96 kW)	205/45R16		6½ J x16 H2 5x100x57 ET 42	
	Kugel sw 17 M14 x 1,5 x 27		€ 82,40		
RDKS					

		5J	05/07-10/14	Fabia II	
	Schrägheck, Combi	143502	5210	VO 514015	Renner
	1,2 HTP (44/51 kW)/ 1,2 TSI (63 kW)/ 1,4i-16V (63 kW)/ 1,2 TDI (55 kW)/ 1,4 TDI (51/59 kW)	165/70R14		5 J x14 H2 5x100x57 ET 35	
	Kugel sw 17 M14 x 1,5 x 27		€ 56,00		
RDKS					

		5J	Fabia II		
	CS	MK 303	lichtsilber-lackiert	Celsio	CS 554 38 5 00
			ABE	165/70R14 ❄	5½ J x14 H2 5 x 100 ET 38
			ABE	175/70R14 ❄	
			ASC; ASS; Huf 2.4; Huf 3.4; SE1C1; SE1C2; SE1S; TTC; TTS		
RDKS					

		5J	05/07-10/14	Fabia II	
	Schrägheck, Combi	143405	7250	VO 514020	Stahl
	1,2 HTP (44/51 kW)/ 1,2 TSI (63/77 kW)/ 1,4i-16V (63 kW)/ 1,6-16V (63/77 kW)/ 1,2 TDI (55 kW)/ 1,4 TDI (51/59 kW)/ 1,6 TDI (55/66 kW)	185/60R14		6 J x14 H2 5x100x57 ET 37	
	Kugel sw 17 M14 x 1,5 x 27		€ 58,70		
RDKS					



		5J	Fabia II			
	IN	MK 303	lichtsilber-lackiert / mattschwarz-lackiert	Interio	IN 604 38 5 00	
			Räder nicht zulässig an Fahrzeugen, die als 3-Liter oder 5-Liter Auto eingestuft sind.	ABE	165/70R14	6 J x14 H2 5 x 100 ET 38
			ABE	175/70R14 ❄		
			ABE	185/60R14 ❄		
ASC; ASS; Huf 2.4; Huf 3.4; SE1C1; SE1C2; SE1S; TTC; TTS						
RDKS						

KRONPRINZ
MAGMA

KRONPRINZ
MAGMA

Fabia II		05/07-10/14	5J	
Renner	VO 515025	8000	152507	Schrägheck, Combi
	6 J x15 H2	185/55R15 M+S		1,2 HTTP (44/51 kW)/ 1,2 TSI (63/77 kW)/ 1,4i-16V (63 kW)/
	5x100x57	195/55R15		1,6-16V (63/77 kW)/ 1,2 TDI (55 kW)/ 1,4 TDI (51/59 kW)/
	ET 43			1,6 TDI (55/66/77 kW)/ 1,9 TDI (77 kW)
	€ 64,50	Kugel sw 17 M14 x 1,5 x 27		Einige Ausführungen auch 185/60R15 zulässig.
RDKS				

Fabia II RS		09/10-10/14	5J	
Renner	VO 515025	8000	152507	Schrägheck, Combi
	6 J x15 H2	185/55R15 M+S		1,4 TSI (132 kW)
	5x100x57			
	ET 43			
	€ 64,50	Kugel sw 17 M14 x 1,5 x 27		
RDKS				

Fabia II		5J			
MAGNIA	Celsio	CS 655 35 5 00	lichtsilber-lackiert		
	Tezzo	TZ 655 35 5 00	lichtsilber-lackiert / mattschwarz-lackiert		
	6½ J x15 H2	185/55R15 *	TÜV		
	5 x 100	195/50R15 *	TÜV		
	ET 35	195/55R15 *	TÜV		
RDKS		Celsio: ASC; ASS; CLC; Huf 2.4; Huf 3.4; Huf 3.5; SE1C1; SE1C2; SE15; TTC; TTS Tezzo: ASC; ASS; CLC; Huf 2.4; Huf 3.4; Huf 3.5; SE1C1; SE1C2; SE15; TTC		MK 303	

Fabia II Scout		07/09-10/14	5J	
Renner	VO 515025	8000	152507	Schrägheck, Combi
	6 J x15 H2	185/55R15 M+S		1,2 TSI (63/77 kW)/ 1,4i-16V (63 kW)/ 1,6-16V (63 kW)/
	5x100x57	195/55R15		1,4 TDI (59 kW)/ 1,6 TDI (66/77 kW)/ 1,9 TDI (77 kW)
	ET 43			
	€ 64,50	Kugel sw 17 M14 x 1,5 x 27		Schrägheck 06/10-
RDKS				

Fabia III		11/14-	5J	
Renner	VO 514015	5210	143502	Schrägheck
	5 J x14 H2	165/70R14		1,0 MPI (44/55 kW)/ 1,2 TSI (66 kW)/ 1,4 TDI (66 kW)
	5x100x57	175/70R14		
	ET 35			
	€ 56,00			
RDKS		SE15		

		5J	11/14-	Fabia III	
	Schrägheck		154105	7760	VO 515030
	1,0 MPI (44/55 kW)/ 1,2 TSI (66/81 kW)/ 1,4 TDI (66/77 kW)		185/55R15		6 J x15 H2
			195/55R15		5x100x57
					ET 38
					€ 64,50
			CUC; SE1C1; SE1C2; SE2C1; SE1S; SE2S		
					RDKS

Renner

		5J	Fabia III		
Radabbildung in Vorbereitung					in Vorbereitung
					RDKS

MAGMA

		6Y	06/03-04/07	Fabia Praktik	
	Stadtlieferwagen		143502	5210	VO 514015
	1,2i (47 kW)/ 1,9 SDI (47 kW)		165/70R14		5 J x14 H2
					5x100x57
					ET 35
					€ 56,00
			Kugel sw 17 M14 x 1,5 x 27		
					RDKS

Renner

		1U	04/97-05/04	Octavia I	
	Stufenheck		152503	8380	VO 515011
	1,6 (55/74 kW)/ 1,8 (92 kW)/ 1,8T (110 kW)/		195/65R15		6 J x15 H2
	2,0 (85 kW)/ 1,9TDI (66/81 kW)/				5x100x57
	1,9TDI-PD (96 kW)/ 4x4				ET 38
	FZG-Schein beachten! Bei einigen Ausführungen nur VO 516005 zulässig.				€ 64,50
			Kugel sw 17 M14 x 1,5 x 27		
					RDKS

Stahl

		1U	04/97-05/04	Octavia I	
	Stufenheck		162701	9680	VO 516005
	1,6 (55/74 kW)/ 1,8 (92 kW)/ 1,8T (110 kW)/		205/55R16		6½ J x16 H2
	2,0 (85 kW)/ 1,9TDI (66/81 kW)/				5x100x57
	1,9TDI-PD (96 kW)/ 4x4				ET 42
	FZG-Schein beachten! Bei einigen Ausführungen nur VO 515011 zulässig.				€ 82,40
			Kugel sw 17 M14 x 1,5 x 27		
					RDKS

Stahl





Octavia I Combi			04/97-12/04	1U	
Stahl	VO 515011	8380	152503	Combi	
	6 J x15 H2	195/65R15		1,6 (55/74 kW)/ 1,8 (92 kW)/ 1,8T (110 kW)/	
	5x100x57			2,0 (85 kW)/ 1,9TDI (66/81 kW)/	
	ET 38			1,9TDI-PD (74/96 kW)/ 4x4	
	€ 64,50	Kugel sw 17 M14 x 1,5 x 27		FZG-Schein beachten! Bei einigen Ausführungen nur VO 516005 zulässig.	
RDKS					

Octavia I Combi			04/97-12/04	1U	
Stahl	VO 516005	9680	162701	Combi	
	6½ J x16 H2	205/55R16		1,6 (55/74 kW)/ 1,8 (92 kW)/ 1,8T (110 kW)/	
	5x100x57			2,0 (85 kW)/ 1,9TDI (66/81 kW)/	
	ET 42			1,9TDI-PD (74/96 kW)/ 4x4	
	€ 82,40	Kugel sw 17 M14 x 1,5 x 27		FZG-Schein beachten! Bei einigen Ausführungen nur VO 515011 zulässig.	
RDKS					

Octavia I RS			12/00-10/05	1U	
Stahl	VO 516005	9680	162701	Stufenheck	
	6½ J x16 H2	205/55R16		1,8 Turbo (132 kW)	
	5x100x57				
	ET 42				
	€ 82,40	Kugel sw 17 M14 x 1,5 x 27			
RDKS					

Octavia I RS Combi			05/01-10/05	1U	
Stahl	VO 516005	9680	162701	Combi	
	6½ J x16 H2	205/55R16		1,8 Turbo (132 kW)	
	5x100x57				
	ET 42				
	€ 82,40	Kugel sw 17 M14 x 1,5 x 27			
RDKS					

Octavia I TOUR			06/04-12/10	1U	
Stahl	VO 515011	8380	152503	Stufenheck	
	6 J x15 H2	195/65R15		1,4 (55 kW)/ 1,6 (75 kW)/ 1,9 TDI (66 kW)	
	5x100x57				
	ET 38				
	€ 64,50	Kugel sw 17 M14 x 1,5 x 27		Octavia I (Typ: 1U) wird unter der Bezeichnung „TOUR“ parallel zum neuen Octavia II (Typ: 1Z) weitergebaut. Typkennung im FZG-Schein ist zu beachten. Bei einigen Ausführungen ist nur VO 516005 zulässig.	
RDKS					

		1U	06/04-12/10	Octavia I TOUR	
	Stufenheck	162701	9680	VO 516005	Stahl
	1,4 (55 kW)/ 1,6 (75 kW)/ 1,9 TDI (66 kW)	205/55R16		6½ J x16 H2 5x100x57 ET 42	
	Octavia I (Typ: 1U) wird unter der Bezeichnung „TOUR“ parallel zum neuen Octavia II (Typ: 1Z) weitergebaut. Typkennung im FZG-Schein ist zu beachten. Bei einigen Ausführungen ist nur VO 515011 zulässig.	Kugel sw 17 M14 x 1,5 x 27		€ 82,40	RDKS
		1U	01/05-12/10	Octavia I TOUR Combi	
	Combi	152503	8380	VO 515011	Stahl
	1,6 (75 kW)/ 1,9 TDI (66/81 kW)/ 1,9 TDI (74 kW) 4x4	195/65R15		6 J x15 H2 5x100x57 ET 38	
	Octavia I (Typ: 1U) wird unter der Bezeichnung „TOUR“ parallel zum neuen Octavia II (Typ: 1Z) weitergebaut. Typkennung im FZG-Schein ist zu beachten. Bei einigen Ausführungen ist nur VO 516005 zulässig.	Kugel sw 17 M14 x 1,5 x 27		€ 64,50	RDKS
		1U	01/05-12/10	Octavia I TOUR Combi	
	Combi	162701	9680	VO 516005	Stahl
	1,6 (75 kW)/ 1,9 TDI (66/81 kW)/ 1,9 TDI (74 kW) 4x4	205/55R16		6½ J x16 H2 5x100x57 ET 42	
	Octavia I (Typ: 1U) wird unter der Bezeichnung „TOUR“ parallel zum neuen Octavia II (Typ: 1Z) weitergebaut. Typkennung im FZG-Schein ist zu beachten. Bei einigen Ausführungen ist nur VO 515011 zulässig.	Kugel sw 17 M14 x 1,5 x 27		€ 82,40	RDKS
		1Z	06/04-01/13	Octavia II	
	Stufenheck	154104	9165	VO 515024	Renner
	1,2 TSI/ 1,4i 16V/ 1,6 MPI/ 1,4 TSI/ 1,6 FSI/ 1,8 TSI/ 2,0 FSI/ 1,6 TDI/ 1,9 TDI/ 2,0 TDI	195/65R15		6 J x15 H2 5x112x57 ET 47	
		Kugel sw 17 M14 x 1,5 x 27		€ 63,90	RDKS
		1Z	06/04-01/13	Octavia II	
	Stufenheck	164001	9535	AD 516012	Renner
	1,2 TSI/ 1,4i 16V/ 1,6 MPI/ 1,4 TSI/ 1,6 FSI/ 1,8 TSI/ 2,0 FSI/ 1,6 TDI/ 1,9 TDI/ 2,0 TDI/ 4x4	205/55R16 M+S		6 J x16 H2 5x112x57 ET 50	
		Kugel sw 17 M14 x 1,5 x 27		€ 74,50	RDKS



Octavia II			06/04-01/13	1Z	
Renner	VO 516015	9915	163902	Stufenheck	
	6½ J x16 H2	205/55R16		1,2 TSI/ 1,4i 16V/ 1,6 MPI/ 1,4 TSI/ 1,6 FSI/ 1,8 TSI/ 2,0 FSI/ 1,6 TDI/ 1,9 TDI/ 2,0 TDI/ 4x4	
	5x112x57				
	ET 50				
	€ 75,00	Kugel sw 17 M14 x 1,5 x 27			
RDKS					

Octavia II Combi			01/05-04/13	1Z	
Renner	VO 515024	9165	154104	Combi	
	6 J x15 H2	195/65R15		1,2 TSI/ 1,4i 16V/ 1,6 MPI/ 1,4 TSI/ 1,6 FSI/ 1,8 TSI/ 2,0 FSI/ 1,6 TDI/ 1,9 TDI/ 2,0 TDI	
	5x112x57				
	ET 47				
	€ 63,90	Kugel sw 17 M14 x 1,5 x 27			
RDKS					

Octavia II / Octavia II Combi				1Z		
MAGNA	Interio		IN 605 45 5 12	lichtsilber-lackiert / mattschwarz-lackiert		
	6 J x15 H2	195/65R15	⊗	ABE		
	5 x 112	205/60R15	⊗	ABE		
	ET 45					
RDKS	ASC; ASS; CUS; Huf 2.4; Huf 3.4; SE1C1; SE1C2; SE15; TTC; TTS			MK 306	IN	IN

Octavia II Combi			01/05-04/13	1Z	
Renner	AD 516012	9535	164001	Combi	
	6 J x16 H2	205/55R16 M+S		1,2 TSI/ 1,4i 16V/ 1,6 MPI/ 1,4 TSI/ 1,6 FSI/ 1,8 TSI/ 2,0 FSI/ 1,6 TDI/ 1,9 TDI/ 2,0 TDI/ 4x4	
	5x112x57				
	ET 50				
	€ 74,50	Kugel sw 17 M14 x 1,5 x 27			
RDKS					

Octavia II Combi			01/05-04/13	1Z	
Renner	VO 516015	9915	163902	Combi	
	6½ J x16 H2	205/55R16		1,2 TSI/ 1,4i 16V/ 1,6 MPI/ 1,4 TSI/ 1,6 FSI/ 1,8 TSI/ 2,0 FSI/ 1,6 TDI/ 1,9 TDI/ 2,0 TDI/ 4x4	
	5x112x57				
	ET 50				
	€ 75,00	Kugel sw 17 M14 x 1,5 x 27			
RDKS					

		1Z	Oktavia II / Oktavia II Combi / Oktavia II Scout		
		lichtsilber-lackiert		Celsio	CS 656 50 5 12
		lichtsilber-lackiert / mattschwarz-lackiert		Tezzo	TZ 656 50 5 12
Räder auch für Oktavia Scout Bereifung 205/55R16 M+S ABE + SKF		ABE	205/55R16	6½ J x16 H2	
		ABE	205/55R16 M+S	5 x 112	
				ET 50	
CS	TZ	MK 306	Celsio: ASC; ASS; CUC; Huf 2.4; Huf 3.4; Huf 3.5; SE1C1; SE1C2; SE15; TTC; TTS Tezzo: ASC; ASS; CUC; Huf 2.4; Huf 3.4; Huf 3.5; SE1C1; SE1C2; SE15; TTC		

MAGNA

RDKS

		1Z	06/05-01/13	Oktavia II RS	
	Stufenheck, Combi 2,0 TFSI (147 kW) / 2,0 TDI (125 kW)	164001	9535	AD 516012	
		205/55R16 M+S		6 J x16 H2	
		Kugel sw 17 M14 x 1,5 x 27		5x112x57	
				ET 50	
				€ 74,50	

Renner

RDKS

		1Z	01/07-04/12	Oktavia II Scout	
	Combi 1,8 TSI / 2,0 FSI / 2,0 TDI	164001	9535	AD 516012	
		205/55R16 M+S		6 J x16 H2	
		Kugel sw 17 M14 x 1,5 x 27		5x112x57	
				ET 50	
				€ 74,50	

Renner

RDKS

		5E	02/13-	Oktavia III / Octavia III Combi	
	Stufenheck, Kombi 1,2 TSI (63/77/81 kW) / 1,6 TDI (66/77/81 kW)	155801	7755	VO 515031	
		195/65R15		6 J x15 H2	
		Kugel sw 17 M14 x 1,5 x 27		5x112x57	
Einige Ausführungen nur LM-Räder!				ET 43	
				€ 67,10	
		ASC; ASS; CUC; Huf 3.5; SE1C1; SE1C2; SE2C1; SE15; SE25			

Renner

RDKS

		5E	02/13-	Oktavia III / Octavia III Combi	
	Stufenheck, Kombi 1,2 TSI (63/77/91 kW) / 1,4 TSI G-Tec (81 kW) / 1,4 TSI (103/110 kW) / 1,8 TSI (132 kW) / 1,6 TDI (66/77/81/110 kW) / 2,0 TDI (110/135 kW)	165601	8247	VO 516034	
		205/55R16 M+S		6 J x16 H2	
		Kugel sw 17 M14 x 1,5 x 27		5x112x57	
Einige Ausführungen nur LM-Räder!				ET 48	
				€ 78,20	
		ASS; CUC; Huf 2.4; Huf 3.4; Huf 3.5; SE1C1; SE1C2; SE2C1; SE2C2; SE15; SE25			

Renner

RDKS

Octavia III / Octavia III Combi		02/13-	5E	
Renner	VO 516035	8667	165305	Stufenheck, Kombi
	6½ J x16 H2	205/55R16		1,2 TSI (63/77/81 kW)/ 1,4 TSI G-Tec (81 kW)/ 1,4 TSI (103/110 kW)/ 1,8 TSI (132 kW)/ 1,6 TDI (66/77/81/110 kW)/ 2,0 TDI (110/135 kW)
	5x112x57			
	ET 46			
	€ 78,50	Kugel sw 17 M14 x 1,5 x 27		Einige Ausführungen nur LM-Räder!
RDKS	ASC; ASS; CUC; Huf 2.4; Huf 3.4; Huf 3.5; SE1C1; SE1C2; SE2C1; SE2C2; SE1S; SE2S			



Octavia III / Oktavia III Combi		5E				
MAGNA	Celsio	CS 656 50 5 12	lichtsilber-lackiert			
	Tezzo	TZ 656 50 5 12	lichtsilber-lackiert / mattschwarz-lackiert			
	6½ J x16 H2	205/55R16	ABE	Freigabe für Oktavia Scout in Vorbereitung		
	5 x 112	215/50R16 *	ABE			
ET 50						
RDKS	Celsio: ASC; ASS; CUC; Huf 2.4; Huf 3.4; Huf 3.5; SE1C1; SE1C2; SE1S; TTC; TTS Tezzo: ASC; ASS; CUC; Huf 2.4; Huf 3.4; Huf 3.5; SE1C1; SE1C2; SE1S; TTC			MK 306	CS	TZ

Octavia III / Oktavia III Combi		5E				
MAGNA	Interio	IN 706 45 5 12	lichtsilber-lackiert / mattschwarz-lackiert			
	7 J x16 EH2+	205/55R16 *	ABE	Freigabe für Oktavia Scout in Vorbereitung		
	5 x 112	215/50R16 *	ABE			
	ET 45					
RDKS	ASC; CUC; Huf 2.4; Huf 3.4; Huf 3.5; SE1C1; SE1S			MK 306	IN	IN

Octavia III / Oktavia III Combi		5E				
MAGNA	Tezzo	TZ 757 50 5 12	lichtsilber-lackiert / mattschwarz-lackiert			
	7½ J x17 H2	205/45R17 *	ABE	Freigabe für Oktavia Scout in Vorbereitung		
	5 x 112	215/45R17	ABE			
	ET 50	225/45R17	ABE			
RDKS	ASC; ASS; CUC; Huf 2.4; Huf 3.4; Huf 3.5; SE1C1; SE1C2; SE1S			MK 306	TZ	TZ



Octavia III Scout		09/14-	5E	
Renner	VO 516034	8247	165601	Kombi
	6 J x16 H2	205/55R16 M+S		1,8 TFSI (132 kW)/ 2,0 TDI (110/135 kW)
	5x112x57	205/60R16 M+S		
	ET 48			
	€ 78,20	Kugel sw 17 M14 x 1,5 x 27		Je nach Ausführung unterschiedliche Bereifung zulässig!
RDKS	ASS; CUC; Huf 2.4; Huf 3.4; Huf 3.5; SE1C1; SE1C2; SE2C1; SE2C2; SE1S; SE2S			





		5E	09/14-	Octavia III Scout	
	Kombi	165305	8667	VO 516035	Renner
	1,8 TFSI (132 kW)/ 2,0 TDI (110/135 kW)	205/55R16		6½ J x16 H2 5x112x57 ET 46	
	Einige Ausführungen nur 6J x 16 H2 ET 48.	Kugel sw 17 M14 x 1,5 x 27		€ 78,50	RDKS
		ASC; ASS; CUC; Huf 2.4; Huf 3.4; Huf 3.5; SE1C1; SE1C2; SE2C1; SE2C2; SE1S; SE2S			
		5J	04/07-	Praktik	
	Kasten	143502	5210	VO 514015	Renner
	1,2i (51 kW)/ 1,2 TSI (63 kW)/ 1,4i (63 kW)/ 1,4 TDi (51 kW)	175/70R14		5 J x14 H2 5x100x57 ET 35	
	Einige Ausführungen nur 15 Zoll!	Kugel sw 17 M14 x 1,5 x 27		€ 56,00	RDKS
		SE1S			
		5J	04/07-	Praktik	
	Kasten	143405	7250	VO 514020	Stahl
	1,2i (51 kW)/ 1,2 TSI (63 kW)/ 1,4i (63 kW)	185/65R14		6 J x14 H2 5x100x57 ET 37	
	Einige Ausführungen nur 15 Zoll!	Kugel sw 17 M14 x 1,5 x 27		€ 58,70	RDKS
		CUC; SE1C1; SE2C1; SE2C2; SE1S; SE2S			
		5J	04/07-	Praktik	
	Kasten	152507	8000	VO 515025	Renner
	1,2i (51 kW)/ 1,2 TSI (63 kW)/ 1,4i (63 kW)/ 1,4 TDi (51 kW)/ 1,6 TDi (55/66 kW)	185/55R15 M+S 195/55R15		6 J x15 H2 5x100x57	
	1,2i (51 kW)/ 1,2 TSI (63 kW)/ 1,6 TDi (55 kW)	185/60R15		ET 43	
	Je nach Ausführung unterschiedliche Reifenabmessungen zulässig!	Kugel sw 17 M14 x 1,5 x 27		€ 64,50	
		ASS; Huf 3.5; SE1S; SE2S			
		NH	10/12-	Rapid / Rapid Spaceback	
	Stufenheck, Kombi	143502	5210	VO 514015	Renner
	1,2 MPI (55kW)/ 1,2 TSI (63 kW)	175/70R14		5 J x14 H2 5x100x57 ET 35	
		Kugel sw 17 M14 x 1,5 x 27		€ 56,00	RDKS
		SE1S			



Rapid / Rapid Spaceback			NH		
MAGNA	Celsio		CS 554 38 5 00	lichtsilber-lackiert	
	5½ J x14 H2	175/70R14	☼	ABE	
	5 x 100	185/65R14	☼	ABE	
	ET 38				
RDKS	ASC; ASS; Huf 2.4; Huf 3.4; SE1C1; SE1C2; SE1S; TTC; TTS			MK 303	CS

Rapid / Rapid Spaceback		10/12-	NH		
Renner	VO 515030	7760	154105	Stufenheck, Kombi	
	6 J x15 H2	185/60R15		1,2 MPI (55kW)/ 1,2 TSI (63/66/77/81 kW)/ 1,4 TSI (90/92 kW)/	
	5x100x57	195/55R15		1,6 MPI (77 kW)/ 1,4 TDI (66 kW)/ 1,6 TDI (66/77/85 kW)	
	ET 38				
	€ 64,50	Kugel sw 17 M14 x 1,5 x 27			
RDKS	CUC; SE1C1; SE1C2; SE2C1; SE1S; SE2S				

Rapid / Rapid Spaceback			NH			
MAGNA	Interio		IN 605 35 5 00	lichtsilber-lackiert / mattschwarz-lackiert		
	6 J x15 H2	185/60R15	ABE			
	5 x 100	195/55R15	ABE			
	ET 35					
RDKS	ASC; ASS; CUS; Huf 2.4; Huf 3.4; SE1C1; SE1C2; SE1S; TTC; TTS			MK 303	IN	IN

Roomster		09/06-	5J		
Renner	VO 514015	5210	143502	Van	
	5 J x14 H2	175/70R14		1,2 HTP (47/51 kW)/ 1,2 TSI (63 kW)/ 1,4i-16V (63 kW)/	
	5x100x57			1,4 TDI (51 kW)	
	ET 35				
	€ 56,00	Kugel sw 17 M14 x 1,5 x 27		Fahrzeugschein beachten. Einige Ausführungen nur 15 Zoll zulässig.	
RDKS	SE1S				

Roomster		09/06-	5J		
Stahl	VO 514020	7250	143405	Van	
	6 J x14 H2	185/65R14		1,2 HTP (47/51 kW)/ 1,2 TSI (63 kW)/ 1,4i-16V (63 kW)/	
	5x100x57			1,4 TDI (51 kW)	
	ET 37				
	€ 58,70	Kugel sw 17 M14 x 1,5 x 27		Fahrzeugschein beachten. Einige Ausführungen nur 15 Zoll zulässig.	
RDKS	CUC; SE1C1; SE2C1; SE2C2; SE1S; SE2S				



		5J	Roomster		
		lichtsilber-lackiert / mattschwarz-lackiert		Interio	IN 604 38 5 00
		Räder nicht zulässig an Fahrzeugen, die als 3-Liter oder 5-Liter Auto eingestuft sind.		ABE 175/70R14 ✱ ABE 185/65R14 ✱	6 J x14 H2 5 x 100 ET 38
IN	IN	MK 303	ASC; ASS; Huf 2.4; Huf 3.4; SE1C1; SE1C2; SE1S; TTC; TTS		

KRONPRINZ
MAGNA

RDKS

		5J	09/06-	Roomster	
	Van	152507	8000	VO 515025	Renner
	1,2 HTP (47/51 kW)/ 1,2 TSI (63/77 kW)/ 1,4i-16V (63 kW)/ 1,6i-16V (77 kW)/ 1,4 TDI (51/59 kW)/ 1,6 TDI (66/77 kW)/ 1,9 TDI (77 kW)	185/55R15 M+S 185/60R15 195/55R15		6 J x15 H2 5x100x57 ET 43	
Je nach Ausführung unterschiedliche Reifenabmessungen zulässig!		Kugel sw 17 M14 x 1,5 x 27		€ 64,50	RDKS
		ASS; Huf 3.5; SE1S; SE2S			

		5J	03/07-	Roomster Scout	
	Van	152507	8000	VO 515025	Renner
	1,2 TSI (63/77 kW)/ 1,4i-16V (63 kW)/ 1,6i-16V (77 kW)/ 1,4 TDI (59 kW)/ 1,6 TDI (66/77 kW)/ 1,9 TDI (77 kW)	185/55R15 M+S 195/55R15		6 J x15 H2 5x100x57 ET 43	
		Kugel sw 17 M14 x 1,5 x 27		€ 64,50	RDKS
		ASS; Huf 3.5; SE1S; SE2S			

		5J	Roomster / Roomster Scout		
		lichtsilber-lackiert		Celsio	CS 655 35 5 00
		lichtsilber-lackiert / mattschwarz-lackiert		Tezzo	TZ 655 35 5 00
Auflagen beachten! Rad auch für Roomster Scout Bereifung 185/55R15 ABE + SKF		TÜV	185/55R15 ✱ 195/50R15 ✱ 195/55R15 ✱	6½ J x15 H2 5 x 100 ET 35	Renner
CS	TZ	MK 303	Celsio: ASC; ASS; CUC; Huf 2.4; Huf 3.4; Huf 3.5; SE1C1; SE1C2; SE1S; TTC; TTS Tezzo: ASC; ASS; CUC; Huf 2.4; Huf 3.4; Huf 3.5; SE1C1; SE1C2; SE1S; TTC		

KRONPRINZ
MAGNA

RDKS



		2016-	Snowman		
Radabbildung in Vorbereitung	SUV INFO			INFO	Stahl
					RDKS



RDKS

Snowman			
KRONPRINZ MAGNA	in Vorbereitung		Radabbildung in Vorbereitung
RDKS			



Superb I		03/02-06/08	3U	
Stahl	*AD 516004	9490	162201	Stufenheck 1,8T (110 kW)/ 2,0i (85 kW)/ 2,8 V6 (142 kW)/ 1,9 TDI (74/ 96 kW)/ 2,5 V6 TDI (114/120 kW)
	6 J x16 H2	205/55R16 M+S		
	5x112x57			
	ET 40			
	€ 81,40	Kugel sw 17 M14 x 1,5 x 27		Die Radkappen vom 7 x 16 Rad können nicht verbaut werden!
RDKS				

Superb II / Superb II Combi		07/08-03/15	3T	
Renner	VO 516029	9257	163307	Stufenheck, Combi 1,4 FSI/TSI (92 kW)/ 1,8 TSI (118 kW)/ 1,9 TDI (77 kW)/ 2,0 TDI (103/125 kW)/4x4 Superb Combi 06/10- Nicht zulässig für 3,6 V6 (191 kW)!
	7 J x16 H2	205/55R16		
	5x112x57			
	ET 45			
	€ 78,20	Kugel sw 17 M14 x 1,5 x 27		
RDKS			ASS; CUC; Huf 3.5; SE1C1; SE2C1; SE2C2	

Superb II / Superb II Combi			3T		
KRONPRINZ MAGNA	Celsio	CS 706 45 5 12	lichtsilber-lackiert		
	Interio	IN 706 45 5 12	lichtsilber-lackiert / mattschwarz-lackiert		
	7 J x16 EH2+	205/55R16 ❄	ABE		
	5 x 112	225/50R16	ABE		
	ET 45				
RDKS			Celsio: ASC; CUC; Huf 3.4; Huf 3.5; SE1C1; SE1S Interio: ASC; CUC; Huf 2.4; Huf 3.4; Huf 3.5; SE1C1; SE1S	MK 306	



Superb II / Superb II Combi			3T		
KRONPRINZ MAGNA	Tezzo	TZ 757 50 5 12	lichtsilber-lackiert / mattschwarz-lackiert		
	7½ J x17 H2	205/50R17 M+S	ABE		
	5 x 112	225/45R17	ABE		
	ET 50				
RDKS			ASC; ASS; CUC; Huf 2.4; Huf 3.4; Huf 3.5; SE1C1; SE1C2; SE1S	MK 306	



		3T	04/15-	Superb III / Superb III Combi	
	Stufenheck, Combi	165306	8426	VO 516037	
	1,4 TFSI (92 kW) / 1,4 TSI (110 kW) / 1,8 TFSI (132 kW) / 1,6 TDI (88 kW) / 2,0 TDI (110/140 kW) / 4x4	215/60R16		6½ J x16 H2	
Nicht 162/206 kW				5x112x57	
				ET 41	
				€ 80,30	
		ASC; ASS; CUC; Huf 2.4; Huf 3.4; Huf 3.5; SE1C1; SE1C2; SE2C1; SE2C2; SE1S; SE2S		Renner	
				RDKS	

		3T	Superb III / Superb III Combi			
		lichtsilber-lackiert / mattschwarz-lackiert		Interio	IN 706 38 5 12	
		Freigabe in Vorbereitung!				7 J x16 EH2+
						5 x 112
						ET 38
		MK 306	ASC; CUC; Huf 2.4; Huf 3.4; Huf 3.5; SE1C1; SE1S		Renner	
						RDKS

		5L	10/09-	Yeti	
	SUV	164001	9535	AD 516012	
	1,2 TSI (77/81 kW) / 1,4 TSI (90/92/110 kW) / 1,8 TFSI/TSI (112/118 kW) / 1,6 TDI (77 kW) / 2,0 TDI (81/103/110/125 kW) / 4x4	205/55R16 M+S		6 J x16 H2	
				5x112x57	
				ET 50	
		Kugel sw 17 M14 x 1,5 x 27		€ 74,50	
				Renner	
				RDKS	



		5L	10/09-	Yeti	
	SUV	163307	9257	VO 516029	
	1,2 TSI (77/81 kW) / 1,4 TSI (90/92/110 kW) / 1,8 TFSI/TSI (112/118 kW) / 1,6 TDI (77 kW) / 2,0 TDI (81/103/110/125 kW) / 4x4	205/55R16 M+S		7 J x16 H2	
		215/60R16		5x112x57	
				ET 45	
		Kugel sw 17 M14 x 1,5 x 27		€ 78,20	
		ASC; CUC; Huf 3.5; SE1C1; SE2C1; SE2C2		Renner	
				RDKS	

		5L	Yeti			
		lichtsilber-lackiert		Celsio	CS 706 38 5 12	
		lichtsilber-lackiert / mattschwarz-lackiert		Interio	IN 706 38 5 12	
				ABE	205/55R16 M+S ❄	7 J x16 EH2+
				ABE	215/55R16 ❄	
				ABE	215/60R16	ET 38
		MK 306	Celsio: ASC; CUC; Huf 3.4; Huf 3.5; SE1C1; SE1S Interio: ASC; CUC; Huf 2.4; Huf 3.4; Huf 3.5; SE1C1; SE1S		Renner	
						RDKS

Yeti			5L			
MAGMA	Tezzo		TZ 757 50 5 12		lichtsilber-lackiert / mattschwarz-lackiert	
	7½ J x17 H2	205/50R17 M+S ❄	ABE			
	5 x 112	225/45R17 ❄	ABE			
	ET 50	235/45R17	ABE			
RDKS	ASC; ASS; CUC; Huf 2.4; Huf 3.4; Huf 3.5; SE1C1; SE1C2; SE1S			MK 306		
				TZ	TZ	

SUBARU

Forester			03/08-	SH, SJ		
Stahl	SB 516004	9552	163462	SUV		
	6½ JJ x16 CH	215/65R16		2,0i (110 kW)		
	5x100x56					
	ET 48					
€ 97,70	Kegel sw 19 M12 x 1,25					
RDKS	ASC; ASS; CUC; Huf 2.4; Huf 3.4; Huf 3.5; SE1C1; SE1C2; SE2C2; SE1S; SE2S / OE: Schrader 3064					



Forester			SH, SJ			
MAGMA	Seismo		SO 706 38 5 00		lichtsilber-lackiert / mattschwarz-lackiert	
	Interio		IN 706 38 5 00		lichtsilber-lackiert / mattschwarz-lackiert	
	7 J x16 H2	215/65R16 M+S ❄	ABE	Bremsanlage beachten		
	5 x 100					
ET 38						
RDKS	Seismo: ASC; ASS; CUC; Huf 2.4; Huf 3.4; Huf 3.5; SE1C2; SE1S; TTC; TTS / OE: Schrader 3064 Interio: ASC; CUC; Huf 2.4; Huf 3.4; Huf 3.5; SE1C1; SE1S			MK 012		
				SO	IN	

G3X Justy			09/03-02/11	NH		
Stahl	SU 514005	4920	143625	Schrägheck		
	4½ J x14 CH	165/70R14		1,3i (69 kW) / 1,5i (73 kW)		
	4x100x54					
	ET 45					
€ 57,50	Kegel sw 17 M12 x 1,5 x 22					
RDKS						



		G3	09/07-	Impreza	
	Schrägheck 1,5R (79 kW)	154652	8036	*SB 515004	Stahl
		195/65R15		6 JJ x15 CH 5x100x56 ET 48	
		Kegel sw 19 M12 x 1,25		€ 81,60	RDKS

		G4	08/12-	Impreza	
	Stufenheck 1,6i (84 kW)	154546	8037	SB 515005	Stahl
		195/65R15		6 J x15 CH 5x100x56 ET 48	
				€ 79,50	RDKS
		ASC; ASS; CUC; CUS; Huf 2.4; Huf 3.4; Huf 3.5; SE1S; TTC / OE: Schrader 3064			



		BM/BR, BM/BRS	11/09-12/14	Legacy	
	Stufenheck, Station 2,0i (110 kW)/ 2,5i (123 kW)/ 2,0D (110 kW)	163462	9552	SB 516004	Stahl
		205/60R16		6½ JJ x16 CH 5x100x56 ET 48	
Nicht zulässig für Subaru Outback ab 11/09-.		Kegel sw 19 M12 x 1,25		€ 97,70	RDKS
		ASC; ASS; CUC; Huf 2.4; Huf 3.4; Huf 3.5; SE1C1; SE1C2; SE2C2; SE1S; SE2S / OE: Schrader 3064			

		BM/BR, BMG/BRG, BM/BRS		Legacy / Legacy Outback	
		lichtsilber-lackiert / mattschwarz-lackiert		Seismo	SO 706 38 5 00
		lichtsilber-lackiert / mattschwarz-lackiert		Interio	IN 706 38 5 00
SO	IN	Räder auch für Legacy Outback mit Bereifung 215/65R16 + 225/60R16	ABE	205/55R16	7 J x16 H2 5 x 100 ET 38
			ABE	205/60R16	
		MK 012	Seismo: ASC; ASS; CUC; Huf 2.4; Huf 3.4; SE1C2; SE1S; TTC; TTS / OE: Schrader 3064 Interio: ASC; CUC; Huf 2.4; Huf 3.4; Huf 3.5; SE1C1; SE1S		

		D1(a)	03/11-	Trezia	
	Mini-Van 1,3i (73 kW)/ 1,4D (66 kW)	154649	7210	TO 515017	Stahl
		185/65R15		5½ J x15 CH 5x100x54 ET 45	
		Kegel sw 19 M12 x 1,5		€ 77,50	RDKS
		ASC; ASS; CUC; CUS; Huf 2.4; Huf 3.4; Huf 3.5; SE1C1; SE1C2; SE1S; TTC / OE: Schrader 3064			

XV			G4			
MAGNA	Interio		IN 706 38 5 00		lichtsilber-lackiert / mattschwarz-lackiert	
	7 J x16 EH2+	215/65R16M+S	⊛	ABE		
	5 x 100	225/60R16M+S	⊛	TÜV		
	ET 38					
RDKS	ASC; CUC; Huf 2.4; Huf 3.4; Huf 3.5; SE1C1; SE1S			MK 012		IN

SUZUKI

Alto			04/09-09/14	GF		
Stahl	SU 514008	5400	143767	Steilheck		
	4½ J x14 CH	155/65R14		1,0 (50 kW)		
	4x100x54					
	ET 45					
RDKS	€ 58,70	Kegel sw 19 M12 x 1,25				
Celerio			10/14-	LF		
Stahl	SU 514010	3000	143612	Steilheck	Radabbildung in Vorbereitung	
	5 J x14 H2	165/65R14		1,0i (50 kW)		
	4x100x54					
	ET 45					
RDKS	€ 59,70					
Grand Vitara			JT			
MAGNA	Celsio		CS 656 40 5 14		lichtsilber-lackiert	
	Tezzo		TZ 656 40 5 14		lichtsilber-lackiert / mattschwarz-lackiert	
	6½ J x16 H2	215/70R16	⊛	ABE		
	5 x 114,3	225/70R16		ABE		
ET 40	235/65R16		ABE			
RDKS	Celsio: ASC; ASS; CUC; Huf 2.4; Huf 3.4; Huf 3.5; SE1C1; SE1C2; SE1S; TTC; TTS / OE: VDO Tezzo: ASC; ASS; CUC; Huf 2.4; Huf 3.4; Huf 3.5; SE1C1; SE1C2; SE1S; TTC / OE: VDO			MK 016		CS

		LY	04/15-	Vitara	
Radabbildung in Vorbereitung	SUV	163406	6525	SU 516008	
	1,6i (88 kW)/ AWD	215/60R16		6½ J x16 H2 5x114,3x60 ET 50 € 79,50	
RDKS					

		LY	Vitara	
Radabbildung in Vorbereitung				in Vorbereitung
RDKS				

KRONPRINZ
MAGMA

		MH	09/03-	Ignis II	
	Schrägheck	143625	4920	SU 514005	
	1,3i (69 kW)/ 1,5i (73 kW)/ 1,3 DDiS (51 kW)/ 4x4	165/70R14		4½ J x14 CH 4x100x54 ET 45 € 57,50	
		Kegel sw 17 M12 x 1,5 x 22		€ 57,50	
RDKS					

		FR	10/10-07/15	Kizashi	
	Stufenheck	163437	9107	SU 516006	
	2,4i (131 kW)	215/60R16		6½ J x16 H2 5x114,3x60 ET 50 € 87,10	
RDKS					

		EX	04/08-09/14	Splash	
	Steilheck	143756	5155	SU 514006	
	1,0i (48 kW)/ 1,2i (63 kW)/ 1,3 DDiS (55 kW)	165/70R14		5 J x14 CH 4x100x54 ET 45 € 59,70	
		Kegel sw 17 M12 x 1,5 x 22		€ 59,70	
RDKS					



Splash			04/08-09/14	EX	
Stahl	SU 515003	7380	154653	Steilheck	
	5½ J x15 CH 4x100x54 ET 50	185/60R15		1,0i (48 kW)/ 1,2i (63 kW)/ 1,3 DDiS (55 kW)	
	€ 69,20	Kegel sw 17 M12 x 1,5 x 22			
RDKS					

Swift			05/05-08/10	EZ, MZ	
Stahl	SU 514006	5155	143756	Schrägheck	
	5 J x14 CH 4x100x54 ET 45	165/70R14		1,3i (68 kW)/ 1,5i (75 kW)/ 1,3DDiS (51 kW)/ 4x4	
	€ 59,70	Kegel sw 17 M12 x 1,5 x 22		Typ EZ: Radmuttern Kegel sw 19 M12 x 1,25	
RDKS					

Swift			EZ, MZ			
MAGNA	Celsio	CS 554 35 4 00	lichtsilber-lackiert			
	5½ J x14 H2	165/70R14	⊗	ABE		Typ EZ = MK011 / Typ MZ = MK206
	4 x 100	175/65R14	⊗	ABE		
	ET 35	185/60R14	⊗	ABE		
RDKS			ASC; ASS; Huf 2.4; Huf 3.4; SE1C1; SE1C2; SE1S; TTC; TTS		MK 011 / MK 206	

Swift Sport			07/06-08/10	MZ	
Stahl	SU 515002	7150	154651	Schrägheck	
	6 J x15 H2 5x114,3x60 ET 50	185/60R15		1,6i 16V (92 kW)	
	€ 71,30	Kegel sw 17 M12 x 1,5 x 22			
RDKS					

Swift			09/10-	FZ, NZ	
Stahl	SU 515004	6735	154654	Schrägheck	
	5 J x15 H2 4x100x54 ET 40	175/65R15		1,3i (69 kW)/ 1,3D (55 kW)	
	€ 69,70	Kegel sw 17 M12 x 1,5 x 26		Typ FZ: Radmuttern Kegel sw 19 M12 x 1,25	
RDKS			ASC; ASS; CUC; CUS; Huf 2.4; Huf 3.4; Huf 3.5; SE1C2; SE2C2; SE2S; TTC; TTS / OE: VDO S180052024Z		

		FZ, NZ	Swift		
		lichtsilber-lackiert / mattschwarz-lackiert		Interio	IN 605 38 4 00
		Typ FZ = MK011 / Typ NZ = MK206	ABE	175/60R15 ❄	6 J x15 H2 4 x 100 ET 38
			ABE	175/65R15 ❄	
		ABE	185/60R15 ❄		
IN	IN	MK 011 / MK 206	ASC; ASS; CUS; Huf 2.4; Huf 3.4; SE1C1; SE1C2; SE1S; TTC; TTS		RDKS

KRONPRINZ
MAGMA

		NZ	Swift Sport		
		lichtsilber-lackiert / mattschwarz-lackiert		Seismo	SO 656 45 5 14
		Achtung 5 Loch Ausführung	ABE	195/50R16	6½ J x16 H2 5 x 114,3 ET 45
			ABE	205/45R16	
		MK 203	ASC; ASS; CUC; Huf 2.4; Huf 3.4; Huf 3.5; SE1C1; SE1C2; SE1S; TTC; TTS / OE: VDO S180052024Z		RDKS

KRONPRINZ
MAGMA

		EY, GY	06/06-11/13	SX4	
	SUV, Stufenheck		154651	7150	SU 515002
	1,5i (73 kW) / 1,6 VVT (79/88 kW) / 1,9 DDiS (88 kW) / 2,0 DDiS (99 kW) / 2WD / 4WD		195/65R15		6 J x15 H2 5x114,3x60 ET 50
	Typ GY: Radmuttern Kegel sw 19 M12 x 1,25		Kegel sw 17 M12 x 1,5 x 22		€ 71,30
					RDKS

Stahl



		EY, GY	06/06-11/13	SX4	
	SUV, Stufenheck		163435	8315	SU 516004
	1,5i (73 kW) / 1,6 VVT (79/88 kW) / 1,9 DDiS (88 kW) / 2,0 DDiS (99 kW) / 2WD / 4WD		205/60R16		6 J x16 CH 5x114,3x60 ET 50
	Typ GY: Radmuttern Kegel sw 19 M12 x 1,25		Kegel sw 17 M12 x 1,5 x 22		€ 78,20
					RDKS

Stahl



		EY, GY	12/13-06/15	SX4 Classic	
	SUV		154651	7150	SU 515002
	1,6i (88 kW) / 2,0 DDiS (99 kW) / 2WD / 4WD		195/65R15		6 J x15 H2 5x114,3x60 ET 50
	Fahrzeug wird parallel zur neuen Baureihe weitergebaut! Typ GY: Radmuttern Kegel sw 19 M12 x 1,25		Kegel sw 17 M12 x 1,5 x 22		€ 71,30
					RDKS

Stahl

SX4 Classic			12/13-06/15	EY, GY	
Stahl	SU 516004	8315	163435	SUV	
	6 J x16 CH	205/60R16		1,6i (88 kW)/ 2,0 DDiS (99 kW)/ 2WD/ 4WD	
	5x114,3x60 ET 50				
	€ 78,20	Kegel sw 17 M12 x 1,5 x 22		Fahrzeug wird parallel zur neuen Baureihe weitergebaut! Typ GY: Radmuttern Kegel sw 19 M12 x 1,25	
RDKS					

SX4				EY, GY, EY-2			
MAGMA	Tezzo		TZ 656 40 5 14	lichtsilber-lackiert / mattschwarz-lackiert			
	6½ J x16 H2	205/55R16	⊗	ABE	Typ EY,EY-2 = MK203 / Typ GY = MK016		
	5 x 114,3	205/60R16	⊗	ABE			
	ET 40	215/55R16	⊗	ABE			
RDKS			ASC; ASS; CUC; Huf 2.4; Huf 3.4; Huf 3.5; SE1C1; SE1C2; SE1S; TTC	MK 203 / MK 016		TZ	TZ



SX4 S-Cross			12/13-	JY	
Stahl	SU 516007	8183	163377	SUV	
	6 J x16 H2	205/60R16		1,6i (88 kW)/ 1,6 DDiS (88 kW)/ 4x4	
	5x114,3x60 ET 50				
	€ 78,20				
RDKS			ASC; ASS; CUC; CUS; Huf 2.4; Huf 3.4; Huf 3.5; SE1C2; SE1S; TTC / OE: VDO S180052024Z		

SX4 S-Cross				JY			
MAGMA	Tezzo		TZ 656 40 5 14	lichtsilber-lackiert / mattschwarz-lackiert			
	6½ J x16 H2	205/55R16	⊗	ABE			
	5 x 114,3	205/60R16	⊗	ABE			
	ET 40						
RDKS			ASC; ASS; CUC; Huf 2.4; Huf 3.4; Huf 3.5; SE1C1; SE1C2; SE1S; TTC / OE: VDO S180052024Z	MK 203		TZ	TZ



WagonR+			09/03-03/08	MM	
Stahl	SU 514005	4920	143625	Mini-Van	
	4½ J x14 CH	155/65R14		1,0i (39 kW)	
	4x100x54 ET 45	165/60R14		1,3i (69 kW)/ 1,3i 4x4 (69 kW)/ 1,3DDiS (51 kW)	
	€ 57,50	Kegel sw 17 M12 x 1,5 x 22		EGBE: e4*2001/116*0042*	
RDKS					

E15J(a), E15UT(a)		03/07-03/13		Auris	
	Schrägheck	154669	9157	TO 515012	Stahl
	1,3 VVTi (73 kW) / 1,4 VVTi (71 kW) / 1,4 D-4D (66 kW)	195/65R15		6 J x15 H2 5x114,3x60 ET 39	
	Einige Ausführungen nur 16 Zoll. Bis EGBE Nachtrag *13.	Kegel sw 21 M12 x 1,5/H17		€ 72,40	
RDKS					

E15J(a), E15UT(a)		03/07-03/13		Auris	
	Schrägheck	163415	7865	TO 516009	Stahl
	1,3 VVTi (73 kW) / 1,4 VVTi (71 kW) / 1,6 VVTi (91 kW) / 1,4 D-4D (66 kW) / 2,0 D-4D (93 kW)	205/55R16		6½ J x16 H2 5x114,3x60 ET 45	
	Bis EGBE Nachtrag *13. Nicht Hybrid!	Kegel sw 21 M12 x 1,5/H17		€ 85,10	
RDKS					

E15J(a), E15UT(a), E15UTN(a), HE15U(a)				Auris I	
		lichtsilber-lackiert		Celsio	CS 656 40 5 14
		lichtsilber-lackiert / mattschwarz-lackiert		Tezzo	TZ 656 40 5 14
		ABE	195/60R16 ❄	6½ J x16 H2 5 x 114,3 ET 40	
		ABE	205/55R16		
		ABE	215/50R16		
MK 040		Celsio: ASC; ASS; CUC; Huf 2.4; Huf 3.4; Huf 3.5; SE1C1; SE1C2; SE1S; TTC; TTS Tezzo: ASC; ASS; CUC; Huf 2.4; Huf 3.4; Huf 3.5; SE1C1; SE1C2; SE1S; TTC			
RDKS					

E15UT(a), E18UM(a)		04/13-		Auris II / Touring Sport	
	Schrägheck, Kombi	154604	7580	TO 515014	Stahl
	1,33 VVT-i (73 kW) / 1,4 D-4D 66 kW)	195/65R15		6 J x15 H2 5x114,3x60 ET 39	
	ab EGBE Nachtrag *14 Touring Sport ab EGBE Nachtrag *15 Nicht Hybrid!	Kegel sw 21 M12 x 1,5		€ 73,50	
ASC; ASS; CUC; CUS; Huf 2.4; Huf 3.4; Huf 3.5; SE1S; SE2S; TTC / OE: Pacific					
RDKS					

E15UT(a), E15UTN(a), HE15U(a)				Auris II / Touring Sport		
		lichtsilber-lackiert / mattschwarz-lackiert		Tezzo	TZ 655 45 5 14	
		Rad nicht frei für Typ E18UM(a)		ABE	195/65R15 ❄	6½ J x15 H2 5 x 114,3 ET 45
				ABE	205/60R15 ❄	
		MK 040		ASC; ASS; CUC; Huf 2.4; Huf 3.4; Huf 3.5; SE1C1; SE1C2; SE1S; TTC		
RDKS						



Auris II / Touring Sport			04/13-	E15UT(a), E18UM(a)	
Stahl	TO 516012	9683	163343	Schrägheck, Kombi	
	6½ J x16 H2	205/55R16		1,33 VVT-i (73 kW)/ 1,6i (97 kW)/ 1,4 D-4D 66 kW)/ 2,0 D-4D (91 kW)	
	5x114,3x60 ET 45				
	€ 84,50	Kegel sw 21 M12 x 1,5		ab EGBE Nachtrag *14 Touring Sport ab EGBE Nachtrag *15 Nicht Hybrid!	
RDKS	ASC; ASS; CUC; CUS; Huf 2.4; Huf 3.4; Huf 3.5; SE1C1; SE1C2; SE2C2; SE1S; SE2S; TTC / OE: Pacific				



Auris II / Touring Sport			E15UT(a), E15UTN(a), HE15U(a)		
MAGNUM	Interio		IN 706 45 5 14	lichtsilber-lackiert / mattschwarz-lackiert	
	7 J x16 EH2+	195/55R16	ABE	Rad nicht frei für Typ E18UM(a)	
	5 x 114,3	205/55R16	ABE		
	ET 45	215/50R16	ABE		
RDKS	ASC; CUC; Huf 2.4; Huf 3.4; Huf 3.5; SE1C1; SE1S			MK 040	IN

Avenis II			05/03-12/08	T25	
Stahl	TO 516003	9955	163410	Schräg-/Stufenheck, Combi	
	6½ J x16 CH	205/55R16		1,8 VVT-i (95 kW)/ 2,0 VVT-i (108 kW)/ 2,4 VVT-i (120 kW)/ 2,0 D-4D (85 kW)	
	5x100x54 ET 45				
	€ 86,10	Kegel sw 21 M12 x 1,5/H17			
RDKS					

Avenis II			07/05-12/08	T25	
Stahl	TO 516006	8015	163412	Schräg-/Stufenheck, Combi	
	6½ J x16 CH	205/55R16		2,2 D-4D (110 kW)/ 2,2 D-CAT (130 kW)	
	5x114,3x60 ET 45				
	€ 86,10	Kegel sw 21 M12 x 1,5/H17		Für Fahrzeuge des Toyota Avenis II mit LK: 114,3 mm	
RDKS					

Avenis III			01/09-2016	T27	
Stahl	TO 516010	7625	163419	Schräg-/Stufenheck, Combi	
	6½ J x16 CH	205/60R16		1,6 VVT-i (97 kW)/ 1,8 VVT-i (108 kW)/ 2,0 VVT-i (112 kW)/ 2,0 D-4D (93/110 kW)	
	5x114,3x60 ET 39				
	€ 86,10	Kegel sw 21 M12 x 1,5/H17			
RDKS	ASC; ASS; CUC; CUS; Huf 2.4; Huf 3.4; Huf 3.5; SE1S; SE2S; TTC / OE: Pacific				

		T27	Avenis III / Avenis Combi III		
		lichtsilber-lackiert	Celsio	CS 656 40 5 14	
		lichtsilber-lackiert / mattschwarz-lackiert	Tezzo	TZ 656 40 5 14	
CS		Bremsanlage beachten	ABE	205/60R16 ❄	6½ J x16 H2
			ABE	215/55R16 ❄	
		MK 040	Celsio: ASC; ASS; CUC; Huf 2.4; Huf 3.4; Huf 3.5; SE1C1; SE1C2; SE1S; TTC; TTS Tezzo: ASC; ASS; CUC; Huf 2.4; Huf 3.4; Huf 3.5; SE1C1; SE1C2; SE1S; TTC		
					RDKS

		T27	Avenis III / Avenis Combi III			
		lichtsilber-lackiert / mattschwarz-lackiert	Interio	IN 706 45 5 14		
		Bremsanlage beachten	ABE	205/60R16 ❄	7 J x16 EH2+	
IN			ABE	215/55R16 ❄		5 x 114,3
			MK 040	ASC; CUC; Huf 2.4; Huf 3.4; Huf 3.5; SE1C1; SE1S		

		2016-	Avenis IV		
Radabbildung in Vorbereitung	Schräg-/Stufenheck, Combi				INFO
	INFO				
					RDKS

		Avenis IV (Neues Modell ab 2016)			
Radabbildung in Vorbereitung					in Vorbereitung
					RDKS

		AB1	07/05-06/14	Aygo	
	Schrägheck	143765	4940	TO 514017	
	1,0i (50 kW)	155/65R14		4½ J x14 H2	4x100x54
				ET 39	
Bis EGBE e11*2001/116*0236*10 TO 514017 auch für Citoën C1 / Peugeot 107.		Kegel sw 17 M12 x 1,5 x 19		€ 58,10	
					RDKS

Aygo		07/14-	AB1	
Stahl	TO 514021	5770	143720	Schrägheck
	4½ J x14 H2 4x100x54 ET 35	165/65R14		1,0 VVT-i (51 kW)
	€ 58,10			Ab EGBE e11*2001/116*0236*11
RDKS				

Aygo		07/14-	AB1	
Stahl	TO 515019	7510	154629	Schrägheck
	4½ J x15 H2 4x100x54 ET 35	165/60R15		1,0 VVT-i (51 kW)
	€ 71,90			Ab EGBE e11*2001/116*0236*11
RDKS				

Corolla		01/02-02/07	E12T, E12U	
Stahl	TO 515009	9145	154665	Schräg-/Stufenheck, Kombi
	6 J x15 H2 4x100x54 ET 45	195/60R15		1,4 VVT-i/ 1,6 VVT-i/ 1,8 VVTL-TS/ 1,4 D-4D/ 2,0 D-4D
	€ 72,40	Kegel sw 21 M12 x 1,5/H17	Nur für in Europa produzierte Fahrzeuge	
RDKS				

Corolla		01/02-02/07	E12J	
Stahl	TO 515010	9285	154666	Schräg-/Stufenheck, Kombi
	6 JJ x15 H2 4x100x54 ET 45	195/60R15		1,4 VVT-i/ 1,6 VVT-i/ 1,8 VVTL-TS/ 1,4 D-4D/ 2,0 D-4D
	€ 72,40	Kegel sw 21 M12 x 1,5/H17	Nur für in Japan produzierte Fahrzeuge	
RDKS				

Corolla		06/14-	E15EJ(a)	
Stahl	TO 516012	9683	163343	Stufenheck
	6½ J x16 H2 5x114,3x60 ET 45	205/55R16		1,33 VVT-i (73 kW)/ 1,6i (97 kW)/ 1,4 D-4D (66 kW)
	€ 84,50			
RDKS		ASC ; ASS ; CUC ; CUS ; Huf 2.4 ; Huf 3.4 ; Huf 3.5 ; SE1C1 ; SE1C2 ; SE1S ; SE2S ; TTC / OE : Pacific		

		E12J1	01/02-06/04	Corolla Verso	
	Van		154666	9285	TO 515010
	1,6 VVT-i (81 kW)/ 1,8 VVT-i (99 kW)/ 2,0 D-4D (66 kW)		195/60R15		6 JJ x15 H2 4x100x54 ET 45
	Nur für in Japan produzierte Fahrzeuge		Kegel sw 21 M12 x 1,5/H17		€ 72,40
RDKS					

		R1	07/04-04/09	Corolla Verso	
	Van		163411	9265	TO 516005
	1,6 VVT-i (81 kW)/ 1,8 VVT-i (95 kW)/ 2,0 D-4D (85 kW)/ 2,2 D-4D (100 kW)		205/55R16		6½ J x16 H2 5x114,3x60 ET 45
			Kegel sw 21 M12 x 1,5/H17		€ 85,10
RDKS					

		H1, H12, H12G	11/95-	Hi-Ace	
Radabbildung in Vorbereitung	Bus, Kasten		968070	8070	*TO 615003
	2,5/2,7 (105kW)/2,5D/2,5TD		195/70R15		6 JJ x15 H2 6x139,7x110 ET 29
	TO 615003 nur für Hi-Ace 4WD.		Kegel sw 21 M12 x 1,5/H17		€ 139,90
RDKS					

		AJ1(a)	02/09-	iQ	
	Schrägheck		154659	7640	TO 515013
	1,0 VVT-i (50 kW)/ 1,4 D-4D (66 kW)		175/65R15		5 J x15 H2 4x100x54 ET 45
			Kegel sw 21 M12 x 1,5		€ 72,40
SE1C1 ; SE1S					
RDKS					

		HW2	03/04-05/09	Prius II	
	Schrägheck		163416	7910	*TO 516008
	1,5i Hybrid		195/55R16		6 J x16 H2 5x100x54 ET 45
	Eintragungspflichtiges Sonderrad! Gutachten kann angefordert werden.		Kegel sw 21 M12 x 1,5/H17		€ 84,50
RDKS					

Prius III		06/09-10/14	XW3(a)	
Stahl	*TO 516008	7910	163416	Schrägheck
	6 J x16 H2	195/60R16		1,8 VVT-i Hybrid (60/73 kW)
	5x100x54			
	ET 45			
	€ 84,50	Kegel sw 21 M12 x 1,5/H17		
RDKS				



Prius III		11/14-	XW3(a)	
Stahl	TO 516014	7911	163431	Schrägheck
	6 J x16 H2	195/60R16		1,8 VVT-i Hybrid (60/73 kW)
	5x100x54			
	ET 45			
	€ 84,50			Für TPMS modifiziertes Rad.
RDKS ASC; ASS; CUC; Huf 2.4; Huf 3.4; Huf 3.5; SE1C1; SE1C2; SE1S; SE2S / OE: Pacific				

Radabbildung
in
Vorbereitung

Prius III		XW3(a), XW3P		
MAGNA	Seismo	SO 706 38 5 00	lichtsilber-lackiert / mattschwarz-lackiert	
	Interio	IN 706 38 5 00	lichtsilber-lackiert / mattschwarz-lackiert	
	7 J x16 H2	195/60R16	TÜV	Auflagen beachten!
	5 x 100	205/55R16	TÜV	
ET 38				
RDKS Seismo: ASC; ASS; CUC; Huf 2.4; Huf 3.4; SE1C2; SE1S; TTC; TTS Interio: ASC; CUC; Huf 2.4; Huf 3.4; Huf 3.5; SE1C1; SE1S				MK 032



SO



IN

Prius+		06/12-	XW4(a)	
Stahl	TO 516010	7625	163419	Van
	6½ J x16 CH	205/60R16		1,8 Hybrid (73 kW)
	5x114,3x60			
	ET 39			
	€ 86,10	Kegel sw 21 M12 x 1,5		
RDKS ASC; ASS; CUC; CUS; Huf 2.4; Huf 3.4; Huf 3.5; SE1S; SE2S; TTC / OE: Pacific				





Prius+		XW3(a), XW4(a)		
MAGNA	Interio	IN 706 45 5 14	lichtsilber-lackiert / mattschwarz-lackiert	
	7J x16 EH2+	205/55R16	ABE	
	5 x 114,3	205/60R16	ABE	
ET 45	215/55R16	ABE		
RDKS ASC; CUC; Huf 2.4; Huf 3.4; Huf 3.5; SE1C1; SE1S				MK 040







IN





IN







		XA3(a)	RAV4 III				
	CS		lichtsilber-lackiert		Celsio	CS 656 40 5 14	MAGNA
			lichtsilber-lackiert / mattschwarz-lackiert		Tezzo	TZ 656 40 5 14	
			ABE	215/70R16 ☼	6½ J x16 H2		
			ABE	225/70R16 ☼		5 x 114,3	
ABE	235/65R16 ☼	ET 40					
MK 040		Celsio: ASC; ASS; CUC; Huf 2.4; Huf 3.4; Huf 3.5; SE1C1; SE1C2; SE1S; TTC; TTS Tezzo: ASC; ASS; CUC; Huf 2.4; Huf 3.4; Huf 3.5; SE1C1; SE1C2; SE1S; TTC				RDKS	

		XA3(a)	RAV4 IV					
	TZ		lichtsilber-lackiert / mattschwarz-lackiert		Tezzo	TZ 757 40 5 14	MAGNA	
			Serienbereifung beachten		ABE	215/65R17 ☼		7½ J x17 H2
			ABE	225/65R17	5 x 114,3			
			ABE	235/60R17	ET 40			
MK 040		ASC; ASS; CUC; Huf 2.4; Huf 3.4; Huf 3.5; SE1C1; SE1C2; SE1S				RDKS		

		XP11(a)	Urban Cruiser				
	SO		lichtsilber-lackiert / mattschwarz-lackiert		Seismo	SO 706 38 5 00	MAGNA
			lichtsilber-lackiert / mattschwarz-lackiert		Interio	IN 706 38 5 00	
			ABE	195/55R16 ☼	7 J x16 H2		
			ABE	195/60R16		5 x 100	
ABE	205/55R16	ET 38					
MK 032		Seismo: ASC; ASS; CUC; Huf 2.4; Huf 3.4; SE1C2; SE1S; TTC; TTS Interio: ASC; CUC; Huf 2.4; Huf 3.4; Huf 3.5; SE1C1; SE1S				RDKS	



		X	09/13-	ProAce		
	Kasten 1,6 D (66 kW)/ 2,0 D (94/120 kW)		163363	7780	PS 616001	Stahl
			215/60R16		7 J x16 H2	
					5x108x65	
					ET 42	
		Kegel sw 17 M12 x 1,25 x 26		€ 90,90	RDKS	
ASC; ASS; CUC; CUS; Huf 2.4; Huf 3.4; Huf 3.5; SE1C1; SE1C2; SE2C1; SE2C2; SE1S; SE2S; TTC; TTS / OE: Schrader 3003						

		AR2	05/09-	Verso		
	Van 1,6 VVT-i (97 kW)/ 1,8 VVT-i (108 kW)/ 2,0 D-4D (93 kW)		163419	7625	TO 516010	Stahl
			205/60R16		6½ J x16 CH	
					5x114,3x60	
					ET 39	
		Kegel sw 21 M12 x 1,5/H17		€ 86,10	RDKS	
ASC; ASS; CUC; CUS; Huf 2.4; Huf 3.4; Huf 3.5; SE1S; SE2S; TTC / OE: Pacific						



Verso				AR2, AR2N	
MAGNA	Celsio		CS 656 40 5 14	lichtsilber-lackiert	
	Tezzo		TZ 656 40 5 14	lichtsilber-lackiert / mattschwarz-lackiert	
	6½ J x16 H2	205/60R16	☼	ABE	
	5 x 114,3	215/55R16	☼	ABE	
ET 40					
RDKS	Celsio: ASC; ASS; CUC; Huf 2.4; Huf 3.4; Huf 3.5; SE1C1; SE1C2; SE1S; TTC; TT5 Tezzo: ASC; ASS; CUC; Huf 2.4; Huf 3.4; Huf 3.5; SE1C1; SE1C2; SE1S; TTC			MK 040	
Verso-S		03/11-	XP12(a)		
Stahl	TO 515017	7210	154649	Mini-Van	
	5½ J x15 CH	185/65R15		1,3i (73 kW)/ 1,4D (66 kW)	
	5x100x54 ET 45				
	€ 77,50	Kegel sw 21 M12 x 1,5/H17			
RDKS	ASC; ASS; CUC; CUS; Huf 2.4; Huf 3.4; Huf 3.5; SE1C1; SE1C2; SE1S; TTC / OE: Pacific				
Yaris		04/99-11/05	P1, P1F		
Stahl	TO 514015	7010	143757	Schrägheck	
	5½ J x14 H2	175/65R14		1,0 Eco (48 kW)/ 1,3i (64 kW)/ 1,4 D-4D C (55 kW)	
	4x100x54 ET 45				
	€ 65,00	Kegel sw 21 M12 x 1,5/H17		FZG-Schein beachten. Einige Ausführungen ausschließlich 13 Zoll. Nicht zulässig für Yaris TS.	
RDKS					
Yaris II		12/05-09/11	XP9, XP9F(a)		
Stahl	TO 514018	5710	143766	Schrägheck	
	5 J x14 CH	165/70R14		1,0 VVT-i (51 kW)	
	4x100x54 ET 39				
	€ 65,00	Kegel sw 21 M12 x 1,5/H17		FZG-Schein beachten, einige Ausführungen nur 15 Zoll.	
RDKS					
Yaris II		12/05-09/11	XP9, XP9F(a)		
Stahl	TO 515011	7890	154668	Schrägheck	
	5½ J x15 CH	185/60R15		1,0 VVT-i (51 kW)/ 1,3 VVT-i (64 kW)/ 1,33 -Dual- VVT-i (74 kW)/ 1,4 D-4D (66 kW)/ 1,8 VVT-i (98 kW)	
	4x100x54 ET 45				
	€ 72,40	Kegel sw 21 M12 x 1,5/H17			
RDKS					

XP13M(a)		10/11-	Yaris III		
	Schrägheck	143769	5975	TO 514020	Stahl
	1.0 VVT-i (51 kW)	175/70R14		5 J x14 H2 4x100x54 ET 39	
		Kegel sw 21 M12 x 1,5/H17		€ 62,90	RDKS
		ASC; ASS; CUC; CUS; Huf 2.4; Huf 3.4; Huf 3.5; SE1C2; SE2C2; SE1S; SE2S; TTC; TTS / OE: Pacific			
XP13M(a)		10/11-	Yaris III		
	Schrägheck	154658	7615	TO 515018	Renner
	1.0 VVT-i (51 kW) / 1.33 Dual-VVT-i (73 kW) / 1.4 D-4D (66 kW) / 1,5 Hybrid (55 kW)	175/65R15		5 J x15 H2 4x100x54 ET 39	
		Kegel sw 21 M12 x 1,5/H17		€ 72,40	RDKS
		ASC; ASS; CUC; CUS; Huf 2.4; Huf 3.4; Huf 3.5; SE1C1; SE1C2; SE2C1; SE2C2; SE1S; SE2S; TTC; TTS			
XP13M (a), XP13N (a)				Yaris III	
		lichtsilber-lackiert / mattschwarz-lackiert		Interio	IN 605 38 4 00
			ABE	175/65R15	
			ABE	185/55R15 *	4 x 100
					ET 38
IN	IN	MK 030	ASC; ASS; CUS; Huf 2.4; Huf 3.4; SE1C1; SE1C2; SE1S; TTC; TTS		RDKS
P2		04/99-02/11	Yaris Verso		
	Van	143757	7010	TO 514015	Stahl
	1,3 C (62 kW) / 1,5 Sol (77 kW) / 1,4 D-4D C (55 kW)	175/65R14		5½ J x14 H2 4x100x54 ET 45	
		Kegel sw 21 M12 x 1,5/H17		€ 65,00	RDKS

Amarok		06/10-	2H, 2HS2	
Stahl	VO 616024	163316	Pick-Up	
	6½ J x16 H2	205R16C	2,0 TDI (90/120/132 kW)	
	5x120x65			
	ET 52			
€ 88,80	Kugel sw 19 M14 x 1,5 x 36			
RDKS	CUC; SE1C1; SE2C1; SE2C2; SE1S; SE2S			



Amarok		2H, 2HS2		
MAGNA	Tezzo	TZ 807 50 5 20	lichtsilber-lackiert / mattschwarz-lackiert	
	8 J x17 H2	245/65R17	ABE	
	5 x 120	255/60R17	ABE	
	ET 50	255/65R17	ABE	
RDKS	ASC; ASS; CUC; Huf 2.4; Huf 3.4; Huf 3.5; SE1C1; SE1C2; SE1S; TTC		Serie	
			TZ	

Beetle I (New Beetle)		10/98-09/11	9C, 1Y	
Stahl	VO 515011	8380	152503	Schrägheck, Cabrio
	6 J x15 H2	195/65R15		1,4 16V/ 1,6/ 2,0/ 1,8 5V Turbo/ 1,9 Tdi
	5x100x57			
	ET 38			
€ 64,50	Kugel sw 17 M14 x 1,5 x 27			
RDKS				

Beetle I (New Beetle)		9C, 1Y (Cabrio)		
MAGNA	Celsio	CS 655 35 5 00	lichtsilber-lackiert	
	Tezzo	TZ 655 35 5 00	lichtsilber-lackiert / mattschwarz-lackiert	
	6½ J x15 H2	195/60R15	ABE	
	5 x 100	195/65R15	ABE	
ET 35	205/55R15	ABE		
RDKS	Celsio: ASC; ASS; CUC; Huf 2.4; Huf 3.4; Huf 3.5; SE1C1; SE1C2; SE1S; TTC; TTS Tezzo: ASC; ASS; CUC; Huf 2.4; Huf 3.4; Huf 3.5; SE1C1; SE1C2; SE1S; TTC		MK 303	
			CS	

Beetle I (New Beetle)		10/98-09/11	9C, 1Y	
Stahl	VO 516005	9680	162701	Schrägheck, Cabrio
	6½ J x16 H2	205/55R16		1,4 16V/ 1,6/ 2,0/ 1,8 5V Turbo/ 2,3 V5/ 1,9 TDi
	5x100x57			
	ET 42			
€ 82,40	Kugel sw 17 M14 x 1,5 x 27			
RDKS				

		16	10/11-	Beetle II	
	Schrägheck, Cabrio	163908	9173	VO 516033	Renner
	1,2 TSI (77 kW)/ 1,4 TSI (114 kW)/ 2,0 TSI (147 kW)/ 1,6 TDI (77 kW)/ 2,0 TDI (103 kW)	205/60R16 215/60R16		6½ J x16 H2 5x112x57 ET 44	
		Kugel sw 17 M14 x 1,5 x 27		€ 82,90	RDKS
		ASC; ASS; CUC; Huf 2.4; Huf 3.4; Huf 3.5; SE1C1; SE1C2; SE2C1; SE2C2; SE1S; SE2S			

		16	Beetle II			
		lichtsilber-lackiert / mattschwarz-lackiert	Interio	IN 706 45 5 12		MAGMA
			ABE	205/60R16	7 J x16 EH2+ 5 x 112 ET 45	
			ABE	215/60R16		
		MK 306	ASC; CUC; Huf 2.4; Huf 3.4; Huf 3.5; SE1C1; SE1S			

		Beetle Dune			
Radabbildung in Vorbereitung					MAGMA
				in Vorbereitung	
					RDKS



		1J	10/98-07/05	Bora	
	Stufenheck, Variant	152503	8380	VO 515011	Stahl
	1,4i/1,6i (74 kW)/1,8i/2,0i (85 kW)/ 2,3 V5 (110 kW)/1,9TDI (66/74/81/85 kW)	195/65R15 M+S		6 J x15 H2 5x100x57 ET 38	
	Variant ab 07/99-	Kugel sw 17 M14 x 1,5 x 27		€ 64,50	
					RDKS

		1J	10/98-07/05	Bora	
	Stufenheck, Variant	162701	9680	VO 516005	Stahl
	1,4i/1,6i/1,8i/2,0i/2,3 V5/V6 4Motion/1,9TDI	205/55R16		6½ J x16 H2 5x100x57 ET 42	
	Variant ab 07/99-	Kugel sw 17 M14 x 1,5 x 27		€ 82,40	
					RDKS







Caddy		01/04-06/15	2KN	
Renner	VO 615036	154106	Stadtlieferwagen	
	6 J x15 H2	195/65R15	1,2 TSI (63/77 kW)/ 1,4i (55/59 kW)/ 1,6i (75 kW)/ 1,6TDI (55/65/75 kW)/ 1,9TDI (55/77 kW)/ 2,0TDI (81 kW)/ 2,0SDI (51 kW)/ 1,6 BiFuel (72/75 kW)/ 2,0 EcoFuel (80 kW)	
	5x112x57			
	ET 47			
€ 70,80	Kugel sw 17 M14 x 1,5 x 27	Ersetzt VO 615034.		
RDKS	CUC; SE1C1; SE1C2; SE2C1; SE1S; SE2S			





Caddy		10/07-06/15	2KN	
Stahl	VO 616021	9702	164002	Stadtlieferwagen
	6 J x16 H2	205/55R16	1,2 TSI (63/77 kW)/ 1,4i (55/59 kW)/ 1,6i (75 kW)/ 1,6TDI (55/65/75 kW)/ 1,9TDI (55/77 kW)/ 2,0SDI (51 kW)/ 2,0TDI (81/103 kW)/ 1,6 BiFuel (72/75 kW)/ 2,0 EcoFuel (80 kW)	
	5x112x57			
	ET 50			
€ 79,80	Kugel sw 17 M14 x 1,5 x 27			
RDKS	ASC; CUC; Huf2.4; Huf3.4; SE1C1; SE2C1; SE1S; SE2S			

Caddy Life		06/04-06/15	2K	
Renner	VO 615036	154106	Kombi	
	6 J x15 H2	195/65R15	1,2 TSI (63/77 kW)/ 1,4i (55/59 kW)/ 1,6i (75 kW)/ 1,6TDI (55/65/75 kW)/ 1,9TDI (55/77 kW)/ 2,0TDI (81 kW)/ 1,9TDI 4motion (77 kW)/ 2,0SDI (51 kW)/ 1,6 BiFuel (72/75 kW)/ 2,0 EcoFuel (80 kW)	
	5x112x57			
	ET 47			
€ 70,80	Kugel sw 17 M14 x 1,5 x 27	Ersetzt VO 615034.		
RDKS	CUC; SE1C1; SE1C2; SE2C1; SE1S; SE2S			



Caddy / Caddy Life / Caddy Maxi			2K, 2KN			
MAGNA	Interio	IN 605 45 5 12	lichtsilber-lackiert / mattschwarz-lackiert			
	6 J x15 H2	195/65R15 *	ABE			
	5 x 112					
	ET 45					
RDKS	ASC; ASS; CUS; Huf 2.4; Huf 3.4; SE1C1; SE1C2; SE1S; TTC; TTS		MK 306	IN	IN	

Caddy Life		10/07-06/15	2K	
Stahl	VO 616021	9702	164002	Kombi
	6 J x16 H2	205/55R16	1,2 TSI (63/77 kW)/ 1,4i (55/59 kW)/ 1,6i (75 kW)/ 1,6TDI (55/65/75 kW)/ 1,9TDI (55/77 kW)/ 1,9TDI 4motion (77 kW)/ 2,0SDI (51 kW)/ 2,0TDI (81/103 kW)/ 1,6 BiFuel (72/75 kW)/ 2,0 EcoFuel (80 kW)	
	5x112x57			
	ET 50			
€ 79,80	Kugel sw 17 M14 x 1,5 x 27			
RDKS	ASC; CUC; Huf 2.4; Huf 3.4; SE1C1; SE2C1; SE1S; SE2S			

		2K, 2KN	Caddy / Caddy Life / Caddy Maxi			
 <p>CS</p>	 <p>TZ</p>	lichtsilber-lackiert		Celsio	CS 656 50 5 12	MAGNA
		lichtsilber-lackiert / mattschwarz-lackiert		Tezzo	TZ 656 50 5 12	
			ABE	205/55R16	6½ J x16 H2	
					5 x 112	
		MK 306	Celsio: ASC; ASS; CUC; Huf 2.4; Huf 3.4; Huf 3.5; SE1C1; SE1C2; SE1S; TTC; TTS Tezzo: ASC; ASS; CUC; Huf 2.4; Huf 3.4; Huf 3.5; SE1C1; SE1C2; SE1S; TTC		ET 50	RDKS
		2KN	01/08-06/15	Caddy Maxi		
	Stadtlieferwagen	154106		VO 615036	Renner	
	1,2 TSI (63/77 kW)/ 1,6i (75 kW)/ 1,6 TDI (55/65/75 kW)/ 1,9 TDI (77 kW)/ 1,9 TDI 4motion (77 kW)/ 2,0 TDI (81 kW)/ 1,6 BiFuel (72/75 kW)/ 2,0 EcoFuel (80 kW)	195/65R15		6 J x15 H2		
	Ersetzt VO 615034.		5x112x57			
		Kugel sw 17 M14 x 1,5 x 27	€ 70,80			
		CUC; SE1C1; SE1C2; SE2C1; SE1S; SE2S		RDKS		
		2KN	01/08-06/15	Caddy Maxi		
	Stadtlieferwagen	164002	9702	VO 616021	Stahl	
	1,2 TSI (63/77 kW)/ 1,6i (75 kW)/ 1,6 TDI (55/65/75 kW)/ 1,9 TDI (77 kW)/ 1,9 TDI 4motion (77 kW)/ 2,0 TDI (81/103 kW)/ 1,6 BiFuel (72/75 kW)/ 2,0 EcoFuel (80 kW)	205/55R16		6 J x16 H2		
			5x112x57			
		Kugel sw 17 M14 x 1,5 x 27	€ 79,80			
		ASC; CUC; Huf 2.4; Huf 3.4; SE1C1; SE2C1; SE1S; SE2S		RDKS		
		2K	10/07-06/15	Caddy Maxi Life		
	Kombi	154106		VO 615036	Renner	
	1,2 TSI (63/77 kW)/ 1,6i (75 kW)/ 1,6 TDI (55/65/75 kW)/ 1,9 TDI (77 kW)/ 1,9 TDI 4motion (77 kW)/ 2,0 TDI (81 kW)/ 1,6 BiFuel (72/75 kW)/ 2,0 EcoFuel (80 kW)	195/65R15		6 J x15 H2		
	Ersetzt VO 615034.		5x112x57			
		Kugel sw 17 M14 x 1,5 x 27	€ 70,80			
		CUC; SE1C1; SE1C2; SE2C1; SE1S; SE2S		RDKS		
		2K, 2KN	07/15-	Caddy		
	Kombi, Kasten	154106		VO 615036	Renner	
	1,2 TSI (62 kW)/ 1,4 TSI (92 kW)/ 1,6 TDI (55/75 kW)/ 2,0 TDI (55/75/81/90/103/110 kW)/ 1,4 TGI (81 kW)/ 4motion	195/65R15		6 J x15 H2		
			5x112x57			
			€ 70,80			
		CUC; SE1C1; SE1C2; SE2C1; SE1S; SE2S		RDKS		

Caddy		07/15-	2K, 2KN
Stahl	VO 616021	9702	164002
	6 J x16 H2	205/55R16	
	5x112x57		
	ET 50		
€ 79,80			
RDKS	ASC; CUC; Huf 2.4; Huf 3.4; SE1C1; SE2C1; SE1S; SE2S		
			
Caddy Maxi Life		10/07-06/15	2K
Stahl	VO 616021	9702	164002
	6 J x16 H2	205/55R16	
	5x112x57		
	ET 50		
€ 79,80		Kugel sw 17 M14 x 1,5 x 27	
RDKS	ASC; CUC; Huf 2.4; Huf 3.4; SE1C1; SE2C1; SE1S; SE2S		
			
Crafter		06/06-	2EC1, 2EKE1, 2EKE2, 2FJE1, 2FJE2
Stahl	ME 616037		163398
	5½ J x16 H2	205/75R16C	
	6x130x84		
	ET 51		
€ 92,40		Rad für Singlebereifung.	
RDKS	OE: VDO A2CS9511309		
Radabbildung in Vorbereitung			
Crafter		06/06-	2EKE2, 2EKZ, 2FJE2, 2FJZ
Stahl	ME 616036	7870	163373
	5½ J x16 H2	195/75R16C	
	6x205x161	205/75R16C	
	ET 109,5		
€ 142,80			
RDKS			Rad für Zwillingsbereifung bis 5,0t Gesamtgewicht. Auch Vorderachse. FZG-Schein muss unbedingt beachtet werden: Je nach Ausführung und Motorisierung sind unterschiedliche Reifenabmessungen vorgeschrieben.
			
Crafter		06/06-	2EC1, 2EC2, 2EKE1, 2EKE2, 2EKZ, 2FJE1, 2FJE2, 2FJZ
Stahl	ME 616013	9487	163323
	6½ J x16 H2	205/75R16C	
	6x130x84	225/75R16C	
	ET 62	235/65R16C	
€ 92,40		Kugel sw 19 M14 x 1,5 x 34	
RDKS	CUC; Huf 2.4; Huf 3.4 / OE: VDO A2CS9511309		FZG-Schein muss unbedingt beachtet werden: Je nach Ausführung und Motorisierung sind unterschiedliche Reifenabmessungen vorgeschrieben.
			





		1F	06/06-06/15	Eos	
	Cabrio	163904	8425	VO 516025	Renner
	1,4 TSI (90/118 kW)/ 1,6 FSI (85 kW)/ 2,0 FSI (110 kW)/ 2,0 TFSI (147 kW)/ 2,0 TDI-PD (103 kW)	215/55R16 205/55R16 M+S		6½ J x16 H2 5x112x57 ET 42	
			Kugel sw 17 M14 x 1,5 x 27	€ 80,30	RDKS
			ASC; ASS; CUC; Huf 2.4; Huf 3.4; Huf 3.5; SE1C1; SE1C2; SE2C1; SE2C2; SE1S; SE2S		



		1F	Eos				
	CS		MK 306	lichtsilber-lackiert	Celsio	CS 706 38 5 12	MAGMA
				lichtsilber-lackiert / mattschwarz-lackiert	Interio	IN 706 38 5 12	
				ABE	205/55R16 M+S ❄	7 J x16 EH2+	
				ABE	215/55R16 ❄	5 x 112 ET 38	
				Celsio: ASC; CUC; Huf 3.4; Huf 3.5; SE1C1; SE1S Interio: ASC; CUC; Huf 2.4; Huf 3.4; Huf 3.5; SE1C1; SE1S	RDKS		

		5 Z	04/05-04/11	Fox	
	Steilheck	143502	5210	VO 514015	Renner
		1,2i (40 kW)/ 1,4i-16V (55 kW)/ 1,4 TDI (51 kW)	165/70R14	5 J x14 H2 5x100x57 ET 35	
			Kugel sw 17 M14 x 1,5 x 27	€ 56,00	RDKS
			SE1S		

		5 Z	04/05-04/11	Fox	
	Steilheck	143402	7280	VO 514016	Stahl
		1,2i (40 kW)/ 1,4i-16V (55 kW)/ 1,4 TDI (51 kW)	185/60R14	6 J x14 H2 5x100x57 ET 43	
	1,2i (40 kW) nur mit Servolenkung. Bei 1,2i (40 kW) ohne Servolenkung nur VO 514015 zulässig!		Kugel sw 17 M14 x 1,5 x 27	€ 58,10	RDKS

		5 Z	04/05-04/11	Fox	
	Steilheck	152506	9545	VO 515020	Stahl
		1,2i (40 kW)/ 1,4i-16V (55 kW)/ 1,4 TDI (51 kW)	195/55R15	6 J x15 H2 5x100x57 ET 43	
	1,2i (40 kW) nur mit Servolenkung. Bei 1,2i (40 kW) ohne Servolenkung nur VO 514015 zulässig! Keine Schneekettenmontage zulässig.		Kugel sw 17 M14 x 1,5 x 27	€ 64,50	RDKS

Golf IV			10/97-09/03	1J	
Stahl	VO 515011	8380	152503	Schrägheck	
	6 J x15 H2	195/65R15		1,4i/ 1,6i/ 1,8i /1,8T/2,0i /2,3 V5 GTI/	
	5x100x57			1,9SDI/1,9TDI/ 1,9 TDI-PD/4Motion	
	ET 38				
	€ 64,50	Kugel sw 17 M14 x 1,5 x 27			
RDKS					
Golf IV			10/97-09/03	1J	
Stahl	VO 516005	9680	162701	Schrägheck	
	6½ J x16 H2	205/55R16		1,4i/ 1,6i/ 1,8i /1,8T/2,0i /2,3 V5 GTI/ 2,8 V6/	
	5x100x57			1,9SDI/1,9TDI/ 1,9 TDI-PD/4Motion	
	ET 42				
	€ 82,40	Kugel sw 17 M14 x 1,5 x 27			
RDKS					
Golf IV Variant			07/99-05/06	1J	
Stahl	VO 515011	8380	152503	Variant	
	6 J x15 H2	195/65R15		1,4i/ 1,6i/ 1,8i /1,8T/2,0i /2,3 V5 GTI/	
	5x100x57			1,9SDI/1,9TDI/ 1,9 TDI-PD/4Motion	
	ET 38				
	€ 64,50	Kugel sw 17 M14 x 1,5 x 27			
RDKS					
Golf IV Variant			07/99-05/06	1J	
Stahl	VO 516005	9680	162701	Variant	
	6½ J x16 H2	205/55R16		1,4i/ 1,6i/ 1,8i /1,8T/2,0i /2,3 V5 GTI/	
	5x100x57			1,9SDI/1,9TDI/ 1,9 TDI-PD/4Motion	
	ET 42				
	€ 82,40	Kugel sw 17 M14 x 1,5 x 27			
RDKS					
Golf V			10/03-09/08	1K, 1KM	
Renner	VO 515024	9165	154104	Schrägheck, Variant	
	6 J x15 H2	195/65R15		1,4 16V/1,4 FSI/TSI (55/59/66/103 kW)/ 1,6i (75 kW)/ 1,6 FSI (85	
	5x112x57	205/60R15		kW)/ 2,0 FSI (110 kW)/ 2,0 SDI (55 kW)/ 1,9 TDI (66/77 kW)/ 2,0	
	ET 47			TDI (103 kW)	
	€ 63,90	Kugel sw 17 M14 x 1,5 x 27		205/60R15 nicht für 2,0 FSI (110 kW) zulässig! Variant ab 05/07-	
RDKS					

		1K, 1KM	Golf V		
		lichtsilber-lackiert / mattschwarz-lackiert		Interio	IN 605 45 5 12
			ABE	195/65R15 ❄	
			ABE	205/60R15	5 x 112
					ET 45
IN	IN	MK 306	ASC ; ASS ; CUS ; Huf 2.4 ; Huf 3.4 ; SE1C1 ; SE1C2 ; SE1S ; TTC ; TTS		RDKS

KRONPRINZ
MAGNA

		1K, 1KM	10/03-09/08	Golf V	
	Schrägheck, Variant	164001	9535	AD 516012	
	1,4 16V/1,4 FSI/1,4 TSI (55/59/66/103/118 kW)/ 1,6i (75 kW)/ 1,6 FSI (85 kW)/ 2,0 FSI (110 kW)/ 2,0 SDI (55 kW)/ 1,9 TDI/ 2,0 TDI (103/125 kW)	205/55R16 M+S		6 J x16 H2	
	Variant ab 05/07-	Kugel sw 17 M14 x 1,5 x 27		5x112x57	
				ET 50	
				€ 74,50	
				RDKS	

Renner

		1K, 1KM	10/03-09/08	Golf V	
	Schrägheck, Variant	163902	9915	VO 516015	
	1,4 16V/1,4 FSI/1,4 TSI (55/59/66/103/118 kW)/ 1,6i (75 kW)/ 1,6 FSI (85 kW)/ 2,0 FSI (110 kW)/ 2,0 SDI (55 kW)/ 1,9 TDI/ 2,0 TDI (103/125 kW)	205/55R16		6½ J x16 H2	
	Keine Schneeketten zulässig! Variant ab 05/07-	Kugel sw 17 M14 x 1,5 x 27		5x112x57	
				ET 50	
				€ 75,00	
				RDKS	

Renner

		1K, 1KM	Golf V		
		lichtsilber-lackiert		Celsio	CS 656 50 5 12
		lichtsilber-lackiert / mattschwarz-lackiert		Tezzo	
CS	TZ	Rad auch für Golf GTI 147 kW	ABE	205/55R16 ❄	6½ J x16 H2
					5 x 112
					ET 50
		MK 306	Celsio: ASC ; ASS ; CUC ; Huf 2.4 ; Huf 3.4 ; Huf 3.5 ; SE1C1 ; SE1C2 ; SE1S ; TTC ; TTS Tezzo: ASC ; ASS ; CUC ; Huf 2.4 ; Huf 3.4 ; Huf 3.5 ; SE1C1 ; SE1C2 ; SE1S ; TTC		RDKS



KRONPRINZ
MAGNA

		1K	12/04-05/09	Golf V GTI	
	Schrägheck	164001	9535	AD 516012	
	2,0 (147 kW)	205/55R16 M+S		6 J x16 H2	
		Kugel sw 17 M14 x 1,5 x 27		5x112x57	
				ET 50	
				€ 74,50	
				RDKS	

Renner

Golf V GTI			12/04-05/09	1K	
Renner	VO 516015	9915	163902	Schrägheck	
	6½ Jx16 H2	205/55R16		2,0 (147 kW)	
	5x112x57 ET 50				
€ 75,00		Kugel sw 17 M14 x 1,5 x 27			
RDKS					

Golf V Plus / Golf VI Plus			02/05-03/14	1KP	
Renner	VO 515024	9165	154104	Mini-Van	
	6 Jx15 H2	195/65R15	1,2 TSI (63/77 kW)/ 1,4 16V/ 1,4 FSI/1,4 TSI (55/59/66/90/103 kW)/		
	5x112x57 ET 47	205/60R15	1,6i (75 kW)/ 1,6 FSI (85 kW)/ 2,0 FSI (110 kW)/ 1,6 TDI/ 1,9 TDI/ 2,0 TDI (103 kW)/ Bi-Fuel (72/75 kW)		
€ 63,90		Kugel sw 17 M14 x 1,5 x 27			
RDKS					

Golf V Plus, Golf VI Plus, Golf VI Cross				1KP			
MAGNA	Interio		IN 605 45 5 12	lichtsilber-lackiert / mattschwarz-lackiert			
	6 Jx15 H2	195/65R15	⊗	ABE			
	5 x 112 ET 45	205/60R15		ABE			
RDKS		ASC; ASS; CUS; Huf 2.4; Huf 3.4; SE1C1; SE1C2; SE1S; TTC; TTS		MK 306	IN	IN	

Golf V Plus / Golf VI Plus			02/05-03/14	1KP	
Renner	AD 516012	9535	164001	Mini-Van	
	6 Jx16 H2	205/55R16 M+S		1,2 TSI (63/77 kW)/ 1,4 16V/ 1,4 FSI/ 1,4 TSI (55/59/66/90/103/118 kW)/ 1,6i (75 kW)/ 1,6 FSI (85 kW)/ 2,0 FSI (110 kW)/ 1,6 TDI/ 1,9 TDI/ 2,0 TDI (103/125 kW)/ Bi-Fuel (72/75 kW)	
	5x112x57 ET 50				
€ 74,50		Kugel sw 17 M14 x 1,5 x 27			
RDKS					

Golf V Plus / Golf VI Plus			02/05-03/14	1KP	
Renner	VO 516015	9915	163902	Mini-Van	
	6½ Jx16 H2	205/55R16		1,2 TSI (63/77 kW)/ 1,4 16V/ 1,4 FSI/ 1,4 TSI (55/59/66/90/103/118 kW)/ 1,6i (75 kW)/ 1,6 FSI (85 kW)/ 2,0 FSI (110 kW)/ 1,6 TDI/ 1,9 TDI/ 2,0 TDI (103/125 kW)/ Bi-Fuel (72/75 kW)	
	5x112x57 ET 50				
€ 75,00		Kugel sw 17 M14 x 1,5 x 27			
RDKS					

		1KP	Golf V Plus, Golf VI Plus, Golf VI Cross	
	CS	TZ	lichtsilber-lackiert	Celsio CS 656 50 5 12
			lichtsilber-lackiert / mattschwarz-lackiert	Tezzo TZ 656 50 5 12
			ABE	205/55R16 * 6½ J x16 H2
				5 x 112
				ET 50
		MK 306	Celsio: ASC; ASS; CUC; Huf 2.4; Huf 3.4; Huf 3.5; SE1C1; SE1C2; SE1S; TTC; TTS Tezzo: ASC; ASS; CUC; Huf 2.4; Huf 3.4; Huf 3.5; SE1C1; SE1C2; SE1S; TTC	

MAGNA

RDKS

		1K	10/08-10/12	Golf VI
	Renner	Schrägheck	154104	9165
		1,2 TSI (63/77 kW)/ 1,4i (59 kW)/ 1,6i (75 kW)/ 1,4 TSI (90 kW)/ 1,6 TDI (77 kW)/ 2,0 TDI (81/103 kW)/ 1,6 Bi-Fuel (72/75 kW) Nicht 1,4 TSI (118 kW)!	195/65R15 205/60R15	VO 515024 6 J x15 H2 5x112x57 ET 47
			Kugel sw 17 M14 x 1,5 x 27	€ 63,90

Renner

RDKS

		1K, 1KM	Golf VI / Golf VI Variant	
	CS		lichtsilber-lackiert	Celsio CS 655 47 5 12
		MK 306	ABE	195/65R15 * 6½ J x15 H2
			ABE	205/60R15
			ABE	215/60R15
			ASC; ASS; CUC; Huf 2.4; Huf 3.4; Huf 3.5; SE1C1; SE1C2; SE1S; TTC; TTS	

MAGNA

RDKS

		1K	10/08-10/12	Golf VI
	Renner	Schrägheck	164001	9535
		1,2 TSI (63/77 kW)/ 1,4i (59 kW)/ 1,6i (75 kW)/ 1,4 TSI (90/118 kW)/ 1,6 TDI (77 kW)/ 2,0 TDI (81/103 kW)/ 1,6 Bi-Fuel (72/75 kW)/ 4-Motion	205/55R16 M+S	AD 516012 6 J x16 H2 5x112x57 ET 50
			Kugel sw 17 M14 x 1,5 x 27	€ 74,50

Renner

RDKS

		1K	10/08-10/12	Golf VI
	Renner	Schrägheck	163902	9915
		1,2 TSI (63/77 kW)/ 1,4i (59 kW)/ 1,6i (75 kW)/ 1,4 TSI (90/118 kW)/ 1,6 TDI (77 kW)/ 2,0 TDI (81/103 kW)/ 1,6 Bi-Fuel (72/75 kW)/ 4-Motion	205/55R16	VO 516015 6½ J x16 H2 5x112x57 ET 50
			Kugel sw 17 M14 x 1,5 x 27	€ 75,00

Renner

RDKS

Golf VI / Golf VI Variant			1K, 1KM	
MAGNA	Celsio	CS 706 45 5 12	lichtsilber-lackiert	
	Interio	IN 706 45 5 12	lichtsilber-lackiert / mattschwarz-lackiert	
	7 J x16 EH2+	205/55R16 M+S ☼	ABE	 
	5 x 112			
ET 45				
RDKS	Celsio: ASC; CUC; Huf 3.4; Huf 3.5; SE1C1; SE15 Interio: ASC; CUC; Huf 2.4; Huf 3.4; Huf 3.5; SE1C1; SE15		MK 306	CS IN

Golf VI / Golf VI Variant			1K, 1KM	
MAGNA	Tezzo	TZ 757 50 5 12	lichtsilber-lackiert / mattschwarz-lackiert	
	7½ J x17 H2	205/50R17	ABE	 
	5 x 112	215/45R17	ABE	
	ET 50	225/45R17	ABE	
RDKS	ASC; ASS; CUC; Huf 2.4; Huf 3.4; Huf 3.5; SE1C1; SE1C2; SE15		MK 306	TZ TZ

Golf VI Cross		06/10-	1KP
Renner	VO 515024	9165	154104
	6 J x15 H2	195/65R15	SUV 1,2 TSI (77 kW) / 1,4 TSI (90 kW) / 2,0 TDI (103 kW)
	5x112x57	205/60R15	
	ET 47		
€ 63,90	Kugel sw 17 M14 x 1,5 x 27		
RDKS	CUC; SE1C1; SE2C1; SE15; SE25		



Golf VI Cross		06/10-	1KP
Renner	AD 516012	9535	164001
	6 J x16 H2	205/55R16 M+S	SUV 1,2 TSI (77 kW) / 1,4 TSI (90/118 kW) / 2,0 TDI (103 kW)
	5x112x57		
	ET 50		
€ 74,50	Kugel sw 17 M14 x 1,5 x 27		
RDKS			



Golf VI Cross		06/10-	1KP
Renner	VO 516015	9915	163902
	6½ J x16 H2	205/55R16	SUV 1,2 TSI (77 kW) / 1,4 TSI (90/118 kW) / 2,0 TDI (103 kW)
	5x112x57		
	ET 50		
€ 75,00	Kugel sw 17 M14 x 1,5 x 27		
RDKS	ASC; ASS; CUC; Huf 2.4; Huf 3.4; Huf 3.5; SE1C1; SE1C2; SE2C1; SE2C2; SE15; SE25		

		1K	06/11-	Golf VI Cabrio		
	Cabrio	154104	9165	VO 515024	Renner	
	1,2 TSI (77 kW) / 1,6 TDI (77 kW) / 2,0 TDI (103 kW)	195/65R15		6 J x15 H2		
		205/60R15		5x112x57 ET 47		
			Kugel sw 17 M14 x 1,5 x 27	€ 63,90		
		CUC; SE1C1; SE2C1; SE1S; SE2S				RDKS

		1K	06/11-	Golf VI Cabrio		
	Cabrio	164001	9535	AD 516012	Renner	
	1,2 TSI (77 kW) / 1,4 TSI (118 kW) / 1,6 TDI (77 kW) / 2,0 TDI (103 kW)	205/55R16		6 J x16 H2		
				5x112x57 ET 50		
			Kugel sw 17 M14 x 1,5 x 27	€ 74,50		
						RDKS

		1K	06/11-	Golf VI Cabrio		
	Cabrio	163902	9915	VO 516015	Renner	
	1,2 TSI (77 kW) / 1,4 TSI (118 kW) / 1,6 TDI (77 kW) / 2,0 TDI (103 kW)	205/55R16		6½ J x16 H2		
				5x112x57 ET 50		
			Kugel sw 17 M14 x 1,5 x 27	€ 75,00		
		ASC; ASS; CUC; Huf 2.4; Huf 3.4; Huf 3.5; SE1C1; SE1C2; SE2C1; SE2C2; SE1S; SE2S				RDKS

		1K	Golf VI Cabrio			
	CS		TZ	lichtsilber-lackiert	Celsio	CS 656 50 5 12
				lichtsilber-lackiert / mattschwarz-lackiert	Tezzo	TZ 656 50 5 12
				ABE	205/50R16 ❄️	6½ J x16 H2
				ABE	205/55R16	5 x 112
				ABE	215/50R16	ET 50
		MK 306	Celsio: ASC; ASS; CUC; Huf 2.4; Huf 3.4; Huf 3.5; SE1C1; SE1C2; SE1S; TTC; TTS Tezzo: ASC; ASS; CUC; Huf 2.4; Huf 3.4; Huf 3.5; SE1C1; SE1C2; SE1S; TTC			RDKS

		1K	Golf VI Cabrio			
	TZ		TZ	lichtsilber-lackiert / mattschwarz-lackiert	Tezzo	TZ 757 50 5 12
				ABE	205/50R17	7½ J x17 H2
				ABE	215/45R17	5 x 112
				ABE	225/45R17	ET 50
						MK 306

**KRONPRINZ
MAGMA**

**KRONPRINZ
MAGMA**

Golf VI GTD / GTI			06/09-04/13	1K	
Renner	AD 516012	9535	164001	Schrägheck, Cabrio	
	6 J x16 H2	205/55R16 M+S		2,0 GTI (155 kW)/ 2,0 GTD (125 kW)	
	5x112x57				
	ET 50				
	€ 74,50	Kugel sw 17 M14 x 1,5 x 27		Nicht GTI (173 kW)!	
RDKS					

Golf VI GTD / GTI			06/09-04/13	1K	
Renner	VO 516015	9915	163902	Schrägheck, Cabrio	
	6½ J x16 H2	205/55R16		2,0 GTI (155 kW)/ 2,0 GTD (125 kW)	
	5x112x57				
	ET 50				
	€ 75,00	Kugel sw 17 M14 x 1,5 x 27		Nicht GTI (173 kW)!	
RDKS					

Golf VI Variant			06/09-07/13	1KM	
Renner	VO 515024	9165	154104	Variant	
	6 J x15 H2	195/65R15			
	5x112x57	205/60R15			
	ET 47				
	€ 63,90	Kugel sw 17 M14 x 1,5 x 27			
RDKS					



Golf VI Variant			06/09-07/13	1KM	
Renner	AD 516012	9535	164001	Variant	
	6 J x16 H2	205/55R16 M+S		1,2 TSI (63/77 kW)/ 1,4i (59 kW)/ 1,4 TSI (90/118 kW)/	
	5x112x57			1,6 TDI (77 kW)/ 2,0 TDI (103 kW)/ 4-Motion	
	ET 50				
	€ 74,50	Kugel sw 17 M14 x 1,5 x 27			
RDKS					

Golf VI Variant			06/09-07/13	1KM	
Renner	VO 516015	9915	163902	Variant	
	6½ J x16 H2	205/55R16		1,2 TSI (63/77 kW)/ 1,4i (59 kW)/ 1,4 TSI (90/118 kW)/	
	5x112x57			1,6 TDI (77 kW)/ 2,0 TDI (103 kW)/ 4-Motion	
	ET 50				
	€ 75,00	Kugel sw 17 M14 x 1,5 x 27			
RDKS					

		AU	11/12-	Golf VII	
	Schrägheck		155801	7755	VO 515031
	1,0 TSI (85 kW) / 1,2 TSI (63/77/81 kW) / 1,4 TSI (90/92/103/110 kW) / 1,6 TDI (66/77/81 kW) / 2,0 TDI (103/110 kW) / 1,4 TGI (81 kW) / e-Golf (85 kW)		195/65R15		6 J x15 H2 5x112x57 ET 43
	Einige Ausführungen nur 16 Zoll! Nicht in Verbindung mit DCC (adaptive Fahrwerksregelung).		Kugel sw 17 M14 x 1,5 x 27		€ 67,10
			ASC; ASS; CUC; Huf 3.5; SE1C1; SE1C2; SE2C1; SE1S; SE2S		

Renner

RDKS

		AU, AUV	Golf VII, Golf VII Variant, Golf VII Sportsvan			
			lichtsilber-lackiert / mattschwarz-lackiert		Interio	IN 605 45 5 12
		Einige Ausführungen nur 16 Zoll! Nicht in Verbindung mit DCC (adaptive Fahrwerksregelung).	ABE	195/65R15 ❄	6 J x15 H2	
			ABE	205/60R15 ❄	5 x 112 ET 45	
IN	IN	MK 306	ASC; ASS; CUS; Huf 2.4; Huf 3.4; SE1C1; SE1C2; SE1S; TTC; TTS			

KRONPRINZ
MAGMA

RDKS

		AU	11/12-	Golf VII	
	Schrägheck		165601	8247	VO 516034
	1,0 TSI (85 kW) / 1,2 TSI (63/77/81 kW) / 1,4 TSI (90/92/103/110 kW) / 1,6 TDI (66/77/81 kW) / 2,0 TDI (103/110/132 kW) / 1,4 TGI (81 kW) / e-Golf (85 kW)		205/55R16 M+S		6 J x16 H2 5x112x57 ET 48
			Kugel sw 17 M14 x 1,5 x 27		€ 78,20
			ASC; CUC; Huf 2.4; Huf 3.4; Huf 3.5; SE1C1; SE1C2; SE2C1; SE2C2; SE1S; SE2S		



Renner

RDKS

		AU	11/12-	Golf VII	
	Schrägheck		165305	8667	VO 516035
	1,0 TSI (85 kW) / 1,2 TSI (63/77/81 kW) / 1,4 TSI (90/92/103/110 kW) / 1,6 TDI (66/77/81 kW) / 2,0 TDI (103/110/132 kW) / 1,4 TGI (81 kW) / e-Golf (85 kW)		205/55R16		6½ J x16 H2 5x112x57 ET 46
	Keine Schneeketten möglich!		Kugel sw 17 M14 x 1,5 x 27		€ 78,50
			ASC; ASS; CUC; Huf 2.4; Huf 3.4; Huf 3.5; SE1C1; SE1C2; SE2C1; SE2C2; SE1S; SE2S		

Renner

RDKS

		AU, AUV	Golf VII, Golf VII Variant, Golf VII Sportsvan			
			lichtsilber-lackiert		Celsio	CS 656 50 5 12
			lichtsilber-lackiert / mattschwarz-lackiert		Tezzo	TZ 656 50 5 12
		Rad auch für Golf GTD + GTI (GTI nur 162KW)	ABE	205/55R16 ❄	6½ J x16 H2	
					5 x 112 ET 50	
CS	TZ	MK 306	Celsio: ASC; ASS; CUC; Huf 2.4; Huf 3.4; Huf 3.5; SE1C1; SE1C2; SE1S; TTC; TTS Tezzo: ASC; ASS; CUC; Huf 2.4; Huf 3.4; Huf 3.5; SE1C1; SE1C2; SE1S; TTC			

KRONPRINZ
MAGMA

RDKS

Golf VII, Golf VII Variant, Golf VII Sportsvan				AU, AUV	
MAGNA	Interio		IN 706 45 5 12	lichtsilber-lackiert / mattschwarz-lackiert	
	7 J x16 EH2+	205/55R16	ABE	Rad auch für Golf GTD + GTI (GTI nur 162KW)	
	5 x 112				
	ET 45				
RDKS	ASC; CUC; Huf 2.4; Huf 3.4; Huf 3.5; SE1C1; SE1S		MK 306	IN	IN



Golf VII, Golf VII Variant, Golf VII Sportsvan				AU, AUV	
MAGNA	Tezzo		TZ 757 50 5 12	lichtsilber-lackiert / mattschwarz-lackiert	
	7½ J x17 H2	205/50R17	ABE	Rad auch für Golf GTD + GTI bis 169KW / Golf R bis 221KW	
	5 x 112	215/45R17	ABE		
	ET 50	225/45R17	ABE		
RDKS	ASC; ASS; CUC; Huf 2.4; Huf 3.4; Huf 3.5; SE1C1; SE1C2; SE1S		MK 306	TZ	TZ



Golf VII GTI / GTD		05/13-	AU	
Renner	VO 516034	8247	165601	Schrägheck
	6 J x16 H2	205/55R16 M+S		2,0 GTI (162 kW) / 2,0 GTD (135 kW)
	5x112x57	205/55R16		
	ET 48			
€ 78,20	Kugel sw 17 M14 x 1,5 x 27		Nicht GTI Performance 169 kW.	
RDKS	ASS; CUC; Huf 2.4; Huf 3.4; Huf 3.5; SE1C1; SE1C2; SE2C1; SE2C2; SE1S; SE2S			









Golf VII GTI / GTD		05/13-	AU	
Renner	VO 516035	8667	165305	Schrägheck
	6½ J x16 H2	205/55R16		2,0 GTI (162 kW) / 2,0 GTD (135 kW)
	5x112x57			
	ET 46			
€ 78,50	Kugel sw 17 M14 x 1,5 x 27		Keine Schneeketten möglich! Nicht GTI Performance 169 kW.	
RDKS	ASC; ASS; CUC; Huf 2.4; Huf 3.4; Huf 3.5; SE1C1; SE1C2; SE2C1; SE2C2; SE1S; SE2S			





Golf VII Sportsvan		04/14-	AUV	
Renner	VO 515031	7755	155801	Mini-Van
	6 J x15 H2	195/65R15		1,0 TSI (85 kW) / 1,2 TSI (63/81 kW) / 1,4 TSI (92/110 kW) / 1,6 TDI (81 kW) / 2,0 TDI (110 kW)
	5x112x57			
	ET 43			
€ 67,10	Kugel sw 17 M14 x 1,5 x 27			
RDKS	ASC; ASS; CUC; Huf 3.5; SE1C1; SE1C2; SE2C1; SE1S; SE2S			





		AUV	04/14-	Golf VII Sportsvan	
	Mini-Van	165601	8247	VO 516034	Renner
	1,0 TSI (85 kW)/ 1,2 TSI (63/81 kW)/ 1,4 TSI (92/110 kW)/ 1,6 TDI (81 kW)/ 2,0 TDI (110 kW)	205/55R16		6 J x16 H2 5x112x57 ET 48	
		Kugel sw 17 M14 x 1,5 x 27		€ 78,20	RDKS
		ASC; CUC; Huf 2.4; Huf 3.4; Huf 3.5; SE1C1; SE1C2; SE2C1; SE2C2; SE1S; SE2S			
		AUV	04/14-	Golf VII Sportsvan	
	Mini-Van	165305	8667	VO 516035	Renner
	1,0 TSI (85 kW)/ 1,2 TSI (63/81 kW)/ 1,4 TSI (92/110 kW)/ 1,6 TDI (81 kW)/ 2,0 TDI (110 kW)	205/55R16		6½ J x16 H2 5x112x57 ET 46	
		Kugel sw 17 M14 x 1,5 x 27		€ 78,50	RDKS
		ASC; ASS; CUC; Huf 2.4; Huf 3.4; Huf 3.5; SE1C1; SE1C2; SE2C1; SE2C2; SE1S; SE2S			
		AUV	08/13-	Golf VII Variant	
	Variant	155801	7755	VO 515031	Renner
	1,0 TSI (85 kW)/ 1,2 TSI (63/77/81 kW)/ 1,4 TSI (90/92/110 kW)/ 1,6 TDI (77/81 kW)/ 2,0 TDI (110 kW)/ 1,4 TGI (81 kW)	195/65R15		6 J x15 H2 5x112x57 ET 43	
	Einige Ausführungen nur 16 Zoll! Nicht in Verbindung mit DCC (adaptive Fahrwerksregelung).	Kugel sw 17 M14 x 1,5 x 27		€ 67,10	RDKS
		ASC; ASS; CUC; Huf 3.5; SE1C1; SE1C2; SE2C1; SE1S; SE2S			
		AUV	08/13-	Golf VII Variant	
	Variant	165601	8247	VO 516034	Renner
	1,0 TSI (85 kW)/ 1,2 TSI (63/77/81 kW)/ 1,4 TSI (90/92/110 kW)/ 1,6 TDI (77/81 kW)/ 2,0 TDI (110 kW)/ 1,4 TGI (81 kW)	205/55R16 M+S 205/55R16		6 J x16 H2 5x112x57 ET 48	
		Kugel sw 17 M14 x 1,5 x 27		€ 78,20	RDKS
		ASC; CUC; Huf 2.4; Huf 3.4; Huf 3.5; SE1C1; SE1C2; SE2C1; SE2C2; SE1S; SE2S			
		AUV	08/13-	Golf VII Variant	
	Variant	165305	8667	VO 516035	Renner
	1,0 TSI (85 kW)/ 1,2 TSI (63/77/81 kW)/ 1,4 TSI (90/92/110 kW)/ 1,6 TDI (77/81 kW)/ 2,0 TDI (110 kW)/ 1,4 TGI (81 kW)	205/55R16		6½ J x16 H2 5x112x57 ET 46	
	Keine Schneeketten möglich!	Kugel sw 17 M14 x 1,5 x 27		€ 78,50	RDKS
		ASC; ASS; CUC; Huf 2.4; Huf 3.4; Huf 3.5; SE1C1; SE1C2; SE2C1; SE2C2; SE1S; SE2S			

Jetta		08/05-12/10	1KM	
Renner	VO 515024	9165	154104	Stufenheck
	6 J x15 H2	195/65R15		1,4 TSI (103 kW)/ 1,6i (75/85 kW)/ 2,0 FSI (110 kW)/
	5x112x57	205/60R15		1,9 TDI (77 kW)/ 2,0 TDI (103 kW)
	ET 47			
	€ 63,90	Kugel sw 17 M14 x 1,5 x 27		
RDKS				



Jetta		08/05-12/10	1KM	
Renner	AD 516012	9535	164001	Stufenheck
	6 J x16 H2	205/55R16 M+S		1,4 TSI (103 kW)/ 1,6i (75/85 kW)/ 2,0 FSI (110 kW)/
	5x112x57			2,0 TFSI (147 kW)/ 1,9 TDI (77 kW)/
	ET 50			2,0 TDI (103/125 kW)
	€ 74,50	Kugel sw 17 M14 x 1,5 x 27		
RDKS				

Jetta		08/05-12/10	1KM	
Renner	VO 516015	9915	163902	Stufenheck
	6½ J x16 H2	205/55R16		1,4 TSI (103 kW)/ 1,6i (75/85 kW)/ 2,0 FSI (110 kW)/
	5x112x57			1,9 TDI (77 kW)/ 2,0 TDI (103/125 kW)
	ET 50			
	€ 75,00	Kugel sw 17 M14 x 1,5 x 27		
RDKS				

Jetta		01/11-	16	
Renner	VO 515024	9165	154104	Stufenheck
	6 J x15 H2	195/65R15		1,2 TSI (77 kW)/ 1,4 TSI (90/92/110 kW)/
	5x112x57	205/60R15		1,6 TDI (77 kW)/ 2,0 TDI (81/103/110 kW)/ Hybrid (110 kW)/
	ET 47			4-motion
	€ 63,90	Kugel sw 17 M14 x 1,5 x 27		
RDKS		CUC ; SE1C1 ; SE2C1 ; SE1S ; SE2S		

Jetta		01/11-	16	
Renner	AD 516012	9535	164001	Stufenheck
	6 J x16 H2	205/55R16		1,2 TSI (77 kW)/ 1,4 TSI (90/92/110/118 kW)/ 2,0 TSI (147/155 kW)/
	5x112x57			1,6 TDI (77 kW)/ 2,0 TDI (81/103/110 kW)/ Hybrid (110 kW)/
	ET 50			4-motion
	€ 74,50	Kugel sw 17 M14 x 1,5 x 27		
RDKS				

		16	01/11-	Jetta	
	Stufenheck	163902	9915	VO 516015	Renner
	1,2 TSI (77 kW) / 1,4 TSI (90/92/110/118 kW) / 2,0 TSI (147/155 kW) / 1,6 TDI (77 kW) / 2,0 TDI (81/103/110 kW) / Hybrid (110 kW) / 4-motion	205/55R16		6½ J x16 H2 5x112x57 ET 50	
		Kugel sw 17 M14 x 1,5 x 27		€ 75,00	RDKS
		ASC; ASS; CUC; Huf 2.4; Huf 3.4; Huf 3.5; SE1C1; SE1C2; SE2C1; SE2C2; SE1S; SE2S			

		16	Jetta				
	CS		TZ	lichtsilber-lackiert	Celsio	CS 656 50 5 12	MAGNA
				lichtsilber-lackiert / mattschwarz-lackiert	Tezzo	TZ 656 50 5 12	
				ABE	205/55R16 ❄	6½ J x16 H2 5 x 112 ET 50	
				MK 306		Celsio: ASC; ASS; CUC; Huf 2.4; Huf 3.4; Huf 3.5; SE1C1; SE1C2; SE1S; TTC; TTS Tezzo: ASC; ASS; CUC; Huf 2.4; Huf 3.4; Huf 3.5; SE1C1; SE1C2; SE1S; TTC	
				€ 75,00	RDKS		

		2DM	01/00-05/06	LT	
	Transporter	154512	8360	ME 615014	Stahl
	46	195/70R15		5½ J x15 H2 6x205x161 ET 108	
Für Zwillingsbereifung. Auch Vorderachse.				€ 112,00	RDKS

		2DM	01/00-05/06	LT	
	Transporter	154517	8555	ME 615016	Stahl
	28/35	195/70R15		6 J x15 H2 5x130x84 ET 75	
		225/70R15		€ 84,50	
		Kugel sw 19 M14 x 1,5 x 34		€ 84,50	RDKS

		6X	10/98-03/05	Lupo	
	Steilheck	132903	4645	VO 513015	Stahl
	1,0i/1,4i/1,7SDI	175/65R13		5½ J x13 H2 4x100x57 ET 43	
		Kugel sw 17 M12 x 1,5 x 23,5		€ 50,20	
				€ 50,20	RDKS

Passat		11/00-02/05	3BG	
Stahl	*AD 515010	8955	152505	Stufenheck, Variant
	6 J x15 H2	195/65R15		1,6i/1,8i/1,8T/2,0i/1,9TDI (74/96 kW)
	5x112x57 ET 37			
€ 65,50		Kugel sw 17 M14 x 1,5 x 27		Wenn 6Jx15 ET 45 eingetragen, ist auch AD 515008 einsetzbar. AD 515008 nur M+S.
RDKS				



Passat		11/00-02/05	3BG	
Stahl	*AD 516004	9490	162201	Stufenheck, Variant
	6 J x16 H2	205/55R16 M+S		1,6i/2,0i/2,0i 5V/1,8i V5 Turbo/V5/1,9TDI/ V6/V6 TDI/4Motion
	5x112x57 ET 40			
€ 81,40		Kugel sw 17 M14 x 1,5 x 27		Die Radkappen vom 7 x 16 Rad können nicht verbaut werden.
RDKS				





Passat		03/05-09/10	3C	
Renner	VO 516025	8425	163904	Stufenheck, Variant
	6½ J x16 H2	205/55R16		1,6 TDI (77 kW)/2,0 Blue TDI (105 kW)/1,4 TSI EcoFuel (110 kW)
	5x112x57	205/55R16		1,4 TSI/1,6i (75 kW)/1,6 FSI (85 kW)/1,8 TSI/2,0 FSI (110 kW)/ 2,0 TFSI/TSI/1,9 TDI/2,0 TDI (81/103/125 kW)/4-Motion
	ET 42	215/55R16		
€ 80,30		Kugel sw 17 M14 x 1,5 x 27		FZG-Papiere beachten: Je nach Ausführung unterschiedliche Reifenabmessungen zulässig. Nicht zulässig für 3,2 V6 FSI (184 kW)! Bis EGBE Nachtrag *36.
RDKS				



Passat		10/10-10/14	3C	
Renner	VO 516030		165301	Stufenheck, Variant
	6½ J x16 H2	205/55R16		1,4 TSI (90 kW)/1,4 TSI (118 kW)/1,8 TSI (118)/2,0 TSI (155 kW)/ 1,6 TDI (77 kW)/2,0 TDI (103/125/130 kW)/1,4 EcoFuel (110 kW)
	5x112x57	215/55R16		
	ET 42			
€ 80,30		Kugel sw 17 M14 x 1,5 x 27		Serienrad mit Flow-Form-Felge. Bis EGBE Nachtrag *36.
RDKS				



Passat / Passat Variant			3C, 3c			
RENNER MAGNA	Celsio	CS 706 45 5 12	lichtsilber-lackiert			
	Interio	IN 706 45 5 12	lichtsilber-lackiert / mattschwarz-lackiert			
	7 J x16 EH2+	205/55R16 *	ABE			Serienbereifung beachten!
	5 x 112	215/55R16 *	ABE			
ET 45						
RDKS			Celsio: ASC; CUC; Huf 3.4; Huf 3.5; SE1C1; SE1S / OE: Huf 100056 Interio: ASC; CUC; Huf 2.4; Huf 3.4; Huf 3.5; SE1C1; SE1S / OE: Huf 100056	MK 306		

		3C, 3c	Passat / Passat Variant	
	TZ	lichtsilber-lackiert / mattschwarz-lackiert	Tezzo	TZ 756 42 5 12
			ABE 205/55R16 * TÜV 215/55R16	7½ J x16 H2 5 x 112 ET 42
		MK 306	ASC; ASS; CUC; Huf 2.4; Huf 3.4; Huf 3.5; SE1C1; SE1C2; SE15; TTC / OE: Huf 100056	

KRONPRINZ
MAGMA

RDKS

		3C, 3c	Passat / Passat Variant	
	CS	lichtsilber-lackiert	Celsio	CS 707 45 5 12
			ABE 205/50R17 * ABE 215/45R17 * ABE 225/45R17 *	7 J x17 EH2+ 5 x 112 ET 45
		MK 306	ASC; ASS; CUC; Huf 2.4; Huf 3.4; Huf 3.5; SE1C1; SE1C2; SE15; TTC / OE: Huf 100056	

KRONPRINZ
MAGMA

RDKS

		3C, 3c	Passat Alltrack	
	CS	lichtsilber-lackiert	Celsio	CS 807 35 5 12
			ABE 205/50R17 * ABE 215/50R17 ABE 225/45R17 *	8 J x17 H2 5 x 112 ET 35
		MK 306	ASC; ASS; CUC; Huf 2.4; Huf 3.4; Huf 3.5; SE1C1; SE15 / OE: Huf 100056	

KRONPRINZ
MAGMA

RDKS

		3C	11/14-	Passat	
	Stufenheck, Variant	1,4 TSI (92/110 kW) / 1,8 TSI (132 kW) / 1,6 TDI (88 kW) / 2,0 TDI (110/140 kW)	165306	8426	VO 516037
			215/60R16		6½ J x16 H2 5x112x57 ET 41
			Ab EGBE Nachtrag *37. Nicht 2,0 TSI (162/206 kW) / 2,0 TDI (176 kW).		€ 80,30
			ASC; ASS; CUC; Huf 2.4; Huf 3.4; Huf 3.5; SE1C1; SE1C2; SE2C1; SE2C2; SE15; SE25 / OE: Huf 100056		

Remner



RDKS



		3C	Passat / Passat Variant (Neues Modell)	
	IN	lichtsilber-lackiert / mattschwarz-lackiert	Interio	IN 706 38 5 12
			Freigabe in Vorbereitung!	7 J x16 EH2+ 5 x 112 ET 38
		MK 306	ASC; CUC; Huf 2.4; Huf 3.4; Huf 3.5; SE1C1; SE15 / OE: Huf 100056	

KRONPRINZ
MAGMA

RDKS

Passat Alltrack (Neues Modell)			
MAGNA	in Vorbereitung		Radabbildung in Vorbereitung
RDKS			



Passat CC / CC			3CC	
MAGNA	Tezzo	TZ 757 35 5 12	lichtsilber-lackiert / mattschwarz-lackiert	
	7½ J x17 H2	205/50R17	ABE	
	5 x 112	225/45R17	ABE	
	ET 35			
RDKS ASC; ASS; CUC; Huf 2.4; Huf 3.4; Huf 3.5; SE1C1; SE1C2; SE15 / OE: Huf 100054			MK 306	
				
			TZ	TZ

Phaeton			3D, 3d	
MAGNA	Celsio	CS 807 35 5 12	lichtsilber-lackiert	
	Interio	IN 807 35 5 12	lichtsilber-lackiert / mattschwarz-lackiert	
	8 J x17 EH2+	235/55R17	ABE	
	5 x 112			
	ET 35			
RDKS Celsio: ASC; ASS; CUC; Huf 2.4; Huf 3.4; Huf 3.5; SE1C1; SE15 / OE: Huf 100108 Interio: ASC; CUC; Huf 3.5; SE1C1; SE15			MK 306	
				
			CS	IN

Polo		10/99-10/01	6N, 6NF
Stahl	VO 513015	4645	132903
	5½ J x13 H2	175/65R13	Steilheck
	4x100x57		1,0i/ 1,4i/ 1,6i/ 1,7 SDI/ 1,9 D
	ET 43		
€ 50,20		Kugel sw 17 M12 x 1,5 x 23,5	
RDKS			



Polo		11/01-05/09	9N
Renner	VO 514015	5210	143502
	5 J x14 H2	165/70R14	Schrägheck
	5x100x57		1,2i/1,2i 12V/1,4i 16-V (55kW)/1,4TDi/1,9 SDI
	ET 35		
€ 56,00		Kugel sw 17 M14 x 1,5 x 27	FZG-Schein beachten, unterschiedliche Rad-/Reifenkombinationen möglich. Die Radkappen vom 6 x 14 Rad können nicht verbaut werden! Radkappe mit der OE-Nummer: 6Q0 601 147 M verwenden.
RDKS			

		9N	11/01-05/09	Polo	
	Schrägheck		143402	7280	VO 514016
	1,2i/1,2i 12V/1,4i 16-V (55/74kW) /1,4 TDi/ 1,9 SDI/1,9 TDi		185/60R14		6 J x14 H2 5x100x57 ET 43
	FZG-Schein beachten, unterschiedliche Rad-/Reifenkombinationen möglich. Die Radkappen vom 5 x 14 Rad können nicht verbaut werden! Radkappe mit der OE-Nummer: 6Q0 601 147 L verwenden.		Kugel sw 17 M14 x 1,5 x 27		€ 58,10
					RDKS

		9N	Polo		
		lichtsilber-lackiert / mattschwarz-lackiert	Seismo		SO 604 38 5 00
		lichtsilber-lackiert / mattschwarz-lackiert	Interio		IN 604 38 5 00
SO	IN		ABE	165/70R14 *	6 J x14 H2
			ABE	175/65R14 *	5 x 100
			ABE	185/60R14 *	ET 38
		MK 303	Seismo: ASC ; ASS ; Huf 2.4 ; Huf 3.4 ; SE1C1 ; SE1C2 ; SE1S ; TTC ; TTS Interio: ASC ; ASS ; Huf 2.4 ; Huf 3.4 ; SE1C1 ; SE1C2 ; SE1S ; TTC ; TTS		
					RDKS



		9N	11/01-05/09	Polo	
	Schrägheck		152506	9545	VO 515020
	1,2i/1,2i 12V/1,4i 16-V (55/74kW) /1,4 TDi/ 1,9 SDI/1,9 TDi		185/55R15 M+S 195/50R15 195/55R15		6 J x15 H2 5x100x57 ET 43
	FZG-Schein beachten, unterschiedliche Rad-/Reifenkombinationen möglich. OE-Radkappe: 6Q0 601 147 N.		Kugel sw 17 M14 x 1,5 x 27		€ 64,50
					RDKS

		9N	05/06-05/09	Polo GTI	
	Schrägheck		152506	9545	VO 515020
	1,8 T (110 kW)		185/55R15 M+S 195/50R15 195/55R15		6 J x15 H2 5x100x57 ET 43
	OE-Radkappe: 6Q0 601 147 N. Je nach Ausführung unterschiedliche Reifenabmessung vorgeschrieben.		Kugel sw 17 M14 x 1,5 x 27		€ 64,50
					RDKS

		9N	Polo		
		lichtsilber-lackiert	Celsio		CS 655 35 5 00
		lichtsilber-lackiert / mattschwarz-lackiert	Tezzo		TZ 655 35 5 00
CS	TZ	Rad auch für Polo GTI 110 kW Bereifung 185/55R15 M+S ABE + 195/55R15 ABE	ABE	185/55R15 M+S *	6½ J x15 H2
			ABE	195/50R15 *	5 x 100
			ABE	195/55R15 *	ET 35
		MK 303	Celsio: ASC ; ASS ; CUC ; Huf 2.4 ; Huf 3.4 ; SE1C1 ; SE1C2 ; SE1S ; TTC ; TTS Tezzo: ASC ; ASS ; CUC ; Huf 2.4 ; Huf 3.4 ; SE1C1 ; SE1C2 ; SE1S ; TTC		
					RDKS



Polo Fun			01/04-04/05	9N	
Stahl	VO 515011	8380	152503	SUV	
	6 J x15 H2	185/60R15		1,2i (40 kW) / 1,2i-16V (47 kW) / 1,4i-16V (55 kW) /	
	5x100x57			1,4 FSI (63 kW) / 1,4i-16V (74 kW) / 1,4 TDI (55 kW) /	
	ET 38			1,9 TDI (74 kW)	
	€ 64,50	Kugel sw 17 M14 x 1,5 x 27			
RDKS					

Cross Polo			02/06-05/09	9N	
Stahl	VO 515011	8380	152503	SUV	
	6 J x15 H2	185/60R15 M+S		1,2i-16V (47 kW) / 1,4i-16V (55/59/77 kW) /	
	5x100x57			1,4 TDI (51 kW) / 1,9 TDI (74 kW)	
	ET 38				
	€ 64,50	Kugel sw 17 M14 x 1,5 x 27			
RDKS					

Polo Fun / Cross Polo				9N		
MAGNA	Celsio	CS 655 35 5 00		lichtsilber-lackiert		
	Tezzo	TZ 655 35 5 00		lichtsilber-lackiert / mattschwarz-lackiert		
	6½ J x15 H2	185/60R15 M+S	☼	ABE		
	5 x 100					
	ET 35					
RDKS Celsio: ASC; ASS; CLUC; Huf 2.4; Huf 3.4; Huf 3.5; SE1C1; SE1C2; SE1S; TTC; TTS Tezzo: ASC; ASS; CLUC; Huf 2.4; Huf 3.4; Huf 3.5; SE1C1; SE1C2; SE1S; TTC				MK 303	CS	TZ

Polo			06/09-	6R	
Renner	VO 514015	5210	143502	Schrägheck	
	5 J x14 H2	175/70R14		1,0i (44/55 kW) / 1,2i (44/51 kW) / 1,2 TSI (66/77 kW) / 1,4i (63 kW) /	
	5x100x57			1,2 TDI (55 kW) / 1,4 TDI (55/66 kW) / 1,6 TDI (55/66 kW) /	
	ET 35			Bifuel (63/60 kW)	
	€ 56,00	Kugel sw 17 M14 x 1,5 x 27		Nicht zulässig für BlueMotion Technologie (BMT)	
RDKS SE1S					

Polo				6R	
MAGNA	Celsio	CS 554 38 5 00		lichtsilber-lackiert	
	5½ J x14 H2	175/65R14	☼	ABE	
	5 x 100	175/70R14		ABE	
	ET 38				
RDKS ASC; ASS; Huf 2.4; Huf 3.4; SE1C1; SE1C2; SE1S; TTC; TTS				MK 303	CS

6R		Polo					
		lichtsilber-lackiert / mattschwarz-lackiert		Interio	IN 604 38 5 00	KRONPRINZ MAGMA	
		ABE	175/65R14	6 J x14 H2			
		ABE	175/70R14				5 x 100
		ABE	185/60R14				ET 38
IN	IN	MK 303	ASC; ASS; Huf 2.4; Huf 3.4; SE1C1; SE1C2; SE1S; TTC; TTS			RDKS	



6R		06/09-	Polo			
	Schrägheck 1,0i (44/55 kW)/ 1,0 TSI (70/81 kW)/ 1,2i (44/51 kW)/ 1,2 TSI (66/77/81 kW)/ 1,4i (63 kW)/ 1,2 TDI (55 kW)/ 1,4 TDI (55/66/77 kW)/ 1,6 TDI (55/66/77 kW)/ Bifuel (63/60 kW)	154105	7760	VO 515030		Renner
		185/60R15		6 J x15 H2		
				5x100x57		
		Kugel sw 17 M14 x 1,5 x 27		€ 64,50		
		CUC; SE1C1; SE1C2; SE2C1; SE1S; SE2S				RDKS



6R		06/10-10/12	Polo GTI			
	Schrägheck 1,4 TSI (132 kW)	154105	7760	VO 515030		Renner
		185/60R15 M+S		6 J x15 H2		
				5x100x57		
		Kugel sw 17 M14 x 1,5 x 27		€ 64,50		
						RDKS

6R		11/12-	Polo GTI / R			
	Schrägheck 1,4 TSI (132 kW)/ 2,0 TSI (162 kW)	162602		VO 516036		Stahl
		195/50R16 M+S		6 J x16 H2		
				5x100x57		
		Kugel sw 17 M14 x 1,5 x 27		€ 74,50		
		ASC; CUC; Huf 2.4; Huf 3.4; SE1C1; SE2C1; SE2C2; SE1S; SE2S				RDKS



6R		06/10-	Cross Polo			
	SUV 1,2i (51 kW)/ 1,2 TSI (66/77 kW)/ 1,4i (63 kW)/ 1,2 TDI (55 kW)/ 1,4 TDI (66 kW)/ 1,6 TDI (66 kW)	143502	5210	VO 514015		Renner
		175/70R14		5 J x14 H2		
				5x100x57		
		Kugel sw 17 M14 x 1,5 x 27		€ 56,00		
		SE1S				RDKS



Cross Polo		06/10-	6R	
Renner	VO 515030	7760	154105	SUV
	6 J x15 H2	185/60R15		1,0 TSI (81 kW) / 1,2i (51 kW) / 1,2 TSI (66/77/81 kW) / 1,4i (63 kW) / 1,2 TDI (55 kW) / 1,4 TDI (66/77 kW) / 1,6 TDI (66/77 kW)
	5x100x57			
	ET 38			
	€ 64,50	Kugel sw 17 M14 x 1,5 x 27		
RDKS	CUC; SE1C1; SE1C2; SE2C1; SE1S; SE2S			

Polo / Polo GTI / Cross Polo				6R		
MAGNA	Interio	IN 605 35 5 00	lichtsilber-lackiert / mattschwarz-lackiert			
	6 J x15 H2	185/55R15	ABE	GTI nur M+S		
	5 x 100	185/60R15	ABE			
	ET 35	195/55R15	ABE			
RDKS	ASC; ASS; CUS; Huf 2.4; Huf 3.4; SE1C1; SE1C2; SE1S; TTC; TTS			MK 303	IN	IN

Polo / Polo GTI / Cross Polo				6R		
MAGNA	Celsio	CS 655 35 5 00	lichtsilber-lackiert			
	Tezzo	TZ 655 35 5 00	lichtsilber-lackiert / mattschwarz-lackiert			
	6½ J x15 H2	185/55R15	ABE	GTI nur M+S		
	5 x 100	185/60R15	ABE			
	ET 35					
RDKS	Celsio: ASC; ASS; CUC; Huf 2.4; Huf 3.4; Huf 3.5; SE1C1; SE1C2; SE1S; TTC; TTS Tezzo: ASC; ASS; CUC; Huf 2.4; Huf 3.4; Huf 3.5; SE1C1; SE1C2; SE1S; TTC			MK 303	CS	TZ

Scirocco		08/08-	13	
Renner	VO 516025	8425	163904	Coupé
	6½ J x16 H2	205/55R16 M+S		1,4 TSI (90/118 kW) / 2,0 TSI (147/155 kW) / 2,0 TDI (103/125 kW)
	5x112x57			
	ET 42			
	€ 80,30	Kugel sw 17 M14 x 1,5 x 27		
RDKS	ASC; ASS; CUC; Huf 2.4; Huf 3.4; Huf 3.5; SE1C1; SE1C2; SE2C1; SE2C2; SE1S; SE2S			

Scirocco				13		
MAGNA	Interio	IN 706 38 5 12	lichtsilber-lackiert / mattschwarz-lackiert			
	7 J x16 EH2+	205/55R16M+S	ABE			
	5 x 112					
	ET 38					
RDKS	ASC; CUC; Huf 2.4; Huf 3.4; Huf 3.5; SE1C1; SE1S			MK 306	IN	IN

		13	Scirocco		
		lichtsilber-lackiert	Celsio	CS 807 35 5 12	
		lichtsilber-lackiert / mattschwarz-lackiert	Interio	IN 807 35 5 12	
			ABE	205/50R17 ☼	8 J x17 EH2+ 5 x 112 ET 35
			ABE	215/45R17 ☼	
	ABE	225/45R17			
CS	IN	MK 306	Celsio: ASC; ASS; CUC; Huf 2.4; Huf 3.4; Huf 3.5; SE1C1; SE1S Interio: ASC; CUC; Huf 3.5; SE1C1; SE1S		



KRONPRINZ
MAGMA

RDKS

		7M	05/01-07/10	Sharan I	
	Van		163801		VO 516010
	1,8T (110 kW)/2,0i (110 kW)/2,8 V6 (150 kW)/		195/60R16		6 J x16 H2
	1,9TDI PD (66/85/96/110 kW)		205/55R16		5x112x57
	(205/55R16 nicht für 2,8 V6 150 kW)		215/55R16		ET 53
	VO 516010 nicht für VW T4 zulässig! Nur für Fahrzeuge mit 16 Zoll Bremsanlage. Einige Ausführungen nur M+S bzw. Reinforced Reifen. Je nach Ausf. unterschiedliche Reifenabmessungen zulässig.		Kugel sw 19 M14 x 1,5 x 34		€ 79,70

Stahl

RDKS

		7M	Sharan		
		lichtsilber-lackiert	Celsio	CS 656 50 5 12	
		lichtsilber-lackiert / mattschwarz-lackiert	Tezzo	TZ 656 50 5 12	
			ABE	195/60R16C ☼	6½ J x16 H2 5 x 112 ET 50
			ABE	205/55R16C ☼	
CS	TZ	MK 310	Celsio: ASC; ASS; CUC; Huf 2.4; Huf 3.4; Huf 3.5; SE1C1; SE1C2; SE1S; TTC; TTS Tezzo: ASC; ASS; CUC; Huf 2.4; Huf 3.4; Huf 3.5; SE1C1; SE1C2; SE1S; TTC		



KRONPRINZ
MAGMA

RDKS

		7N	08/10-	Sharan II	
	Van		165303		VO 516031
	1,4 TSI (110/147 kW) / 2,0 TDI (85/103/130 kW)		205/60R16		6½ J x16 H2
			215/60R16		5x112x57
					ET 33
	Serienrad mit Flow-Form-Felge.		Kugel sw 17 M14 x 1,5 x 27		€ 84,50
			ASC; ASS; CUC; Huf 2.4; Huf 3.4; Huf 3.5; SE1C1; SE1C2; SE2C1; SE2C2; SE1S; SE2S		

Renner

RDKS

		7N	Sharan II		
		lichtsilber-lackiert	Celsio	CS 706 38 5 12	
		lichtsilber-lackiert / mattschwarz-lackiert	Interio	IN 706 38 5 12	
		Achtung / Bremsanlage beachten	ABE	205/60R16 ☼	7 J x16 EH2+ 5 x 112 ET 38
			ABE	215/60R16 ☼	
	ABE	225/55R16 ☼			
CS	IN	MK 306	Celsio: ASC; CUC; Huf 3.4; Huf 3.5; SE1C1; SE1S Interio: ASC; CUC; Huf 2.4; Huf 3.4; Huf 3.5; SE1C1; SE1S		

KRONPRINZ
MAGMA

RDKS



T5		05/03-	7HC, 7HCA, 7HM, 7HMA
Renner	VO 616016	9685	163305
	6½ J x16 H2	205/65R16	Business, California, Multivan, Shuttle 2,0i (85 kW)/ 2,0 TSI (110 kW)/ 1,9 TDI (77 kW)/ 2,0 TDI (62/75/103 kW)/ 2,5 TDI (96/128 kW)/ 4-Motion
	5x120x65	215/65R16	
	ET 51		
€ 86,10	Kugel sw 19 M14 x 1,5 x 36		Nur zulässig bis max. 1700 kg Achslast!
RDKS	CUC; SE1C1; SE2C1; SE2C2; SE1S; SE2S		



T5		05/03-	7HC, 7HCA, 7HK, 7HKX0, 7JO
Renner	VO 616016	9685	163305
	6½ J x16 H2	205/65R16	Caravelle, Shuttle, Transporter 2,0i (85 kW)/ 2,0 TSI (110 kW)/ 1,9 TDI (63/77 kW)/ 4-Motion
	5x120x65	215/65R16	
	ET 51		
€ 86,10	Kugel sw 19 M14 x 1,5 x 36		Nur zulässig bei Achslast max. 1700 kg. Nur zulässig, wenn Radgröße 6½ J x 16 ET 51 serienmäßig verwendet werden darf. Je nach Ausführung unterschiedliche Reifenabmessungen zulässig.
RDKS	CUC; SE1C1; SE2C1; SE2C2; SE1S; SE2S		



T5		7HC*, 7HCA, 7HK*, 7HM*, 7HMA, 7JO	
MAGNA	Tezzo	TZ 656 40 5 20	lichtsilber-lackiert / matschwarz-lackiert
	6½ J x16 H2	205/65R16 *	ABE
	5 x 120	215/65R16 *	ABE
	ET 40	225/60R16 *	ABE
RDKS	ASC; ASS; CUC; Huf 2.4; Huf 3.4; Huf 3.5; SE1C1; SE1C2; SE1S; TTC		Serie









T5		05/03-	7HC, 7HCA, 7HM, 7HMA
Stahl	VO 617001	9215	175301
	7 J x17 H2	215/60R17 M+S	Business, California, Multivan, Shuttle 2,0i (85 kW)/ 2,0 TSI (110/150 kW)/ 3,2i V6 (173 kW)/ 1,9 TDI (77 kW)/ 2,0 TDI (62/75/103/132 kW)/ 2,5 TDI (96/128 kW)/ 4-Motion
	5x120x65,1	235/55R17	
	ET 55		
€ 117,80	Kugel sw 19 M14 x 1,5 x 36		FZG-Schein beachten. Radgröße muss in den FZG-Papieren eingetragen sein.
RDKS			





T5		05/03-	7HC, 7HCA, 7HK, 7HKX0, 7JO
Stahl	VO 617001	9215	175301
	7 J x17 H2	215/60R17 M+S	Caravelle, Shuttle, Transporter 2,0i (85 kW)/ 2,0 TSI (110/150 kW)/ 3,2 V6 (173 kW)/ 1,9 TDI (63/77 kW)/ 2,0 TDI (62/75/103/132 kW)/ 2,5 TDI (128/96 kW)/ 4-Motion
	5x120x65,1	235/55R17	
	ET 55		
€ 117,80	Kugel sw 19 M14 x 1,5 x 36		FZG-Schein muss unbedingt beachtet werden. Je nach Ausführung nur 16 Zoll zulässig. Je nach Ausführung unterschiedliche Rad-/Reifenkombinationen zulässig.
RDKS			





		7HC*, 7HCA, 7HK*, 7HM*, 7HMA, 7JO			T5	
 <p>TZ</p>	 <p>TZ</p>	lichtsilber-lackiert / mattschwarz-lackiert		Tezzo	TZ 807 50 5 20	
		Achslasten beachten / Bei 235/55R17 Serienbereifung beachten	ABE	225/55R17 * ⁸	8 J x17 H2	5 x 120 ET 50
			ABE	235/55R17		
Serie		ASC; ASS; CUC; Huf 2.4; Huf 3.4; Huf 3.5; SE1C1; SE1C2; SE1S; TTC			RDKS	
		7HC, 7HMA, 7JO	03/11-	T5 BlueMotion		
	Caravelle, Shuttle, Transporter	163308		VO 616025	Stahl	
	2,0 TDI (84 kW)	215/65R16C		6½ J x16 H2 5x120x65 ET 51		
		Kugel sw 19 M14 x 1,5 x 36		€ 86,10		
		SE1S; SE2S			RDKS	
		7HC, 7HCA, 7HK, 7HKX0, 7JO	05/04-	T5 Maxi		
	Caravelle, Shuttle, Transporter	163306		VO 616017	Stahl	
	2,0 TSI (110 kW) / 1,9 TDI (77 kW) / 2,0 TDI (62/75/103 kW) / 2,5 TDI (96 kW) / 4-Motion	205/65R16 215/65R16		6½ J x16 H2 5x120x65 ET 52		
	Nur zulässig, wenn Radgröße 6½ x 16 ET 52 serienmäßig verwendet werden darf. FZG-Schein beachten: Je nach Ausführung unterschiedliche Reifenabmessungen zulässig.	Kugel sw 19 M14 x 1,5 x 36		€ 88,80		
					RDKS	
		7HC	12/10-	T5 Rockton		
	Multivan	163316		VO 616024	Stahl	
	2,0 TDI 4MOTION (103 kW)	225/75R16		6½ J x16 H2 5x120x65 ET 52		
		Kugel sw 19 M14 x 1,5 x 36		€ 88,80		
		CUC; SE1C1; SE2C1; SE2C2; SE1S; SE2S			RDKS	
		7HC, 7HMA	08/15-	T6		
	Multivan, Transporter	163305	9685	VO 616016	Renner	
	2,0 TDI (62/75/103/110 kW)	205/65R16C		6½ J x16 H2		
	2,0 TDI (62/75/103/110/132 kW)	215/65R16C		5x120x65 ET 51		
Nur zulässig bei Achslast max. 1700 kg. Nur zulässig, wenn Radgröße 6½ x 16 ET 51 serienmäßig verwendet werden darf. Je nach Ausführung unterschiedliche Reifenabmessungen zulässig.				€ 86,10		
		CUC; SE1C1; SE2C1; SE2C2; SE1S; SE2S			RDKS	

T6				
KRONPRINZ MAGNA	in Vorbereitung			Radabbildung in Vorbereitung
RDKS				

T6 Maxi		08/15-	7HC, 7HMA	
Stahl	VO 616017	163306	Multivan, Transporter	
	6½ J x16 H2	205/65R16C	2,0 TDI (62/75/103/110 kW)	
	5x120x65	215/65R16C	2,0 TDI (62/75/103/110/132 kW)	
	ET 52			
	€ 88,80		Nur zulässig, wenn Radgröße 6½ J x 16 ET 52 serienmäßig verwendet werden darf. FZG-Schein beachten: Je nach Ausführung unterschiedliche Reifenabmessungen zulässig.	
RDKS				



T6		08/15-	7HC, 7HMA		
Stahl	VO 617001	9215	175301	Multivan, Transporter	
	7 J x17 H2	215/60R17C		2,0 TSI (150 kW)/ 2,0 TDI (62/75/103/132/150 kW)	
	5x120x65,1	235/55R17C			
	ET 55	235/55R17 RF			
	€ 117,80			FZG-Schein beachten. Radgröße muss in den FZG-Papieren eingetragen sein. Je nach Ausführung unterschiedliche Reifenabmessungen zulässig.	
RDKS					



Tiguan		12/07-11/15	5N		
Renner	VO 516028	9922	163907	SUV	
	6½ J x16 H2	215/65R16		1,4 TSI (90/110/118 kW)/ 2,0 TSI (125/132/147/155 kW)/	
	5x112x57			2,0 TDI (81/103/110/125/130/135 kW)/ 4-Motion	
	ET 33				
	€ 84,50	Kugel sw 17 M14 x 1,5 x 27			
RDKS		ASC; ASS; CUC; Huf 2.4; Huf 3.4; Huf 3.5; SE1C1; SE1C2; SE2C1; SE2C2; SE1S; SE2S			

Tiguan I			5N		
KRONPRINZ MAGNA	Celsio	CS 706 38 5 12	lichtsilber-lackiert		
	Interio	IN 706 38 5 12	lichtsilber-lackiert / mattschwarz-lackiert		
	7 J x16 EH2+	215/65R16	ABE		
	5 x 112	225/60R16	ABE		
	ET 38	225/65R16	ABE		
RDKS		Celsio: ASC; CUC; Huf 3.4; Huf 3.5; SE1C1; SE1S / OE: Huf 100054 Interio: ASC; CUC; Huf 2.4; Huf 3.4; Huf 3.5; SE1C1; SE1S / OE: Huf 100054		MK 306	
				CS	IN



		12/15-	Tiguan II		
Radabbildung in Vorbereitung	SUV			INFO	Stahl
	INFO				
					RDKS

		Tiguan II (Neues Modell)			
Radabbildung in Vorbereitung					MAGMA
				in Vorbereitung	
					RDKS

		7L, 7P, 7p, 7PH, 7ph	Touareg I / Touareg II			
		lichtsilber-lackiert / mattschwarz-lackiert	Seismo	SO 807 48 5 30		MAGMA
		130 mm Lochkreis ab 155 kW	ABE	235/65R17 ❄	8 J x17 H2 5 x 130 ET 48	
SO	SO	Serie	ASC; ASS; CUC; Huf 2.4; Huf 3.4; SE1C1; SE1C2; SE1S; TTC / OE: Huf 100056			RDKS

		7L, 7P, 7p, 7PH, 7ph	Touareg I / Touareg II			
		lichtsilber-lackiert / mattschwarz-lackiert	Seismo	SO 808 55 5 30		MAGMA
		130 mm Lochkreis ab 155 kW	ABE	235/60R18 M+S ❄	8 J x18 H2 5 x 130 ET 55	
SO	SO	Serie	ASC; ASS; CUC; Huf 2.4; Huf 3.4; SE1C1; SE1C2; SE1S; TTC / OE: Huf 100056			RDKS

		1T	03/03-08/15	Touran / Cross Touran		
	Van	154104	9165	VO 515024		Renner
	1,2 TSI (77 kW) / 1,4 TSI (103 kW) / 1,6i (75 kW) / 1,6 FSI (85 kW) / 2,0 FSI (110 kW) / 1,9 TDI (74/66/77 kW) / 1,6 TDI (77 kW) / 2,0 TDI (103 kW) / 2,0 EcoFuel (80 kW) / 1,4 TSI/TGI EcoFuel (110 kW)	195/65R15		6 J x15 H2 5x112x57 ET 47		
	e1*2007/46*0357* bis Nachtrag *12 e1*2001/116*2011* bis Nachtrag 34	Kugel sw 17 M14 x 1,5 x 27		€ 63,90		
					CUC; SE1C1; SE2C1; SE1S; SE2S	RDKS

Touran I / Cross Touran				1T, 1t	
MAGNA	Interio		IN 605 45 5 12	lichtsilber-lackiert / mattschwarz-lackiert	
	6 J x15 H2	195/65R15 *	ABE		
	5 x 112	205/60R15 *	ABE		
	ET 45				
RDKS	ASC; ASS; CUS; Huf 2.4; Huf 3.4; SE1C1; SE1C2; SE1S; TTC; TTS		MK 306	IN	IN

Touran I / Cross Touran				1T, 1t	
MAGNA	Celsio		CS 655 47 5 12	lichtsilber-lackiert	
	6½ J x15 H2	195/65R15 *	ABE		CS
	5 x 112	205/60R15 *	ABE		
	ET 47				
RDKS	ASC; ASS; CUC; Huf 2.4; Huf 3.4; Huf 3.5; SE1C1; SE1C2; SE1S; TTC; TTS		MK 306		

Touran / Cross Touran			03/03-08/15	1T
Renner	AD 516012	9535	164001	Van
	6 J x16 H2	205/55R16 M+S		
	5x112x57			
	ET 50			
RDKS	€ 74,50	Kugel sw 17 M14 x 1,5 x 27		FZG-Schein beachten: Bei einigen Ausführungen des 1,9 TDI (77 kW) nicht zulässig. e1*2007/46*0357* bis Nachtrag *12 e1*2001/116*2011* bis Nachtrag 34

Touran			03/03-08/15	1T
Renner	VO 516015	9915	163902	Van
	6½ J x16 H2	205/55R16		
	5x112x57			
	ET 50			
RDKS	€ 75,00	Kugel sw 17 M14 x 1,5 x 27		Nicht zulässig für Cross Touran! e1*2007/46*0357* bis Nachtrag *12 e1*2001/116*2011* bis Nachtrag 34

Touran I / Cross Touran				1T, 1t	
MAGNA	Celsio		CS 656 50 5 12	lichtsilber-lackiert	
	Tezzo		TZ 656 50 5 12	lichtsilber-lackiert / mattschwarz-lackiert	
	6½ J x16 H2	205/55R16 *	ABE		
	5 x 112				
ET 50					
RDKS	Celsio: ASC; ASS; CUC; Huf 2.4; Huf 3.4; Huf 3.5; SE1C1; SE1C2; SE1S; TTC; TTS Tezzo: ASC; ASS; CUC; Huf 2.4; Huf 3.4; Huf 3.5; SE1C1; SE1C2; SE1S; TTC		MK 306	CS	TZ



		1T, 1t	Touran I / Cross Touran		
 CS		lichtsilber-lackiert	Celsio	CS 707 45 5 12	
	Bereifung Cross Touran 225/45R17 nur M+S!	ABE	225/45R17	7 J x17 EH2+ 5 x 112 ET 45	
	MK 306	ASC; ASS; CUC; Huf 2.4; Huf 3.4; Huf 3.5; SE1C1; SE1C2; SE1S; TTC			RDKS

		1T	09/15-	Touran II	
Radabbildung in Vorbereitung	Van	163399	7025	VO 516038	
	1,2 TSI (81 kW)/ 1,4 TSI (110 kW)/ 1,6 TDI (81 kW)/ 2,0 TDI (110 kW)	205/60R16		6½ J x16 H2 5x112x57 ET 48	
	e1*2007/46*0357* ab Nachtrag *14 e1*2001/116*2011* ab Nachtrag 36				€ 84,50

		1T	Touran II		
Radabbildung in Vorbereitung				in Vorbereitung	

		AA	06/11-	Up	
	Steilheck	143629	6795	VO 514021	
	1,0i (44/55 kW)/ 1,0 EcoFuel (50 kW)	165/70R14	175/65R14		5 J x14 H2 4x100x57 ET 35
	Baugleich Skoda Citigo und Seat Mii.	Kugel sw 17 M12 x 1,5 x 26		€ 56,80	
		ASC; CUC; Huf 2.4; Huf 3.4; Huf 3.5; SE1C1; SE2C1; SE2C2; SE1S; SE2S			RDKS

		AA	Up		
 CS		lichtsilber-lackiert	Celsio	CS 554 35 4 00	
		ABE	165/70R14	5½ J x14 H2	
		ABE	175/65R14	4 x 100	
		ABE	185/60R14	ET 35	
MK 205		ASC; ASS; Huf 2.4; Huf 3.4; SE1C1; SE1C2; SE1S; TTC; TTS			RDKS

C30		12/06-	M, M-2D	
Stahl	VV 515017	7995	154687	Schrägheck
	6 J x15 H2	195/65R15		1.6i (74 kW)/ 1.8i (92 kW)/ 2.0i (107 kW)/ 1.6 D (80 kW)/ 1,8 FlexiFuel (92 kW)
	5x108x63,3			
ET 46				
	€ 83,50	Kegel sw 19 M12 x 1,5/H15		
RDKS	ASC; ASS; CUC; CUS; Huf 2.4; Huf 3.4; Huf 3.5; SE1C1; SE1C2; SE2C2; SE1S; SE2S; TTC / OE: VDO S180052050Z			
C30		M, M-2D		
MAGNA	Celsio	CS 655 45 5 08	lichtsilber-lackiert	
	6½ J x15 H2	195/65R15	ABE	
	5 X 108	205/60R15	ABE	
ET 45				
RDKS	ASC; ASS; CUC; Huf 2.4; Huf 3.4; Huf 3.5; SE1C1; SE1C2; SE1S; TTC; TTS			MK 042 CS
C30		12/06-	M, M-2D	
Stahl	VV 516004	9225	163905	Schrägheck
	6½ J x16 H2	195/60R16	205/55R16	1.6i (74 kW)/ 1.8i (92 kW)/ 2.0i (107 kW)/ 2.4i (125 kW)/ T5 (162/169 kW)/ 1.6 D (80 kW)/ 2.0 D (100 kW)/ D5 (132 kW)/ 1,8 FlexiFuel (92 kW)
	5x108x63,3			
ET 52,5				
	€ 86,10	Kegel sw 19 M12 x 1,5/H15		
RDKS	ASC; ASS; CUC; Huf 2.4; Huf 3.4; Huf 3.5; SE1C1; SE1C2; SE2C1; SE2C2; SE1S; SE2S; TTC; TTS / OE: VDO S180052050Z			
C30		M, M-2D		
MAGNA	Interio	IN 706 45 5 08	lichtsilber-lackiert / mattschwarz-lackiert	
	7 J x16 EH2+	195/60R16	ABE	Bremsanlage beachten
	5 x 108		TÜV	
ET 45	205/55R16			
RDKS	ASC; CUC; Huf 2.4; Huf 3.4; Huf 3.5; SE1C1; SE1S			MK 042 IN IN
C70 Cabrio		M		
MAGNA	Tezzo	TZ 757 45 5 08	lichtsilber-lackiert / mattschwarz-lackiert	
	7½ J x17 H2	215/50R17	ABE	100 - 169 kW
	5 x 108		ABE	
ET 45	235/45R17	ABE		
RDKS	ASC; ASS; CUC; Huf 2.4; Huf 3.4; Huf 3.5; SE1C1; SE1C2; SE1S			MK 042 TZ TZ

		M	01/04-	S40 / V50	
	Stufenheck, Kombi		154687	7995	VV 515017
	1,6 (74 kW) / 1,8 (92 kW) / 1,6 D (81 kW)		195/65R15		6 J x15 H2 5x108x63,3 ET 46
	V50 ab 04/04-.		Kegel sw 19 M12 x 1,5/H15		€ 83,50
ASC; ASS; CUC; CUS; Huf 2.4; Huf 3.4; Huf 3.5; SE1C1; SE1C2; SE2C2; SE1S; SE2S; TTC / OE: VDO S180052050Z					

Stahl

RDKS

		M	S40 / V50		
			lichtsilber-lackiert	Celsio	CS 655 45 5 08
			ABE	195/65R15 ❄	6½ J x15 H2
			ABE	205/60R15 ❄	5 x 108
					ET 45
CS	MK 042		ASC; ASS; CUC; Huf 2.4; Huf 3.4; Huf 3.5; SE1C1; SE1C2; SE1S; TTC; TTS		



MAGMA

RDKS

		M	01/04-	S40 / V50	
	Stufenheck, Kombi		163905	9225	VV 516004
	1,6 (74 kW) 1,8 (92 kW) / 2,4 (103 kW) / 2,4i (125 kW) / T5 (162 kW) / 1,6 D (81 kW) / 2,0 D (100 kW) / D5 (132 kW)		195/60R16 205/55R16		6½ J x16 H2 5x108x63,3 ET 52,5
	V50 ab 04/04-.		Kegel sw 19 M12 x 1,5/H15		€ 86,10
ASC; ASS; CUC; Huf 2.4; Huf 3.4; Huf 3.5; SE1C1; SE1C2; SE2C1; SE2C2; SE1S; SE2S; TTC; TTS / OE: VDO S180052050Z					

Stahl

RDKS

		M	S40 / V50		
			lichtsilber-lackiert / mattschwarz-lackiert		Interio
					IN 706 45 5 08
			ABE	195/60R16	7 J x16 EH2+ 5 x 108
			ABE	205/55R16	
				ET 45	
IN	MK 042		ASC; CUC; Huf 2.4; Huf 3.4; Huf 3.5; SE1C1; SE1S		







MAGMA

RDKS

		F, FN2D	09/10-	S60 II / V60	
	Stufenheck, Kombi		163482	8275	VV 516005
	T3 (110 kW) / Drive (84 kW)		205/60R16		7 J x16 H2
	T3 (110 kW) / T4/T4F (132 kW) / 2,0T (149 kW) / T5 (177 kW) / Drive (84 kW) / D3 (120 kW) / D5 (151 kW) / T6 (224 kW) / AWD		215/55R16		5x108x63,3 ET 50
			Kegel sw 19 M14 x 1,5 x 33		€ 91,40
ASC; ASS; CUC; CUS; Huf 2.4; Huf 3.4; Huf 3.5; SE1C1; SE1C2; TTC / OE: VDO S180052050Z					



Stahl

RDKS

S60 II / V60				F, F-N2D		
MAGMA	Interio		IN 706 45 5 08		lichtsilber-lackiert / mattschwarz-lackiert	 
	7 J x16 EH2+	205/60R16	☼	ABE	Rad nicht frei für V60 Cross Country	
	5 x 108	215/55R16	☼	TÜV		
	ET 45					
RDKS	ASC; CUC; Huf 2.4; Huf 3.4; Huf 3.5; SE1C1; SE1S			MK 317	IN	
S80			05/06-	A		
Stahl	VV 516005	8275	163482	Stufenheck		
	7 J x16 H2	205/60R16		2,0i/ 2,0 F/ 2,5T/ 2,5TF/ 2,0 D/ 2,4D		
	5x108x63,3	225/55R16				
	ET 50	225/55R16		3,2i/ D5/ AWD		
RDKS	€ 91,40	Kegel sw 19 M14 x 1,5 x 33		Einige Ausführungen des 2,5T (147 kW) auch 215/55R16. Je nach Ausführung unterschiedliche Reifengrößen zulässig.		
S80				A, A-2D		
MAGMA	Interio		IN 706 45 5 08		lichtsilber-lackiert / mattschwarz-lackiert	 
	7 J x16 EH2+	205/60R16	☼	ABE		
	5 x 108	215/55R16	☼	ABE		
	ET 45	225/55R16		ABE		
RDKS	ASC; CUC; Huf 2.4; Huf 3.4; Huf 3.5; SE1C1; SE1S			MK 317	IN	
S90 / V90						
MAGMA	in Vorbereitung				Radabbildung in Vorbereitung	
RDKS						
V40			09/12-	M		
Stahl	VV 515017	7995	154687	Schrägheck		
	6 J x15 H2	195/65R15		D2 (84 kW)		
	5x108x63,3					
	ET 46					
RDKS	€ 83,50	Kegel sw 19 M12 x 1,5/H31				
ASC; ASS; CUC; CUS; Huf 2.4; Huf 3.4; Huf 3.5; SE1C1; SE1C2; SE2C2; SE1S; SE2S; TTC / OE: VDO S180052050Z						

		M	V40	
		lichtsilber-lackiert	Celsio	CS 655 45 5 08
	Rad nicht frei für V40 Cross Country	ABE	195/65R15 ❄	6½ J x15 H2 5 x 108 ET 45
		ABE	205/60R15 ❄	
	MK 042	ASC; ASS; CUC; Huf 2.4; Huf 3.4; Huf 3.5; SE1C1; SE1C2; SE1S; TTC; TTS		

		M	09/12-	V40	
	Schrägheck	163905	9225	VV 516004	
	T3 (110 kW)/ T4 (132 kW)/ D2 (84 kW)/ D3 (110 kW)/ D4 (130 kW)	205/55R16		6½ J x16 H2 5x108x63,3 ET 52,5	
		Kegel sw 19 M12 x 1,5/H31		€ 86,10	
		ASC; ASS; CUC; Huf 2.4; Huf 3.4; Huf 3.5; SE1C1; SE1C2; SE2C1; SE2C2; SE1S; SE2S; TTC; TTS/ OE: VDO S180052050Z			RDKS



		M	V40		
		lichtsilber-lackiert / mattschwarz-lackiert	Tezzo	TZ 656 45 5 08	
		Bremsanlage beachten / Rad nicht frei für V40 Cross Country	ABE	195/60R16 ❄	6½ J x16 H2 5 x 108 ET 45
			ABE	205/55R16 ❄	
			ABE	215/55R16	
MK 042	ASC; ASS; CUC; Huf 2.4; Huf 3.4; Huf 3.5; SE1C1; SE1C2; SE1S; TTC			RDKS	

		M	V40	
		lichtsilber-lackiert	Celsio	CS 707 47 5 08
	Rad nicht frei für V40 Cross Country	ABE	205/50R17	7 J x17 EH2+ 5 x 108 ET 47
		ABE	215/45R17 ❄	
		ABE	225/45R17	
MK 042	ASC; ASS; CUC; Huf 2.4; Huf 3.4; Huf 3.5; SE1C1; SE1C2; SE1S; TTC			RDKS

		M	12/12-	V40 Cross Country	
	SUV	163905	9225	VV 516004	
	D2 (84 kW)/ D3 (110 kW)/ D4 (130 kW)/ T4 (132 kW)	205/60R16		6½ J x16 H2 5x108x63,3 ET 52,5	
		Kegel sw 19 M12 x 1,5/H31		€ 86,10	
		ASC; ASS; CUC; Huf 2.4; Huf 3.4; Huf 3.5; SE1C1; SE1C2; SE2C1; SE2C2; SE1S; SE2S; TTC; TTS/ OE: VDO S180052050Z			RDKS

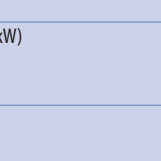
V70 II			08/07-	B, B-2D	
Stahl	VV 516005	8275	163482	Kombi	
	7 J x16 H2	205/60R16		2,0i/ 2,0F/ 2,0 D/ 2,4 D	
	5x108x63,3	225/55R16			
	ET 50	225/55R16		2,5T/ 2,5TF/3,2i/ 2,0 D/ 2,4 D/ D5/ AWD	
	€ 91,40	Kegel sw 19 M14 x 1,5 x 33			
RDKS	ASC; ASS; CUC; CUS; Huf 2.4; Huf 3.4; Huf 3.5; SE1C1; SE1C2; TTC / OE: VDO S180052050Z				
V70 II				B, B-2D, B-N2D, B-N2R	
MAGNA	Interio		IN 706 45 5 08	lichtsilber-lackiert / mattschwarz-lackiert	
	7 J x16 EH2+	205/60R16	☼	ABE	
	5 x 108	215/55R16	☼	ABE	
	ET 45	225/55R16		ABE	
RDKS	ASC; CUC; Huf 2.4; Huf 3.4; Huf 3.5; SE1C1; SE1S			MK 317	
XC60				D, D-2D, D-N2D, D-N2E	
MAGNA	Tezzo		TZ 757 45 5 08	lichtsilber-lackiert / mattschwarz-lackiert	
	7½ J x17 H2	235/60R17	☼	TÜV	Auflagen beachten!
	5 x 108	245/60R17		TÜV	
	ET 45	255/55R17		TÜV	
RDKS	ASC; ASS; CUC; Huf 2.4; Huf 3.4; Huf 3.5; SE1C1; SE1C2; SE1S			MK 317	
XC70 II			09/07-	B, B-2D	
Stahl	VV 516005	8275	163482	Kombi	
	7 J x16 H2	215/65R16		3,2i (175 kW)/ 2,4 D (120 kW)/ D5 (136 kW)	
	5x108x63,3				
	ET 50				
	€ 91,40	Kegel sw 19 M14 x 1,5 x 33			
RDKS	ASC; ASS; CUC; CUS; Huf 2.4; Huf 3.4; Huf 3.5; SE1C1; SE1C2; TTC / OE: VDO S180052050Z				
XC70 II				B, B-2D, B-N2D, B-N2E	
MAGNA	Interio		IN 706 45 5 08	lichtsilber-lackiert / mattschwarz-lackiert	
	7 J x16 H2	215/65R16		ABE	
	5 x 108	225/60R16		ABE	
	ET 45	235/60R16		ABE	
RDKS	ASC; CUC; Huf 2.4; Huf 3.4; Huf 3.5; SE1C1; SE1S			MK 317	



		C, C-2D	XC90		
 TZ	 TZ	lichtsilber-lackiert / mattschwarz-lackiert		Tezzo	TZ 757 45 5 08
		Auflagen beachten!	TÜV	235/65R17	7½ J x17 H2 5 x 108 ET 45
TÜV	245/60R17				
MK 308		ASC ; ASS ; CUC ; Huf 2.4 ; Huf 3.4 ; Huf 3.5 ; SE1C1 ; SE1C2 ; SE1S			RDKS
		L	XC90 (Neues Modell)		
Radabbildung in Vorbereitung				in Vorbereitung	
					RDKS

KRONPRINZ
MAGMA

KRONPRINZ
MAGMA

Zubehör-Kits

Kit-Nr.	Fahrzeug	LK	LZ	Kegelbund- Mutter / Bolzen	Abmessung- Mutter / Bolzen	MAGMA-Zentrierring			MAGMA- Felgen- schloss
						Art.-Nr.	Naben Ø	Außen Ø	
MK 011	Nissan, Opel, Suzuki	100	4	Muttern	M12x1,25	MZ 02	54,1	63,3	MF 001
MK 012	Subaru, Toyota	100	5	Muttern	M12x1,25	MZ 03	56,1	63,3	MF 001
MK 015	Nissan	100	4	Muttern	M12x1,25	MZ 10	60,1	63,3	MF 001
MK 016	Suzuki	114,3	5	Muttern	M12x1,25	MZ 20	60,1	70,0	MF 001
MK 017	Nissan	114,3	4	Muttern	M12x1,25	MZ 24	66,1	70,0	MF 001
MK 018	Nissan, Renault (Koleos)	114,3	5	Muttern	M12x1,25	MZ 24	66,1	70,0	MF 001
MK 030	Daihatsu, Hyundai, Kia, Mazda, Toyota	100	4	Muttern	M12x1,5	MZ 02	54,1	63,3	MF 002
MK 032	Lexus, Toyota	100	5	Muttern	M12x1,5	MZ 02	54,1	63,3	MF 002
MK 033	Daihatsu, Honda, Kia, Mitsubishi	100	4	Muttern	M12x1,5	MZ 03	56,1	63,3	MF 002
MK 034	Chevrolet / Daewoo	100	4	Muttern	M12x1,5	MZ 04	56,6	63,3	MF 002
MK 035	Chevrolet / Daewoo	114,3	4	Muttern	M12x1,5	MZ 14	56,6	70,0	MF 002
MK 036	Chevrolet / Daewoo, Opel	114,3 / 105	5	Muttern	M12x1,5	MZ 14	56,6	70,0	MF 002
MK 037	Chrysler	100	5	Muttern	M12x1,5	MZ 05	57,1	63,3	MF 002
MK 040	Lexus, Toyota	114,3	5	Muttern	M12x1,5	MZ 20	60,1	70,0	MF 002
MK 041	Ford, Mazda	108	4	Muttern	M12x1,5	Serie			MF 002
MK 042	Ford, Jaguar, Volvo	108	5	Muttern	M12x1,5	MZ 21	63,4	70,0	MF 002
MK 044	Honda, Land Rover	114,3	5	Muttern	M12x1,5	MZ 22	64,1	70,0	MF 002
MK 046	Hyundai, Kia, MCC / Smart, Mitsubishi, Volvo	114,3	4	Muttern	M12x1,5	MZ 26	67,1	70,0	MF 002
MK 047	Citroën, Hyundai, Kia, Mazda, Mitsubishi, Peugeot	114,3	5	Muttern	M12x1,5	MZ 26	67,1	70,0	MF 002
MK 048	Chevrolet, Opel	115	5	Muttern	M12x1,5	Serie			MF 002
MK 070	Ford (Galaxy, S-Max), Land Rover	108	5	Muttern	M14x1,5	MZ 21	63,4	70,0	
MK 071	Cadillac (CTS), Opel (Insignia)	120	5	Muttern	M14x1,5	MZ 56	67,1	72,5	
MK 072	Cadillac (CTS), Opel (Insignia)	120	5	Muttern	M14x1,5	MZ 30	67,1	74,1	
MK 101	Peugeot	108	5	Bolzen	M12x1,25x30	MZ 23	65,1	70,0	MF 102
MK 102	Citroën, Peugeot	108	4	Bolzen	M12x1,25x30	Serie			MF 102
MK 103	Alfa Romeo (166)	108	5	Bolzen	M12x1,25x28	MZ 16	58,1	70,0	MF 101
MK 104	Citroën, Fiat, Peugeot	98	4	Bolzen	M12x1,25x28	MZ 06	58,1	63,3	MF 101
MK 105	Fiat, Lancia	98	4	Bolzen	M12x1,25x30	MZ 06	58,1	63,3	MF 102
MK 106	Lada, Skoda	98	4	Bolzen	M12x1,25x28	MZ 07	58,6	63,3	MF 101
MK 107	Citroën, Peugeot	108	5	Bolzen	M12x1,25x28	MZ 23	65,1	70,0	MF 101
MK 109	Fiat, Ford (Ka Typ RU8)	98	4	Bolzen	M12x1,25x26	MZ 06	58,1	63,3	

Kit-Nr.	Fahrzeug	LK	LZ	Kegelbund- Mutter/ Bolzen	Abmessung- Mutter/ Bolzen	MAGMA-Zentrierring			MAGMA- Felgen- schloss
						Art.-Nr.	Naben Ø	Außen Ø	
MK 110	Alfa Romeo, Fiat, Ford (Ka Typ RU8), Lancia	98	4	Bolzen	M12x1,25x26	Serie			
MK 111	Citroën, Fiat, Peugeot	108	4	Bolzen	M12x1,25x28	Serie			MF 101
MK 112	Alfa Romeo (Giulietta)	110	5	Bolzen	M12x1,25x28	Serie			MF 101
MK 201	BMW	120	5	Bolzen	M12x1,5x28	MZ 32	72,6	74,1	MF 202
MK 202	Cadillac, BMW, Opel, Saab	120 / 110	5	Bolzen	M12x1,5x28	Serie			MF 202
MK 203	Fiat (Sedici), Renault, Suzuki	108 / 114,3	5	Bolzen	M12x1,5x28	MZ 20	60,1	70,0	MF 202
MK 205	Seat, Skoda, VW	100	4	Bolzen	M12x1,5x28	MZ 05	57,1	63,3	MF 202
MK 206	Citroën, Kia (Rio), Opel, Peugeot, Suzuki, Toyota	100	4	Bolzen	M12x1,5x28	MZ 02	54,1	63,3	MF 202
MK 207	Fiat (Grande Punto)	100	4	Bolzen	M12x1,5x28	MZ 04	56,6	63,3	MF 202
MK 210	Chevrolet / Daewoo, Opel	100	4	Bolzen	M12x1,5x30	MZ 04	56,6	63,3	MF 203
MK 211	BMW Mini (bis Aug. 2006)	100	4	Bolzen	M12x1,5x28	MZ 03	56,1	63,3	MF 202
MK 215	Chrysler (Crossfire), Mercedes-Benz	112	5	Bolzen	M12x1,5x26	MZ 25	66,6	70,0	
MK 216	Dacia, Nissan, Renault	100	4	Bolzen	M12x1,5x28	MZ 10	60,1	63,3	MF 202
MK 217	Dacia, Nissan, Renault	114,3	5	Bolzen	M12x1,5x28	MZ 24	66,1	70,0	MF 202
MK 302	Mercedes-Benz	112	5	Bolzen	M14x1,5x28	MZ 25	66,6	70,0	MF 302
MK 303	Audi, Seat, Skoda, VW	100	5	Bolzen	M14x1,5x30	MZ 05	57,1	63,3	MF 303
MK 304	Renault	108	5	Bolzen	M14x1,5x30	MZ 20	60,1	70,0	MF 303
MK 305	Volvo	108	5	Bolzen	M14x1,5x30	MZ 23	65,1	70,0	MF 303
MK 306	Audi, Seat, Skoda, VW	112	5	Bolzen	M14x1,5x30	MZ 15	57,1	70,0	MF 303
MK 307	Audi, Mercedes-Benz	112	5	Bolzen	M14x1,5x30	MZ 25	66,6	70,0	MF 303
MK 308	Volvo (XC90)	108	5	Bolzen	M14x1,5x30	MZ 26	67,1	70,0	MF 303
MK 310	Ford, Seat, VW	112	5	Bolzen	M14x1,5x33	MZ 15	57,1	70,0	MF 304
MK 313	Alfa Romeo (159), BMW (X3), Mercedes-Benz (M-Klasse)	110 / 112 / 120	5	Bolzen	M14x1,5x30	Serie			MF 303
MK 314	BMW (7er Typ 765)	120	5	Bolzen	M14x1,5x30	MZ 32	72,6	74,1	MF 303
MK 317	Volvo	108	5	Bolzen	M14x1,5x30	MZ 21	63,4	70,0	MF 303
MK 318	Renault (Laguna Typ T)	114,3	5	Bolzen	M14x1,5x30	MZ 24	66,1	70,0	MF 303
MK 319	Mercedes-Benz (C-Klasse Typ 204)	112	5	Bolzen	M14x1,5x28	Serie			MF 302
MK 320	Audi A6 Allroad (Typ 4B)	112	5	Bolzen	M14x1,5x28	MZ 15	57,1	70,0	MF 302
MK 321	Audi A8 (Typ 4H)	112	5	Bolzen	M14x1,5x30	MZ 25	66,6	70,0	MF 303
MK 402	BMW	120	5	Bolzen	M14x1,25x35	MZ 32	72,6	74,1	

Kit-Nr.	Fahrzeug	LK	LZ	Kegelbund- Mutter / Bolzen	Abmessung- Mutter / Bolzen	MAGMA-Zentrierring			MAGMA- Felgen- schloss
						Art.-Nr.	Naben Ø	Außen Ø	
MK 403	BMW, BMW Mini	120	5	Bolzen	M14x1,25x35	Serie			
MK 404	BMW	120	5	Bolzen	M14x1,25x33	Serie			
MK 405	BMW	120	5	Bolzen	M14x1,25x33	MZ 32	72,6	74,1	
MK 501	Volvo, VW (Amarok, T5, Touareg)	108 / 120	5	Bolzen	Serie	MZ 23	65,1	70,0	
MK 502	BMW (X5 Typ X53)	120	5	Bolzen	Serie	MZ 32	72,6	74,1	
MK 503	BMW Mini (ab Sept. 2006)	100	4	Bolzen	Serie	MZ 03	56,1	63,3	
MK 504	BMW Mini (ab Mrz. 2014)	112	5	Bolzen	Serie	MZ 25	66,6	70,0	
MK 602	VW (Amarok, T5)	120	5	Bolzen	M14x1,5x36	Serie			

MAGMA Räder sind in einigen Fällen fixgebohrt und auf die Verwendung der originalen Serienbefestigung ausgelegt. Meistens werden jedoch Befestigungskits benötigt, die aus Radbolzen bzw. Muttern und/oder Zentrierringen bestehen.













Die Zubehöreile (Radbolzen bzw. - muttern sowie Zentrierringe) sind Bestandteil der ABE.

Die von KRONPRINZ gelieferten Teile dürfen nicht mit dem Zubehör anderer Räderhersteller vermischt oder gegen diese ausgetauscht werden.

Felgenschlösser

Kit-Nr.	Schlüsselweite	Abmessung	Abmessung	Schaftlänge	passend zu Kit
MF 101	17-19	Bolzen	12 x 1,25	28	MK 103, MK 104, MK 106, MK 107, MK 111, MK 112
MF 102	17-19	Bolzen	12 x 1,25	30	MK 101, MK 102, MK 105
MF 202	17-19	Bolzen	12 x 1,50	28	MK 201, MK 202, MK 203, MK 205, MK 206, MK 207, MK 211, MK 216, MK 217
MF 203	17-19	Bolzen	12 x 1,50	30	MK 210
MF 302	17-19	Bolzen	14 x 1,50	28	MK 302, MK 319, MK 320
MF 303	17-19	Bolzen	14 x 1,50	30	MK 303, MK 304, MK 305, MK 306, MK 307, MK 308, MK 313, MK 314, MK 317, MK 318, MK 321
MF 304	17-19	Bolzen	14 x 1,50	33	MK 310
MF 001	17-19	Muttern	12 x 1,25		MK 011, MK 012, MK 015, MK 016, MK 017, MK 018
MF 002	17-19	Muttern	12 x 1,50		MK 030, MK 032, MK 033, MK 034, MK 035, MK 036, MK 037, MK 040, MK 041, MK 042, MK 044, MK 046, MK 047, MK 048

Nabenkappen

MAGMA -Nabenkappen (MN)			Radoberfläche	Farbcode	
MN 013	LK ≤ 100		in schwarz auf silber	lichtsilber-lackiert lichtsilber-poliert	A1 A2
MN 014	LK > 100		in schwarz auf silber	lavaschwarz-poliert titangrau-poliert	B2 C2
MN 015	LK ≤ 100		in chrom auf mattschwarz	mattschwarz-lackiert	D1
MN 016	LK > 100		in chrom auf mattschwarz		
MN 017	LK ≤ 100		in schwarz auf chrom	chrom-lackiert	E1
MN 018	LK > 100		in schwarz auf chrom		
MN 019	LK ≤ 100		in silber auf mattschwarz	lavaschwarz-poliert, matt	D2
MN 020	LK > 100		in silber auf mattschwarz		
MN 021	LK ≤ 100		in chrom auf glänzend schwarz	Interio, Tezzo	B2
MN 022	LK > 100		in chrom auf glänzend schwarz	lavaschwarz-poliert	

DCW-G3 – Die neueste Generation unserer Lkw-Räder



Räder mit Hump

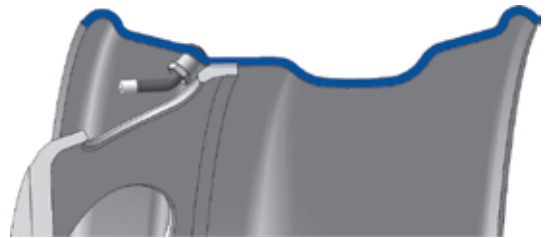

DCW-G3

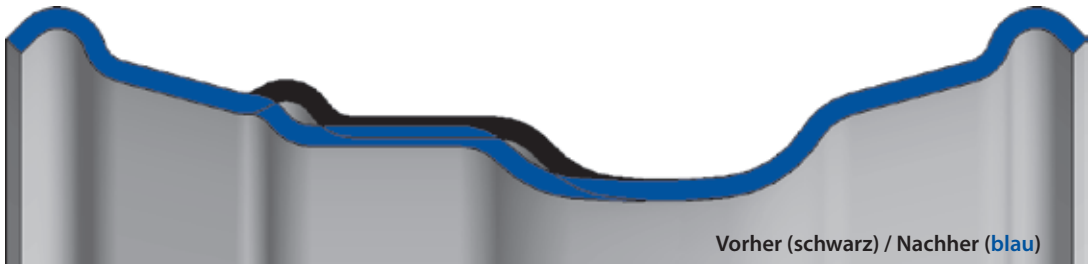

Vorher (schwarz) / Nachher (blau)

Der direkte Vergleich

- ▶ Nochmals verringertes Radgewicht durch neue Kontur, dadurch erhöhte Zuladung möglich
- ▶ Kein Hump – keine Probleme bei der Reifenmontage / -demontage
- ▶ Standard außenliegendes Ventil (ALV) kann benutzt werden
- ▶ Völlig RDKS-kompatibel
- ▶ Verfügbar in allen gängigen Abmessungen
- ▶ Patentierte Entwicklung
- ▶ Europäische Erstausrüsterqualität

Sortiment Steilschulterräder

Anm	LZ	LK	ML	BL	RZ ¹⁾	ET	HMA	Tragfähigkeit (kg)	Fahrzeughersteller	Artikelnummer (alt)	Artikelnummer ³⁾
17.5 x 6.00											
ILV	6	205	161	M18DS32	(MZ)	116,0	125,0	1550	Daimler	803 VB	14020
ALV	6	205	161	M18	MZ	120,0	131,0	1850	Iveco, Paccar, Trailer	8030.83	14000
ALV	6	245	202	M18	MZ	115,0	125,0	1850	Daimler		35038
ALV	6	245	202	M18DS32	(MZ)	115,0	125,0	1700	Daimler		11146
ALV	6	245	191	M20	MZ	121,5	131,0	1850	Iveco		14014
ALV	6	245	202	M18	MZ	121,5	131,0	1850	MAN, Volvo, Trailer	803 WA	14008
ILV	10	225	176	M22	MZ	122,5	133,0	3150	Trailer		35002
ILV	10	225	176	M22IS36	(MZ)	122,5	133,0	3150	Trailer	803 KA	14015
²⁾ 8 R 17.5 / 8.5 R 17.5 / 9 R 17.5 / 9.5 R 17.5 / 205/65 R 17.5 / 205/75 R 17.5 / 215/75 R 17.5 / 225/75 R 17.5											
17.5 x 6.75											
ALV	6	205	161	M18ES32	(MZ)	0		2725	Trailer	806 AB	14019
ALV	6	245	202	M18	MZ	129,0	139,0	2240	Daimler		35037
ALV	6	245	202	M18DS32	(MZ)	129,0	139,0	2000	Daimler		35005
ALV	6	245	202	M18	MZ	134,0	145,0	2360	MAN	805 YA	14009
ALV	8	275	221	M20	MZ	135,5	145,0	2360	Iveco, Trailer	806 EA	14007
ILV	10	225	176	M22IS36	(MZ)	128,2	140,0	3150	Trailer	805 MB	14017
²⁾ 8 R 17.5 / 8.5 R 17.5 / 9 R 17.5 / 9.5 R 17.5 / 205/65 R 17.5 / 205/75 R 17.5 / 215/75 R 17.5 / 225/75 R 17.5 / 235/75 R 17.5 / 245/75 R 17.5											
19.5 x 6.75 U DCW-G3											
ALV	8	275	221	M20	MZ	133,0	145,0	2500	Daimler, Irisbus, Iveco, Paccar, Trailer		35366
ALV	8	275	221	M22DS36	(MZ)	133,0	145,0	2500	Trailer		35367
²⁾ 8 R 19.5 / 8.5 R 19.5 / 9 R 19.5 / 9.5 R 19.5 / 245/70 R 19.5 / 265/70 R 19.5											
19.5 x 7.50											
ALV	10	225	176	M22DS36	(MZ)	0		2725	Trailer	817 BB*	11054*
ILV	10	225	176	M22IS36	(MZ)	139,5	151,0	2725	Trailer	817 GA*	11048*
²⁾ 245/70 R 19.5 / 265/70 R 19.5 / 285/70 R 19.5											
19.5 x 7.50 U DCW-G3											
ALV	8	275	221	M22	MZ	138,0	150,0	2800	Trailer		35368
ALV	8	275	221	M20	MZ	144,0	156,0	3000	Daimler, Iveco, Volvo, MAN, Paccar		35369
ALV	8	275	221	M22DS36	(MZ)	144,0	156,0	3000	Trailer		35370
ALV	10	225	176	M22IS36	(MZ)	139,5	151,0	2725	Trailer		35552
²⁾ 245/70 R 19.5 / 265/70 R 19.5 / 285/70 R 19.5											

Anm	LZ	LK	ML	BL	RZ ¹⁾	ET	HMA	Tragfähigkeit (kg)	Fahrzeughersteller	Artikelnummer (alt)	Artikelnummer ²⁾
19.5 x 8.25											
ALV	8	275	221	B18E532	BZ	0		3800	Trailer		15094*
ILV	10	225	176	M22IS36	(MZ)	147,5	160,0	3150	Trailer	819 GA*	11050*
²⁾ 265/70 R 19.5 / 285/70 R 19.5 / 305/70 R 19.5											
19.5 x 8.25 U DCW-G3											
ALV	8	275	221	B18E532	BZ	0		3800	Trailer		35554
ALV	8	275	221	M22	MZ	65,0		3150	Trailer		35555
ALV	8	275	221	M20	MZ	157,0	170,0	3150	Daimler, Iveco, MAN, Paccar		35371
ALV	10	225	176	M22	MZ	66,0		3750	Trailer		35553
ALV	10	225	176	M22IS36	(MZ)	147,5	160,0	3350	Trailer		35503
²⁾ 265/70 R 19.5 / 285/70 R 19.5 / 305/70 R 19.5											
19.5 x 11.75											
ALV	8	275	221	M22	MZ	0		4500	Trailer		35423
ALV	10	335	281	M22	MZ	0		4500	Trailer		35421
ALV	10	335	281	M22	MZ	120,0		4500	Trailer		35422
²⁾ 385/55 R 19.5 / 385/65 R 19.5											
19.5 x 14.00											
ALV	8	275	221	M22	MZ	0		4500	Trailer		35426
ALV	10	335	281	M22	MZ	0		4500	Trailer		35424
ALV	10	335	281	M22	MZ	120,0		4500	Trailer		35425
²⁾ 425/55 R 19.5 / 435/50 R 19.5 / 445/45 R 19.5 / 445/65 R 19.5											
22.5 x 6.75											
ILV	8	275	221	M20	MZ	132,0	143,0	2800	Irisbus, Iveco, Volvo, Renault, Trailer	11038	15130
ILV	10	335	281	M22	MZ	130,0	140,0	2800	Renault, Trailer		11039*
²⁾ 8 R 22.5 / 9 R 22.5 / 10 R 22.5 / 255/70 R 22.5											
22.5 x 7.50											
ALV	8	275	221	M20	MZ	141,5	153,0	3150	Daimler, MAN, Leichtversion		15096
ALV	8	275	221	M20	MZ	141,5	153,0	3150	Daimler, Allrad - Trommelbremse	848 LA*	15014*
ALV	8	275	221	M20	MZ	147,0	160,0	3250	Iveco, Trailer	848 PA*	15016*
ALV	10	335	281	M22	MZ	148,0	160,0	3250	Irisbus, Iveco, Paccar, Scania, Volvo, Renault, Trailer	848 SA*	15019*

Anm	LZ	LK	ML	BL	RZ ¹⁾	ET	HMA	Tragfähigkeit (kg)	Fahrzeughersteller	Artikelnummer (alt)	Artikelnummer ³⁾
22.5 x 7.50											
ALV	10	335	281	B22DS36	BZ	153,0	165,0	3250	Daimler, Trailer	848 RB*	15018*
ALV	10	335	281	M22	MZ	153,0	165,0	3250	MAN, Daimler, Trailer	848 RA*	15017*
²⁾ 10 R 22.5 / 11 R 22.5 / 255/70 R 22.5 / 275/70 R 22.5 / 275/80 R 22.5											
22.5 x 7.50 U DCW-G3											
ALV	8	275	221	M20	MZ	147,5	160,0	3250	Iveco, Trailer		15124
ALV	10	335	281	M22	MZ	88,0		3550	Trailer		15123
ALV	10	335	281	M22	MZ	147,5	160,0	3750	Irisbus, Iveco, Paccar, Scania, Volvo, Renault, Trailer		15121
ALV	10	335	281	M22	MZ	152,5	165,0	3750	Daimler, MAN, Trailer		15107
²⁾ 10 R 22.5 / 11 R 22.5 / 255/70 R 22.5 / 275/70 R 22.5 / 275/80 R 22.5											
22.5 x 8.25											
ALV	10	335	281	B22DS36	BZ	152,0	165,0	3550	MAN, Daimler, Neoplan, Trailer	850 RB*	15025*
ALV	10	335	281	M22	MZ	152,0	165,0	3550	MAN, Daimler, Tatra, Trailer	850 RA*	15024*
ALV	10	335	281	M22	MZ	157,0	170,0	3550	Irisbus, Iveco, Paccar, Scania, Volvo, Renault, Trailer	850 SA*	15000*
²⁾ 11 R 22.5 / 12 R 22.5 / 255/70 R 22.5 / 275/70 R 22.5 / 275/80 R 22.5 / 295/80 R 22.5 / 305/70 R 22.5											
22.5 x 8.25 U DCW-G3											
ALV	10	335	281	M22	MZ	152,5	165,0	3750	Daimler, MAN, Trailer		15098
ALV	10	335	281	M22	MZ	157,5	170,0	3750	Irisbus, Iveco, Paccar, Scania, Volvo, Renault, Trailer		15119
²⁾ 11 R 22.5 / 12 R 22.5 / 255/70 R 22.5 / 275/70 R 22.5 / 275/80 R 22.5 / 295/80 R 22.5 / 305/70 R 22.5											
22.5 x 9.00											
ALV	10	335	281	M22	MZ	161,0	175,0	4500	Daimler, Paccar, Scania, Trailer	852 TA	15005
ALV	10	335	281	M22	MZ	162,5	175,0	4000	Trailer	852 XA*	15041*
²⁾ 12 R 22.5 / 13 R 22.5 / 285/60 R 22.5 / 295/60 R 22.5 / 295/80 R 22.5 / 305/60 R 22.5 / 305/70 R 22.5 / 315/60 R 22.5 / 315/70 R 22.5 / 315/75 R 22.5 / 315/80 R 22.5											
22.5 x 9.00 U DCW-G3											
ALV	10	335	281	M22	MZ	120,0		4000	Trailer		35470
ALV	10	335	281	M22	MZ	162,5	175,0	4000	Daimler, MAN, Irisbus, Iveco, Paccar, Scania, Trailer		15099
²⁾ 12 R 22.5 / 13 R 22.5 / 285/60 R 22.5 / 295/60 R 22.5 / 295/80 R 22.5 / 305/60 R 22.5 / 305/70 R 22.5 / 315/60 R 22.5 / 315/70 R 22.5 / 315/75 R 22.5 / 315/80 R 22.5											

Anm	LZ	LK	ML	BL	RZ ¹⁾	ET	HMA	Tragfähigkeit (kg)	Fahrzeughersteller	Artikelnummer (alt)	Artikelnummer ³⁾
22.5 x 9.75											
ALV	10	335	281	M22	MZ	162,5	175,0	3550	Daimler, Man, DAF, Scania, Iveco		15081
²⁾ 315/45 R 22.5											
22.5 x 11.75											
ALV	10	335	281	M22	MZ	REV		5000	Trailer	857 BA	35511
ALV	10	335	281	M22S36	(MZ)	0		5000	Trailer		35054
ALV	10	335	281	M22	MZ	0		5000	Trailer		15084
ALV	10	335	281	M22	MZ	45,0		5000	Trailer	857 BC	15122
ALV	10	335	281	M22	MZ	120,0		5000	Trailer, Volvo, MAN, Daimler		15083
ALV	10	335	281	M22	MZ	135,0		5000	Iveco, Paccar, Scania, Trailer		15073
ALV	10	335	281	M22	MZ	140		3550	Bus		15125
ALV	10	335	281	M22	MZ	160,0		4750	Daimler		15126
²⁾ 15 R 22.5 / 350/75 R 22.5 / 365/70 R 22.5 / 385/65 R 22.5											
22.5 x 13.00											
ALV	10	335	281	M22	MZ	0		5150	Trailer		35527
ALV	10	335	281	M22	MZ	120,0		5150	MAN, Daimler, Trailer	861 GA*	11063*
ALV	10	335	281	M22	MZ	120,0		5150	MAN, Daimler, Trailer		35526
²⁾ 16.5 R 22.5 / 425/65 R 22.5											
22.5 x 15.00											
ALV	10	335	281	M22	MZ	0		5300	Trailer		11108
ALV	10	335	281	M22	MZ	120,0		5300	Trailer	11107	14003
²⁾ 455/45 R 22.5											
24 x 8.50											
ALV	10	335	281	M22	MZ	160,5	175,0	5000	MAN, Scania, DAF, Trailer		15068
ALV	10	335	281	M22	MZ	163,5	178,0	5000	Volvo, Daimler, Trailer		15065
²⁾ 325/95 R24, 12.00 R24											

Hinweise:

¹⁾ BZ = Bolzenzentriert | MZ = Mittenzentriert | (MZ) = Mischzentriert

²⁾ Die Angaben basieren auf Veröffentlichungen der Hersteller und erfolgen ohne Gewähr!

³⁾ Mit * gekennzeichnete Räder sind nur noch im Rahmen verfügbarer Lagerbestände lieferbar.

Zoll-Größe	Artikel-Nr. Kronprinz	Artikel-Nr. Südrad	Radgröße	LZ	LK	NB	ET	Bolzenloch-ausführung	max. Traglast in kg
8 Zoll	RP 508003	601002	2,50 A x 8	4	100	60	0	Kugel	275
	RP 508002	603000	3,00 D x 8	4	100	60	0	Kugel	335
10 Zoll	RP 510001	602804	3,50 B x 10 H2	4	100	60	0	Kegel	350
	RP 510002	602805	3,50 B x 10 H2	4	100	60	0	Kugel	350
	RP 510003	604608	6,00 I x 10 H2	5	112	67	-4	Kugel	750
12 Zoll	RP 512001	43060106	4,00 J x 12 H2	4	100	57	0	Kugel	450
	RP 512002	43186102	4,00 J x 12 H2	4	100	57	26	Kugel	450
	RP 512003	43055100	4,50 J x 12 H2	5	112	67	0	Kugel	900
	RP 512004	43114104	4,50 J x 12 H2	5	112	67	20	Kugel	900
	RP 512005	43125107	4,50 J x 12 H2	5	112	67	30	Kugel	900
13 Zoll	RP 513001	43447107	4,00 J x 13 H2	4	100	57	30	Kegel	615
	RP 513002	43107105	4,50 J x 13 H2	4	100	57	30	Kegel	670
	RP 513012	43496107	4,50 J x 13 H2	4	100	57	30	Kugel	675
	RP 513003	43166107	4,50 J x 13 H2	5	112	63	30	Kegel	675
	RP 513004	43200102	4,50 J x 13 H2	5	112	66,5	30	Kugel	675
	RP 513005	43191108	4,50 J x 13 H2	5	112	63	33	Kegel	710
	RP 513006	43201103	5,00 J x 13 H2	4	100	57	30	Kegel	675
	RP 513008	43203105	5,00 J x 13 H2	5	112	66,5	30	Kugel	700
	RP 513010	43674107	5,50 J x 13 H2	5	112	66,5	30	Kugel	900
	RP 513011	43687102	6,00 J x 13 H2	5	112	66,5	30	Kugel	900
14 Zoll	RP 514001	43508104	5,00 J x 14 H2	5	112	63	26	Kegel	775
	RP 514002	43354102	5,00 J x 14 H2	5	112	66,5	30	Kugel	775
	RP 514003	43070108	5,50 J x 14 H2	4	100	57	30	Kegel	775
	RP 514004	43072101	5,50 J x 14 H2	5	112	66,5	30	Kugel	950
	RP 514007	43361101	6,00 J x 14 H2	5	112	66,5	30	Kugel	950
	RP 514008	43292104	6,00 J x 14 H2	6	205	161	-5	Kugel	1250
	RP 514009	43292104	6,00 J x 14 H2	6	205	161	-5	Kugel	1250
15 Zoll	RP 515001		5,50 J x 15 H2	5	112	66,5	30	Kugel	800
	RP 515002	43130104	6,00 J x 15 H2	5	112	66,5	30	Kugel	900
	RP 515004	43131105	6,00 J x 15 H2	5	112	66,5	30	Kegel	900
16 Zoll	RP 516001	43220106	6,00 J x 16 H2	5	112	66,5	30	Kugel	900

Wichtig: Die Anhängerräder sind ausschließlich für den Anhängerbetrieb geprüft. Die Verwendung auf Personenkraftwagen ist nicht zulässig. Die angegebene Traglast bezieht sich ausschließlich auf die Verwendung im Anhängerbetrieb.

Die Räderrichtlinie

An dieser Stelle möchten wir Sie über eine für das Umrüstgeschäft wichtige Änderung in der Straßenverkehrsulassungsordnung (StVZO) informieren. Nachdem die alte Räderrichtlinie „Richtlinien für die Prüfung von Sonderrädern für Personenkraftwagen

und für Krafträder“ vom 27. Juli 1982 überarbeitet wurde, ist seit Dezember 1998 die neue „Richtlinie für die Prüfung von Sonderrädern für Kraftfahrzeuge und ihre Anhänger“ (§ 30 StVZO) in Kraft.

Originalräder

Sind Räder, die von den Automobilherstellern oder deren markengebundener Ersatzteilorganisation verbaut werden und in der Betriebserlaubnis des Fahrzeugs enthalten sind.

Standardräder

Stimmen in Form, Abmessungen und Werkstoff mit dem Originalrad überein und sind von der Betriebserlaubnis des Fahrzeuges erfasst. Einziger Unterschied: fehlende Stempelung von Warenzeichen und Teilenummer des Fahrzeugherstellers.

Sonderräder

Sind nicht in der Fahrzeug-Betriebserlaubnis enthalten und entsprechen nicht den Originalrädern. Sie erfordern eine ABE und sind somit eintragungspflichtig bzw. unterliegen der Mitföhrpflicht der ABE-Dokumente.

Originalräder

Definition unverändert.

Identräder

Unterliegen der Sonderradrichtlinie, benötigen daher eine ABE. Für Identräder gelten vereinfachte Prüf- und Genehmigungsverfahren, so dass keine Mitföhrpflicht für ABE-Dokumente besteht. Identräder sind Originalräder, bei denen für den Nachrüstmak auf eine Stempelung des Warenzeichens und/oder der Teilenummer des Fahrzeugherstellers verzichtet wird.

Nachbauräder

Sind Stahlscheibenräder und unterliegen der Sonderradrichtlinie, benötigen daher eine ABE. Für Nachbauräder gelten vereinfachte Prüf- und Genehmigungsverfahren und es besteht keine Mitföhrpflicht für ABE-Dokumente.

Nachbauräder werden nach OE-Spezifikationen dem serienmäßig angebauten und mit der Betriebserlaubnis des Fahrzeuges genehmigten Rad nachgebaut und entsprechen in allen Maßen, Werkstoff und Standfestigkeit den in Serie montierten Rädern.

Sonderräder

Definition unverändert.

Generell gilt:

- Bis zum Produktionsdatum 30. September 1999 konnte weiterhin entsprechend den „Richtlinien für die Prüfung von Sonderrädern für Personenkraftwagen und für Krafträder“ vom 27. Juli 1982 (VkB1. 1982 Seite 276) verfahren werden.
- Für Sie ist daher das Fertigungsdatum der Räder entscheidend:
Alle ab dem 01. Oktober 1999 gefertigten Ident- und Nachbau-Räder müssen mit einer ABE-Nummer (z. B. KBA 43815) gekennzeichnet sein.
- Räder die vor dem 01. Oktober 1999 gefertigt wurden, erfordern keine Kennzeichnung mit einer ABE-Nummer, dürfen aber auch nach dem 01. 10. 1999 uneingeschränkt im Markt vertrieben werden.

Das heißt für Sie:

- Alle von KRONPRINZ vertriebenen Räder erfüllen die Qualitätsanforderungen der Erstausrüstung.
- Sie sind identisch zu den Originalrädern (also entweder ein Original-, Ident- oder Nachbaurad) und somit nicht eintragungspflichtig.
- Bei Verwendung unserer Handelsräder ist der Fahrzeughalter generell von der Mitführungspflicht der ABE-Dokumente befreit.
- Wir gewährleisten durch unsere Verkaufsunterlagen, dass den Vertriebsstellen alle erforderlichen Informationen zur Bestimmung des zulässigen Verwendungsbereiches der Räder zugänglich sind.
- Bei sachgemäßer Verwendung von KRONPRINZ-Rädern erlischt die allgemeine Betriebserlaubnis und der Versicherungsschutz des Fahrzeuges nicht.

Sicherheits- und Wartungshinweise für den Gebrauch von Rädern in Reifenwerkstätten

Entwickelt durch die EUWA – Verband der Europäischen Hersteller von Fahrzeugrädern.

Mitglieder der EUWA sind alle bedeutenden Hersteller von Rädern, für alle Fahrzeugtypen.

1 GELTUNGSBEREICH

Diese EUWA Richtlinie gibt Sicherheitshinweise für den Gebrauch und die Montage von Rädern. Die EUWA beabsichtigt, mit diesen Hinweisen das Montagepersonal über Gefahren und Risiken zu informieren, die in Verbindung mit ihrer Tätigkeit stehen, und die den Verbraucher betreffen können.

Weitere Informationen für Reifenhändler und Montagepersonal können den allgemeinen „Sicherheits- und Wartungsempfehlungen für Räder“ der EUWA entnommen werden.

2 ANWENDUNGSBEREICH

Die folgende Richtlinie hat Gültigkeit für Fahrzeugräder, die von EUWA Mitgliedern hergestellt oder vermarktet werden, insbesondere für Pkw-Räder. Sie bezieht sich auf Handhabung, Montage und Demontage dieser Räder.

3 ALLGEMEINE ANWEISUNGEN

3.1 | Das Rad ist ein hochbeanspruchtes Fahrzeugteil, welches im Betrieb extremen Belastungen ausgesetzt sein kann. Falsche oder nicht sichere Rad/Reifen-Bedienungspraktiken können zu Risiken und Gefahren für den Verbraucher führen. Deshalb müssen alle Wartungs- und Montagearbeiten durch qualifiziertes, fähiges und entsprechend geschultes Personal durchgeführt werden.

3.2 | Die Bedienungsanleitungen, Handbücher sowie die Nutzungs- und Wartungsempfehlungen der Fahrzeug- und Räderhersteller sind zu be-

achten. Es dürfen nur Räder und Komponenten verwendet werden, die vom Fahrzeughersteller freigegeben sind oder deren Konformität – im Fall von After-Market-Rädern – mittels TÜV-Gutachten und KBA-Nummer nachgewiesen wird.

3.3 | Vermeiden Sie Beschädigungen oder Verformungen durch das Aufbringen hoher Kräfte oder durch Schläge während aller Operationen wie Handhabung, Transport, Ventilmontage, Reifenmontage, Auswuchten und der Montage am Fahrzeug.

- ▶ Gefahr eingeschränkter Lebensdauer.
- ▶ Gefahr von Laufunruhe und Vibrationen.

3.4 | Bei all diesen Operationen müssen Stöße oder Kratzer vermieden werden, die den Oberflächenschutz des Rades beschädigen können.

- ▶ Gefahr von Korrosion, die zu einer eingeschränkten Lebensdauer führen kann.

4 MONTAGE DER RAD-/REIFENEINHEIT AN DAS FAHRZEUG

4.1 | Bei der Montage am Fahrzeug muss die Rad-/Reifeneinheit korrekt zur Nabe ausgerichtet werden. Stellen Sie sicher, dass alle Kontaktflächen von Nabe und Rad sauber sind und sich keine Fremdkörper zwischen Rad und Nabe befinden.

- ▶ Gefahr von Laufunruhe und Vibrationen.
- ▶ Gefahr von Beschädigungen des Rades in einem stark beanspruchten Bereich, Gefahr eingeschränkter Lebensdauer.
- ▶ Unzureichendes Anziehen kann zum Lösen des Rades führen.

4.2 | Die folgenden Merkmale des Rades müssen geprüft werden, um die richtige Zuordnung zur Radnabe und zum Fahrzeug sicherzustellen:

- Mittenlochdurchmesser
- Bolzenlochdurchmesser
- Anzahl und Form der Bolzenlöcher
- Einpresstiefe
- Typ und Art der Schrauben oder Muttern
- Felgenabmessung
- Rad/Fahrzeugzuordnung (Fahrzeugmodell, -motorisierung, Baujahr etc.)

4.3 | Alle Befestigungselemente wie Radmuttern und Radschrauben in Kegel- oder Kugelausführung, sowie spezielles Anbaubehör für Stahl- oder Leichtmetallräder, müssen genau zu dem zu montierenden Rad passen. Jede falsche Zuordnung von Teilen (verschiedene Typen, unterschiedliche Form, verschiedene Länge) kann ein Lösen der Schrauben/Muttern oder den Ausfall des Rades verursachen.

- ▶ **Es besteht die Gefahr, ein Rad zu verlieren. Unfallgefahr!**

4.4 | Die Gewinde von Radmuttern und -schrauben können zur Vorbeugung gegen Rost leicht eingölt werden. Eine zu starke Schmierung muss vermieden werden.

- ▶ **Eine übermäßige Schmierung kann zum Lösen des Rades führen.**

4.5 | Die Schrauben oder Muttern aller Scheibenräder müssen mit dem in den Bedienungsanleitungen der Fahrzeughersteller geforderten Anzugsdrehmoment befestigt werden. Es wird empfohlen, einen Drehmomentschlüssel zu verwenden, und die Radschrauben schrittweise und nicht in einem Durchgang anzuziehen.

- ▶ **Übermäßiges Anziehen der Befestigungselemente kann zu Verformungen der Radschüssel oder zu Ausfällen der Schrauben oder Muttern führen.**
- ▶ **Unzureichendes Anziehen kann zum Lösen des Rades führen.**

4.6 | Die richtige Befestigungsreihenfolge ist kreuzweise über die Radmitte: Erst eine Schraube/Mutter anziehen, dann die gegenüberliegende oder die am weitesten entfernte.

- ▶ **Anziehen im Uhrzeigersinn oder gegen den Uhrzeigersinn kann zu Verformungen der Radschüssel und zu Vibrationen führen.**

4.7 | An einem neuen Fahrzeug und bei jedem Rad/Reifenwechsel ist es unbedingt erforderlich, das Anzugsdrehmoment nach ca. 50-100 km Fahrleistung zu überprüfen und, falls nötig, die Radschrauben erneut bis zum richtigen Wert anzuziehen.

- ▶ **Unzureichendes Anziehen kann zum Lösen des Rades führen.**

5 MONTAGE DER RAD- ODER NABENKAPPEN

5.1 | Die Montage der Rad- oder Nabenkappe sollte keine übermäßigen Kräfte erfordern, die zu Beschädigungen der Radlackierung führen könnten.

- ▶ **Gefahr von Korrosion.**

5.2 | Die Radkappe muss in der richtigen Position zum Ventil angebracht werden, um Schäden am Ventil oder das Verbiegen des Ventils zu vermeiden.

5.3 | Der ordnungsgemäße Festsitz der Radkappe ist zu überprüfen, um ihren eventuellen Verlust und einen Hitzestau an der Bremse zu vermeiden.

6 DEMONTAGE DES RADES UND ÜBERPRÜFUNG

6.1 | Folgen Sie den Anweisungen des Fahrzeugherstellers bezüglich der Demontage der Rad/Reifeneinheit.

Alle Einzelteile sind nach der Demontage gründlich zu überprüfen, um sicherzustellen, dass sie in gutem Zustand sind und keine Fehler oder Schäden aufweisen.

- 6.2** | Das Rad als ein Sicherheitsteil darf keine Risse, Brüche, Verformungen, starke Rostbildungen, übermäßige Abnutzungserscheinungen oder ähnliche Fehler aufweisen. Entsprechende Teile müssen ersetzt und verschrottet werden. Auch im Falle eines vermuteten Schadens, z. B. durch ein tiefes Schlagloch oder durch ein überfahrendes Hindernis, ist das betreffende Teil zu ersetzen.
- 6.3** | Der Ersatz muss durch ein Rad erfolgen, das absolut identische Merkmale aufweist.

Typische Fehler oder Schäden, die einen Ersatz des Rades erforderlich machen:

- ▶ Risse in der Radschüssel. Hier können vor allem der Bolzenlochbereich oder der Bereich um die Belüftungslöcher betroffen sein.
 - ▶ Verformungen sowie anormale Eindrücke oder Setzerscheinungen im Bolzensitzbereich.
 - ▶ Verbogene oder verformte Felgenhörner (allgemein durch Stöße gegen Hindernisse).
 - ▶ Undichtigkeiten, hervorgerufen durch Mikrorisse in der Felge oder durch Verschleiß und Absätze in der Berührungsfläche zwischen Reifen und Felge.
 - ▶ Übermäßiger Verschleiß in der Kontaktfläche zur Radnabe oder an den Felgenhörnern.
 - ▶ Starke Rostbildung an der Felge oder im Bereich der Belüftungslöchkanten.
- 6.4** | Jegliche technische Änderung an Rädern ist unzulässig. Beschädigte oder verformte Räder dürfen nicht repariert werden, weder durch Erhitzen, noch durch Schweißen oder durch Hinzufügen oder Entfernen von Material.
- ▶ Es besteht die Gefahr eingeschränkter Lebensdauer oder vorzeitigen Ausfalls.

KRONPRINZ ist Urheber dieses Kataloges einschließlich aller seiner Teile. Jede Verwertung ohne Zustimmung von KRONPRINZ ist unzulässig. Dies gilt insbesondere für Kopien, Übernahme von Teilen des Inhaltes und der Darstellung, die auszugsweise Wiedergabe und die Einspeicherung und Verarbeitung in Systemen.

Alle Lieferungen erfolgen gemäß unseren aktuellen Lieferbedingungen.

Bei den Preisangaben handelt es sich um unverbindliche Preisempfehlungen zzgl. der gesetzlichen MwSt.; Preisänderungen vorbehalten.

Angaben über Eigenschaften und Verfügbarkeit der Produkte entsprechen dem Stand der Drucklegung. Mit * gekennzeichnete Räder sind nur noch im Rahmen verfügbarer Lagerbestände lieferbar.

Änderungen und Irrtum vorbehalten.

Solingen, August 2015

Haben Sie technische Fragen? Dann können Sie direkt mit uns in Kontakt treten:

KRONPRINZ direkt:

Telefon: +49 (0)212 / 701 2613

Fax: +49 (0)212 / 701 2287

E-Mail: service@kronprinz-raederport.com

KRONPRINZ interaktiv:

www.kronprinz-raederport.com

www.magma-wheels.com

www.identrad.de

KRONPRINZ Vertriebspartner: www.kronprinz-raederport.com

KRONPRINZ
MAGMA **KRONPRINZ**



www.kronprinz-raederport.com
www.magma-wheels.com

mefro wheels 

